

Retrofitting Combined Space and Water Heating Systems: Laboratory Tests

B. Schoenbauer, D. Bohac, P. Huelman,
R. Olson, and M. Hewett
NorthernSTAR

October 2012

NOTICE

This report was prepared as an account of work sponsored by an agency of the United States government. Neither the United States government nor any agency thereof, nor any of their employees, subcontractors, or affiliated partners makes any warranty, express or implied, or assumes any legal liability or responsibility for the accuracy, completeness, or usefulness of any information, apparatus, product, or process disclosed, or represents that its use would not infringe privately owned rights. Reference herein to any specific commercial product, process, or service by trade name, trademark, manufacturer, or otherwise does not necessarily constitute or imply its endorsement, recommendation, or favoring by the United States government or any agency thereof. The views and opinions of authors expressed herein do not necessarily state or reflect those of the United States government or any agency thereof.

Available electronically at <http://www.osti.gov/bridge>

Available for a processing fee to U.S. Department of Energy
and its contractors, in paper, from:

U.S. Department of Energy
Office of Scientific and Technical Information
P.O. Box 62
Oak Ridge, TN 37831-0062
phone: 865.576.8401
fax: 865.576.5728

email: <mailto:reports@adonis.osti.gov>

Available for sale to the public, in paper, from:

U.S. Department of Commerce
National Technical Information Service
5285 Port Royal Road
Springfield, VA 22161
phone: 800.553.6847
fax: 703.605.6900

email: orders@ntis.fedworld.gov

online ordering: <http://www.ntis.gov/ordering.htm>



Retrofitting Combined Space and Water Heating Systems: Laboratory Tests

Prepared for:

The National Renewable Energy Laboratory

On behalf of the U.S. Department of Energy's Building America Program

Office of Energy Efficiency and Renewable Energy

15013 Denver West Parkway

Golden, CO 80401

NREL Contract No. DE-AC36-08GO28308

Prepared by:

B. Schoenbauer, D. Bohac, P. Huelman,

R. Olsen, and M. Hewett

NorthernSTAR Building America Partnership

322 Kaufert Lab

2004 Folwell Avenue

Saint Paul, MN 55108

NREL Technical Monitor: Stacey Rothgeb

Prepared under Subcontract No. KNDJ-0-40338-00

October 2012

Acknowledgments

This report was prepared for the U.S. Department of Energy Building America program. Funding for this work was provided by the National Renewable Energy Laboratory under contract KNDJ-0-40338-00. Additional funds to support this work were provided by the Weatherization Assistance Program through a Sustainable Energy Resources for Consumers grant, the Center for Energy and Environment, and the Energy Conservatory. Additional support through loaned or donated equipment was provided from Rinnai, A.O. Smith, American Water Heaters, Eternal, Heat Transfer Products, Navien America, Enerzone, Lifebreath, NuAire, and Advanced Distributor Products.

The primary authors were Ben Schoenbauer, Dave Bohac, and Martha Hewett, Center for Energy and Environment, and Jake McAlpine, Sustainable Resource Center.

These authors would like to acknowledge the contributions and support of Becky Olson, Sustainable Resource Center, for project management and cost analysis; Pat Huelman, University of Minnesota, for expertise and role as an advisor to the project; Alex Haynor, Corinne Wichser, and Josh Novacheck, Center for Energy and Environment for work on field installations and data analysis; Anna Jursik, Center for Energy and Environment for report editing; Gary Nelson, The Energy Conservatory for donating space for the laboratory and his time as an advisor; Gary Klein, Affiliated International Management, for his time and expertise; Louise Goldberg, University of Minnesota–BBE, for the BEopt modeling and analysis; and Tom Schirber, University of Minnesota, for coordinating and editing reports.

Contents

Acknowledgments	iv
List of Figures	vi
List of Tables	vii
Definitions	viii
Executive Summary	ix
Introduction	ix
Experiment	ix
Analysis	ix
Results	ix
Conclusions	xi
1 Introduction	1
1.1 Background	2
1.2 Relevance to Building America’s Goals	3
1.3 Cost Effectiveness	3
1.4 Tradeoffs and Other Benefits	4
1.5 The Role of Combi Systems in Low Income Weatherization	4
2 Experiment	5
2.1 Research Questions	5
2.2 Technical Approach	5
2.3 Measurements	6
2.4 Combi Equipment and Test Instrumentation	8
3 Analysis	12
3.1 Standby Loss and Steady-State Efficiency Analysis	12
3.2 Air Handler Capacity Analysis	13
3.3 Full System Analysis	13
3.4 Error Analysis	13
4 Results	15
4.1 Standby Loss	15
4.2 Steady-State Efficiency	18
4.3 Air Handler Capacity	19
4.4 Full System	23
4.4.1 Maximum Capacity	26
4.4.2 Response to Overlapping Events	27
4.4.3 Domestic Hot Water Supply Temperature	29
4.5 Installation Process and Specifications	32
5 Discussion	35
5.1 Air Handler Improvement	35
5.2 Heating Plant Improvement	35
6 Conclusions	37
7 References	38

List of Figures

Figure 1. Energy consumption during standby mode operation at a set point of 140°F, except Boiler 2, which has a fixed internal hot water set point of 156°F	x
Figure 2. Heating plant steady-state space heating efficiency over a range of return water temperatures	xi
Figure 3. Diagram of a combined space and water heating system.....	1
Figure 4. Test setup for the heating plant with a simulated AH	7
Figure 5. Test setup for the AH testing	8
Figure 6. Photos of test laboratory with combi system installations and venting terminations.....	11
Figure 7. Energy consumption during standby mode at a set point of 140°F	16
Figure 8. Infrared and visual images of Boiler 4 in standby operation	16
Figure 9. Infrared and visual images of TWH 1 in standby operation	17
Figure 10. Infrared and visual images of TWH 2 in standby operation	17
Figure 11. Heating plant steady-state efficiency over a range of return water temperatures.....	18
Figure 12. Heating plant steady-state efficiency for 60 kBtu/h heating load	19
Figure 13. AH7 performance mapping test of supply air temperature	20
Figure 14. AH7 performance mapping test of return water temperature	21
Figure 15. AH7 performance mapping test of space heating capacity	21
Figure 16. AH6 measured and manufacturer specified water temperature difference	23
Figure 17. Maximum capacity test profile for full system tests	24
Figure 18. DHW interrupt load profile for full system tests	24
Figure 19. Low use load profile for full system tests	25
Figure 20. Difference in supply temperature from the start to end of a two shower and space heating demand	27
Figure 21. DHW supply temperature response when space heating demand was initiated.....	28
Figure 22. DHW temperature changes before and after the mixing valve for TWH 1	29
Figure 23. DHW supply temperature profile for a short 1.2-gpm draw.....	30
Figure 24. DHW supply temperature profile for TWH 2	31
Figure 25. Typical outdoor setback temperature control curve.....	34
Figure 26. Typical combi system installation with a boiler	36

Unless otherwise indicated, all figures were created by NorthernSTAR.

List of Tables

Table 1. Laboratory Instrumentation.....	9
Table 2. Laboratory Tested Combi Heating Plants.....	9
Table 3. Laboratory Tested Hydronic AHs	10
Table 4. Standby Site Energy Consumption at a Set Point Temperature of 140°F	15
Table 5. Sizing Chart for AHs for a 140°F Supply Water Temperature	22
Table 6. Full System Test Load Profiles (Btu/h).....	25
Table 7. DHW Draw Characteristics for the Low Use Load Profile	29
Table 8. DHW Performance of Combi Systems Under Small and/or Short Draw Conditions	31
Table 9. Combi System Sizing Chart.....	33

Unless otherwise indicated, all tables were created by NorthernSTAR.

Definitions

AFUE	Annual fuel utilization efficiency
AH	Air handler
BEopt™	Building Energy Optimization (software program)
cfm	Cubic feet per minute
Combi	Combined space and water heating system
DHW	Domestic hot water
EF	Energy factor
gpm	Gallons per minute
TWH	Tankless water heater
WH	Water heater

Executive Summary

Introduction

Better insulation and tighter envelopes reduce space heating loads for new and existing homes. For many homes, decreased space heating loads enable a single heating plant to provide space and domestic water heating loads. These systems, called integrated appliances or combination (combi) systems, can also eliminate safety issues associated with natural draft appliances by using one common sealed combustion vent.

The research will use combi systems with water heater (WH) or boiler heating plants teamed with forced air distribution space heating systems. In each house, the existing furnace will be replaced with a hydronic air handler (AH) that includes an AH, a water coil, and a water pump to circulate water between the heating plant and the coil. The tank type WH will be replaced by either a WH or a boiler with a separate circuit for domestic hot water (DHW). Various options for DHW priority, DHW tempering, and heating plant temperature set point control will be considered.

Experiment

Initial bids indicated that local mechanical contractors had only limited experience in the design and installation of high efficiency combi systems. The NorthernSTAR combi laboratory was created to identify proper system components, designs, operating parameters, and installation procedures to ensure field installed systems are highly efficient. The laboratory also provided a place for contractors, utility representatives, weatherization agents, and codes officials to view the systems and become familiar with their installation. Nine heating plants were installed in the laboratory space. Four condensing combi boilers with heating loops for space and domestic water heating (Boiler 1, Boiler 2, Boiler 3, and Boiler 4) were tested. Two (Boiler 2 and Boiler 4) had internal storage for hot water. Three condensing storage tank type WHs were installed (Tank 1, Tank 2, and Tank 3): one condensing tankless water heater (TWH 1) and a condensing hybrid WH that has a 199,000 Btu/h modulating burner and 2 gal of storage capacity (TWH 2).

Analysis

Laboratory tests—heating plant standby mode energy use, space heating steady-state efficiency, AH capacity, and full system output capacity—were used to optimize combi system efficiency. Data loggers were used with water flow rate and water temperature differences to measure system energy output. Gas meters and electric watt transducers were used to measure energy and power input at 1-s intervals. The data were then analyzed to determine the best operating parameters and system components. Hydronic AH steady-state performance measurements determined output capacities that provided acceptable return water and supply air temperatures. Heating plant capacity results were used to develop algorithms to determine whether a system could meet DHW and space heating loads. Combined space heating and DHW load profiles were used to evaluate transient performance.

Results

Standby tests showed that some heating plants had much higher loss rates than others. Figure 1 shows idle energy consumption at a set point of 140°F. Heating plants with no hot water storage (Boiler 1, Boiler 3, and TWH 1) had no gas use; the gas use for the units with storage varied from 29 to 103 therms/yr. The standby consumption of the three tank type WHs was about equal

to or lower than that of the tankless water heater (TWH 2) and boilers with storage (Boiler 2 and Boiler 4). TWH 2, Boiler 2, and Boiler 4 had standby losses greater than desirable considering those units had notably smaller storage volumes than the tank type heaters. For these systems, the level of insulation appeared to have more effect than the storage size on idle losses.

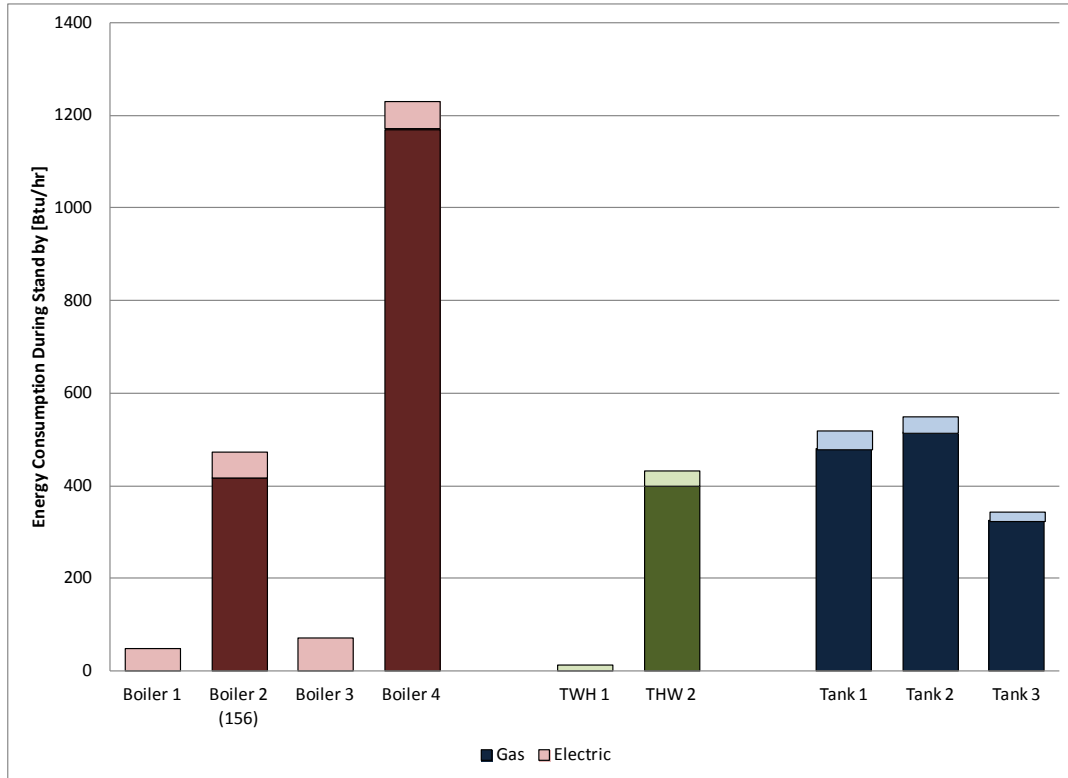

Figure 1. Energy consumption during standby mode operation at a set point of 140°F, except Boiler 2, which has a fixed internal hot water set point of 156°F

Figure 2 shows the steady-state efficiency of each heating plant for a range of return water temperatures, 90°–120°F, which resulted in heating load of 20,000 to 100,000 Btu/h. (A set point temperature of 130°F and a flow rate of 4 gpm were used for all tests.) The heating plants had similar steady-state efficiencies with a low of 86.1% for Boiler 3 and high of 90.6% for TWH 2. Given that the uncertainty of the efficiencies was 1.5 percentage points, the difference in steady-state efficiency was significant only for the highest and lowest efficiency systems. The average efficiency of the four boilers was 1.8 percentage points lower than the average for the TWHs and 1.9 percentage points lower than the average for the tank type WH average. However, the difference in average efficiency between the three system types was within the expected measurement error.

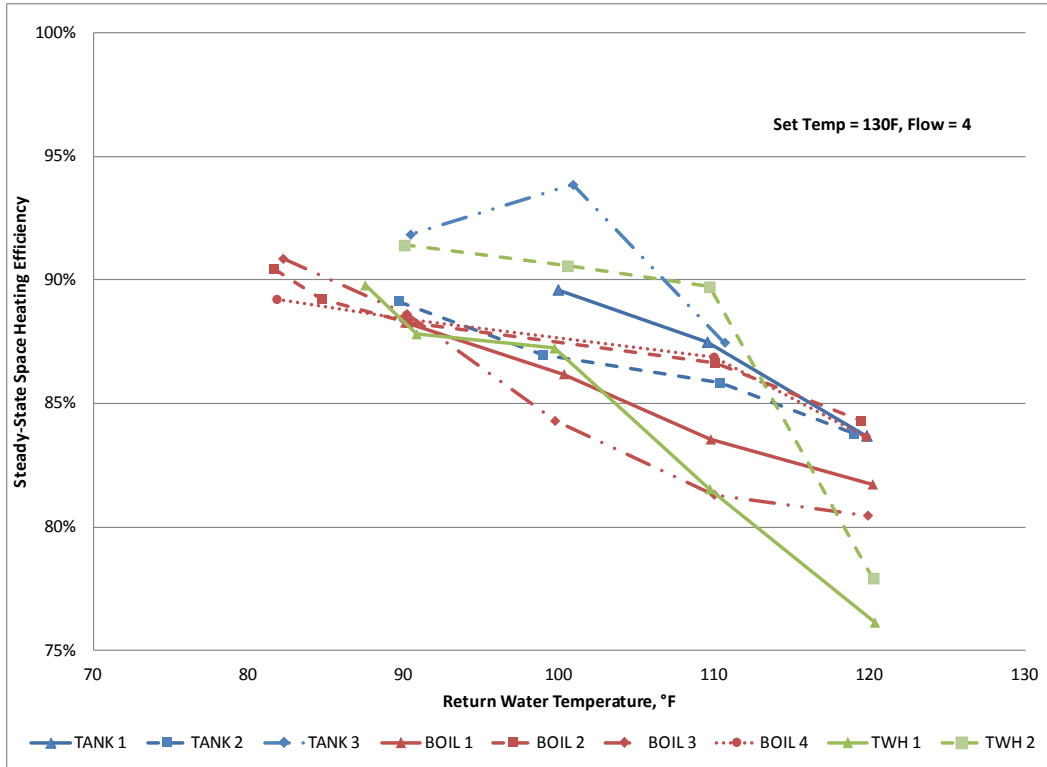

Figure 2. Heating plant steady-state space heating efficiency over a range of return water temperatures

AH capacity testing determined the available heat output rate for each AH. AH capacity was determined by requiring the water temperature leaving the AH to be $\leq 105^{\circ}\text{F}$. The delivered air temperature was required to be $\geq 110^{\circ}\text{F}$ to prevent occupant discomfort. These requirements greatly restricted the available capacities from those specified by the manufacturers.

Conclusions

The highest system efficiencies were achieved by minimizing the water temperatures returning from the hydronic AH. Heating loads were determined for each site. These loads were used to select the water flow rates and airflow rates that would result in low return water temperatures and meet the necessary load with an acceptable air temperature. Laboratory tests showed that the heating plant steady-state efficiency decreased with increasing return water temperature. The decrease in efficiency became more significant as the return temperature increased above 110°F .

Laboratory testing verified that systems were capable of meeting heating loads up to 50,000 Btu/h with acceptable return water temperatures and supply air temperatures. These designs provide steady-state space heating efficiencies $>85\%$.

System design and sizing information developed in the laboratory is currently being used to optimize systems for the 300 site implementation project. The laboratory work has been invaluable to this process. The installers and program managers thus have confidence that these systems will meet the needs of the homeowners.

The performance of combi systems is limited by currently available equipment. Most hydronic AHs were not designed to produce lower return water temperatures necessary for combi systems with a condensing heating plant. Several manufacturers, at least one in direct reaction to the findings from this project, have begun to improve combi equipment. AHs with improved heat transfer performance will allow for lower and lower return water temperatures. Variable flow rate water pumps and fans, along with the necessary control capabilities, have significant potential to provide a greater range in heating output and to provide low return water temperatures. Also, the manufacturer required that the primary secondary loop configuration for combi systems using boilers significantly increases return water temperatures, reducing system efficiency. Modifications to this configuration could improve system efficiency as much as 10%.

1 Introduction

Better insulation and tighter envelopes are reducing space heating loads for new and existing homes. For many homes, decreased space heating loads enable a single heating plant to provide space and domestic water heating loads. These systems, called dual integrated appliances or combination (combi) systems, can also eliminate safety issues associated with natural draft appliances because they use one common sealed combustion vent. Figure 3 shows a typical combi system set up, with a heating plant and a hydronic air handler (AH). During a hot water draw the heating plant operates like a water heater (WH): cold water comes into the storage volume as hot water leaves (for units with storage). In systems without storage, cold water enters and is heated as necessary. During a space heating event, hot water leaves the heating plant, passes through the coil in the AH, and transfers heat into the airflow. The cooler water then leaves the AH and flows back to the heating plant. The figure shows an open loop system where potable water is circulated to the AH for space heating. Closed loop systems use a heat exchanger between the heating loop in the heating plant and the AH.

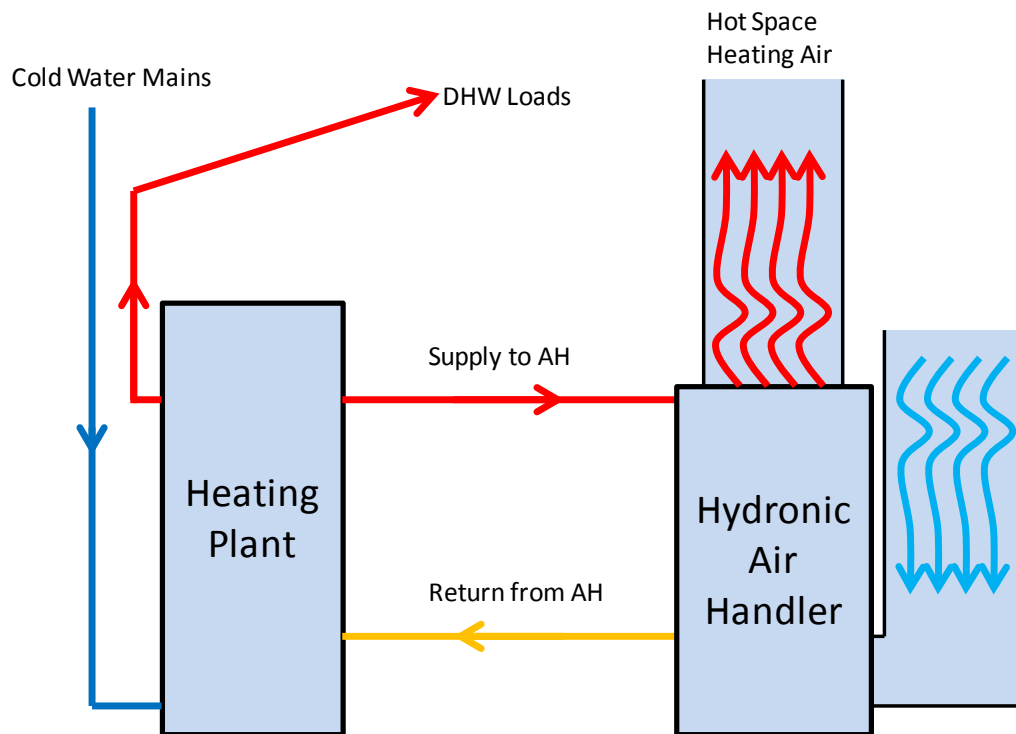

Figure 3. Diagram of a combined space and water heating system

The research will use combi systems with condensing WH or boiler heating plants teamed with forced air distribution space heating systems. In each house, the furnace will be replaced with a hydronic AH that includes an AH, water coil, and water pump to circulate water between the heating plant and the coil. The tank type WH will be replaced by either a WH or a boiler with a separate circuit for domestic hot water (DHW). Various options for DHW priority, DHW tempering, and heating plant temperature set-point control will be considered.

This project will use several types of condensing heating plants to characterize the installed performance of combi systems. The primary objective will be to document energy savings, and

the monitoring will include key system parameters such as return water temperature to better understand variations from expected performance and identify improved system designs. The project will also determine the installation costs and potential cost reductions with widespread implementation.

1.1 Background

Historically, mechanical contractors have custom engineered and pieced together combi systems in the field. They focused on assembling functional systems and had neither the time nor the means to evaluate or optimize the systems' energy efficiency. As high efficiency condensing WHs and boilers gain a larger share of the residential market, there is greater potential to use these systems to improve the efficiency of space heating and DHW loads.

Research is needed to address several outstanding questions about combi systems, such as:

- What is the actual installed energy savings of an optimized combi system with a condensing heating plant?
- What are the installation costs and paybacks of these systems?
- Can contractor familiarity and experience with combi systems reduce installation prices?

The concept of a single heating plant to supply space and water heating has been around for many years. Bohac et al. (1995) installed and monitored combis in small commercial and multifamily buildings in 1990. These systems used a natural draft storage WH to generate heat. The 1.5 years of monitored operation demonstrated that these systems could be reliably installed, perform without failure, and save energy. The combi systems in this project had annual fuel utilization efficiency (AFUE) ratings of at least 78% and replaced natural draft WHs with efficiencies in the 50% range and furnaces with AFUEs around 60%. The study found that these systems saved an average of 24% in energy use annually.

Noncondensing natural draft WHs were used in earlier combi systems. Condensing heating plants substantially increase the energy savings potential of combi systems. Laboratory testing (Thomas 2010) demonstrated that when combi systems replace mechanical equipment in modern homes, they must use condensing heating plants to achieve similar or improved energy performance.

Combi systems using high efficiency heating plants are relatively new. Several laboratory test and field installations identified potential problems. Laboratory tests by Brookhaven National Laboratory (Butcher 2011) showed that the manufacturer-specified plumbing configuration with a primary and secondary loop made it difficult to achieve the high efficiency potential of condensing combi boilers. A field installation by the New York State Energy Research and Development Authority (Rudd 2010) examined durability issues for systems using tankless water heaters (TWHs). The study assessed problems with hard water, scaling, and short cycling. Water residues accumulated on the TWH inlet filter and eventually prevented the heater from activating. The study installed an industrial strainer on the inlet water line, which prevented WH failure and reduced the maintenance interval to an annual filter change.

A large sample field study will help determine how these systems work in the real world, and will assess the actual installed efficiency and performance of combi systems. These field tests will use current high efficiency products tested and optimized in the laboratory to determine the actual energy savings of well-designed combi systems. This report provides results from the laboratory tests; a later report will cover results from the field study.

1.2 Relevance to Building America's Goals

Combi systems have potential to significantly reduce home energy use. An optimized combi system can provide space and water heating with a 95% efficient heating plant, compared to a minimum efficiency 78% AFUE furnace and a 0.59¹ energy factor (EF) WH. These metrics cannot be compared directly; detailed laboratory and field monitoring is necessary to determine actual savings. The large difference between the efficiency numbers shows the potential for savings. Removing a naturally drafted WH also allows the home to be more airtight without causing combustion safety issues, and can eliminate combustion makeup air. These two measures can further improve the energy performance of a home.

Combi systems are feasible in most climate regions. In colder climates the application may not be possible in larger homes with poorly insulated and leaky envelopes. Currently available equipment should target homes with space heating loads smaller than 60,000 Btu/h.

The implementation phase of this project will install 300 combi systems in Minnesota homes. At completion, the contractors should be ready to install the systems across the state. This project will also develop installation guidelines and specifications to increase the success of installation decisions in all climates.

1.3 Cost Effectiveness

The installed cost of a high efficiency combi system may be lower than that of a similar efficiency separate furnace and WH. In a retrofit application, a homeowner can expect to pay approximately \$4,000 for a high efficiency (90%–95% AFUE) furnace and \$4,000 for a high efficiency (0.80–0.95 EF) WH.² In the Minneapolis area, contractors with limited experience with combi systems currently bid a high efficiency system for \$6,000–\$9,000. A large number of installations are expected to reduce costs, much as the cost of high efficiency water heaters decreased as installations increased over the past few years.

A preliminary EnergyPlus analysis of a high efficiency boiler used for space and DHW heating estimated that natural gas use would be reduced by 12% and source energy by 7% compared to an 80% AFUE furnace and 0.55 EF WH. However, EnergyPlus is not easily adapted and may not properly model high efficiency combi system performance. EnergyPlus currently does not have models for performance of heating plants or combi systems. For example, it does not provide information on variations of efficiency with return water temperature. The test laboratory measurements for individual combi components are expected to provide performance data necessary for improved EnergyPlus models. Development of EnergyPlus combi system models will be completed in cooperation with National Renewable Energy Laboratory staff, with

¹ For a gas-fired water heater with a storage volume of 40 gal.

² High efficiency furnace and water heater numbers were determined through discussions with local installers.

the ultimate goal of incorporating combi system models into Building Energy Optimization (BEopt™) software.

1.4 Tradeoffs and Other Benefits

The combi system provides several secondary benefits. It replaces a separate furnace and WH with a single boiler or WH. This reduces the number of gas lines and exhaust vents from two to one, and a wall-mounted heating plant may reduce the equipment footprint. A combi system can allow for a more versatile mechanical room. In new construction, this may allow the mechanical equipment to be placed closer to the end uses, reducing delivery losses and hot water wait times.

A single high efficiency burner also has combustion safety and venting benefits. The high efficiency combi heating plants have power vent or direct vent exhaust systems. These eliminate combustion safety issues that arise as homes become better insulated and tighter with unbalanced ventilation. Sealed combustion burners may provide an additional energy benefit by eliminating combustion makeup air openings and possibly sealing a common chimney vent.

The single heating plant system also presents tradeoffs. The installation becomes more complex, which often requires onsite engineering and optimization to achieve maximum performance. Also, many contractors are unfamiliar with these systems.

The implementation phase of the project was designed to ensure that the installed combi systems include a warranty and expected durability at least equal to the alternatives. Combi systems also have a single heating appliance that is expected to require less annual maintenance than a separate furnace and WH.

As part of the test laboratory phase of the project, properly installed combi systems have been demonstrated to code officials and contractors who are bidding on the 300 field installations. The demonstrations allowed code officials to identify potential code concerns, such as water stagnation in potable rated AHs, and recommend acceptable solutions. Codes officials are thus more willing to accept this newer technology, and issues requiring attention during the installation and inspection process have been reduced.

1.5 The Role of Combi Systems in Low Income Weatherization

Advances in insulation, air sealing, and mechanical equipment have enabled low income weatherization to reduce heating loads and significantly improve home performance in Minnesota. As home airtightness has been reduced and exhaust ventilation is installed, there has been a greater concern with combustion gas spillage of natural draft WHs and other appliances. In many homes, weatherization agencies have been forced to spend about \$1,500 from a health and safety budget to install a power vented WH typically with an EF of 0.60 and only a small energy improvement. A combi system with a condensing boiler or WH eliminates the combustion spillage issue and provides higher efficiency DHW.

2 Experiment

Initial bids indicated that local mechanical contractors had only limited experience in the design and installation of high efficiency combi systems. The NorthernSTAR combi laboratory was created to identify proper system components, designs, operating parameters, and installation procedures to ensure high efficiency of field installed systems. The laboratory also provided a place for contractors, utility representatives, weatherization agents, and codes officials to see the systems and become familiar with their installation.

2.1 Research Questions

The laboratory tests address the following research questions:

- What equipment and design characteristics affect system performance and how can systems be optimized?
- What are the maximum and minimum heating loads that a combi system can meet efficiently and effectively?
- What are the minimum performance criteria, installation specifications and quality control methods that must be achieved to ensure proper performance and expected efficiency? What trouble areas of the installation can be addressed through these criteria and quality control methods?
- How can these systems benefit from improved combi products (boilers, WHs, hydronic AHs, pumps, controls, etc.)?

2.2 Technical Approach

This project designed and optimized combi systems for a large-scale implementation project. The Sustainable Resource Center, a low income weatherization provider in Minnesota, received a Sustainable Energy Resources for Consumers grant to install 300 combined space and water heating systems in homes participating in the State of Minnesota Low-Income Weatherization Assistance Program. The grant includes a monthly utility bill analysis of pre- and post-installation analysis of all 300 homes and of daily average space and DHW heating energy use for 20 of the homes.

Laboratory tests were conducted on a variety of complete combi systems and individual components before field installations started. Hydronic AH steady-state performance measurements determined output capacities that provided acceptable return water and supply air temperatures. Heating plant capacity results were used to develop algorithms to determine whether a system could meet DHW and space heating loads. Multiple systems were configured in the laboratory and experienced contractors reviewed initial designs to provide recommendations to improve performance, reliability, ease of installation, and cost. Twenty of the field systems will be extensively monitored to characterize their performance under real load conditions. The monitoring will determine overall system efficiency and the effects of many operational variables.

2.3 Measurements

The laboratory testing phase of the project documented the performance of currently available components and developed recommendations for optimized combi system designs. This required a series of tests on the heating plants, hydronic AHs, and fully assembled systems:

- Heating plant
 - Idle period energy use
 - Steady-state space heating efficiency for varying return water temperature
 - DHW transient supply water temperature
- Hydronic AH
 - Steady-state heat output for varying water and air flow rates
- Full system
 - Maximum capacity
 - Cyclic tests.

The idle tests were conducted by recording gas and electricity consumption when the heating plant had no DHW use or space heating load. The duration of the test included at least five burners on and recovery periods. All heating plants were tested at the same temperature set point and ambient conditions. Measured data were used for quantitative analysis of idle performance; infrared thermography was used to help identify sections of the heating plant with significant heat loss.

The heating plant steady-state space heating efficiency tests were conducted using a “work horse” heating plant to supply hot water at a set flow rate and temperature to simulate the water conditions returning from a hydronic AH (see Figure 4). System efficiencies were computed by measuring the energy into the heating plant, in natural gas and electricity, and the energy output in hot water. Measurements were conducted for return water temperatures of 80°–120°F to characterize the efficiency degradation with higher return temperatures. This determined an optimized water circulation flow rate and heat output sizing of the hydronic AH. Laboratory tests were used to analyze the transient performance of the combi systems. These tests were not used to determine annual combi system efficiencies, but to examine delivery capabilities. Water temperatures were tracked during a sudden increase in DHW flow to determine hot water delivery times. The tests also examined transient supply water temperature under three simulated conditions: (1) a space heating event is interrupted by a DHW event (e.g., a shower); (2) a shower is interrupted by a second shower; and (3) a shower is interrupted by a space heating event.

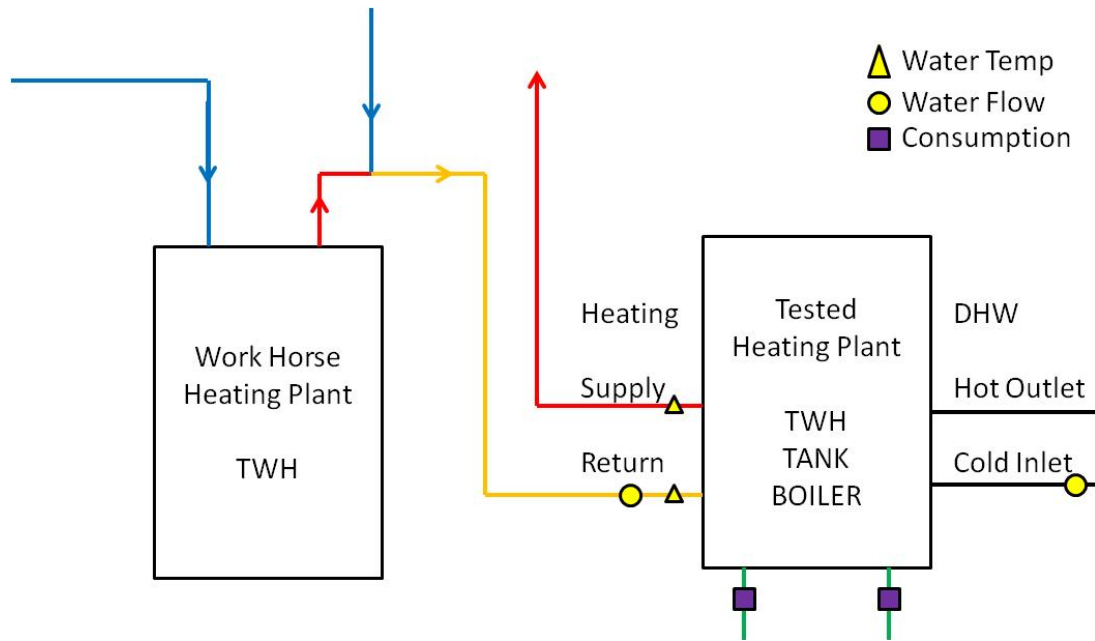

Figure 4. Test setup for the heating plant with a simulated AH

The hydronic AH tests characterized the performance of units in conditions within and outside the range of manufacturer specifications. Manufacturers often do not specify performance for the lower water circulation flow rates necessary for optimized heating plant efficiency. The tests measured the heat output rate, supply air temperature, return water temperature, and electricity consumption for controlled variations in airflow rate, water flow rate, water supply temperature, and air inlet temperature (see Figure 5). Space heating output capacity was computed from the water flow rate of the space heating loop and the temperature drop over the AH. Air temperatures were measured with thermocouples: a three thermocouple array on the supply side and a single probe in the return duct. Airflow rates were measured with a TrueFlow AH flow meter in the return duct (Energy Conservatory 2008). Air temperatures entering the AH were used to verify consistent conditions in the laboratory. Supply air temperatures were used to determine whether the delivered air would provide acceptable occupant comfort, but were not used for the energy output analysis. This methodology uses air temperature and flow rates only to determine occupant comfort, which did not require measurements to be highly accurate. Air temperatures were measured with thermocouples with $\pm 1^\circ\text{F}$ accuracy compared to the water temperature measurements that were made with $\pm 0.1^\circ\text{F}$ accuracy.

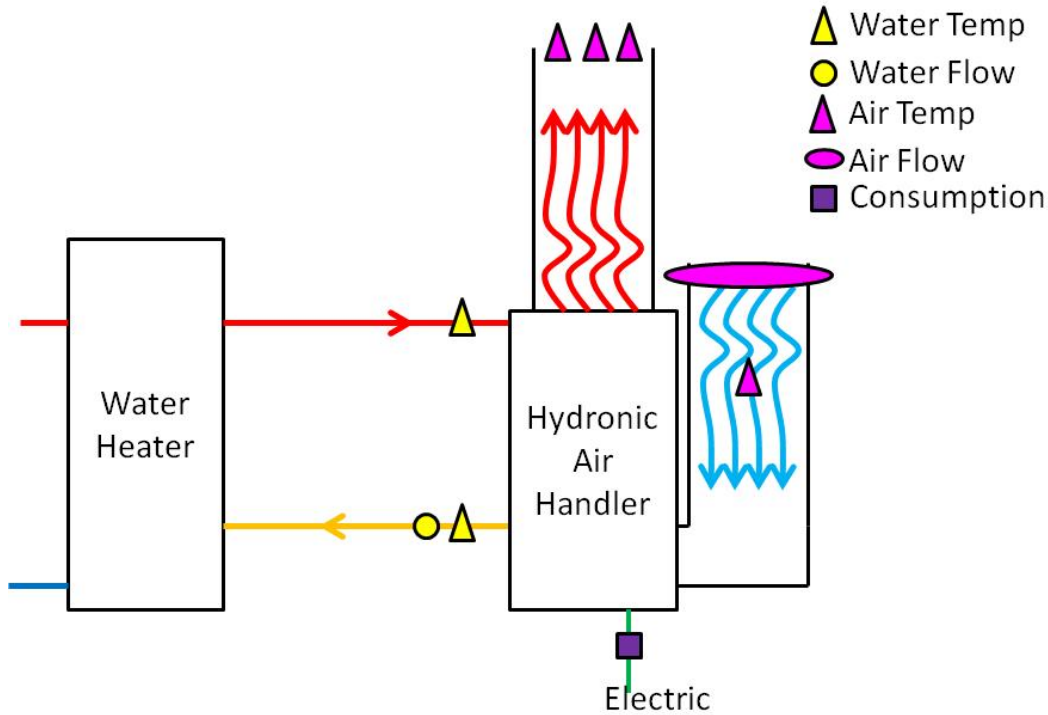

Figure 5. Test setup for the AH testing

Combi systems were operated using several hourly load patterns to determine cyclical performance and maximum capacity. Several DHW and space heating load profiles were developed to evaluate the warmup and post purge portions of the heating plant firing cycle. Additionally, the tests required the combi system to simultaneously supply heat for two showers and a space heat cycle. The load profiles for these tests are included in the results section.

2.4 Combi Equipment and Test Instrumentation

The test laboratory was equipped with a comprehensive and accurate monitoring system utilizing high-precision instruments (see Table 1). A Campbell Scientific model CR-3000 data logger was programmed to measure instrument outputs and record processed data at specified intervals. A propagation of errors method using the uncertainties of individual instruments for typical operating conditions computed an uncertainty of 2% for the calculated hot water energy output and an uncertainty of 2.5% for the system efficiency. Three identical sets of monitoring systems were used for tests on nine heating plants and five AHs (see Table 2 and Table 3). Figure 6 includes photos of some of the systems installed in the laboratory. All equipment was installed to meet manufacturer's specifications. Heating plant vents were run as two pipe systems meeting in a concentric termination kit at the roof. One unit required concentric venting for the full vent run. Vent lengths were about 30 ft, well within the specifications for all manufacturers.

Table 1. Laboratory Instrumentation

Measurement	Sensor Type	Resolution	Precision	Range
Water Volume Flow Rate	Nutating disk flow meter	198.4 pulses/gal	2% of reading	0.5–25 gpm*
Natural Gas Volume	Diaphragm meter, with pulse output	40 pulses/ft ³	0.3% of reading	0–250 cfm
Water Temperatures	Matched pair of immersion resistance temperature detectors	0.002°F @140°F	1/10 DIN: 0.03°F @32°F	–148° to 752°F
Electric Energy	Watt transducer	0.02 W	0.2% of reading	0–1000 W
Air Temperature	Thermocouple array	0.03°F @140°F	Greater of 1.8°F and 0.75% of reading	–454° to 725°F

*The meter measures flow rates <0.5 gpm, but the precision decreases for flow rates outside the specified range.

Table 2. Laboratory Tested Combi Heating Plants

Equipment ID	Equipment Type	Manufacturer	Model	Input (kBtu/h)	Storage (gal)
BOIL 1	Condensing boiler	Rinnai	E75C	17–75	0
BOIL 2	Condensing boiler	Rinnai	Q175C	35–175	7
BOIL 3	Condensing boiler	Navien	Combi Boiler	20–175	0
BOIL 4	Condensing boiler	Triangle Tube	Prestige	30–110	12
TWH 1	Condensing TWH	Rinnai	98Lsi	9.5–199	0
TWH 2	Hybrid condensing TWH	Grand Hall	Eternal	31–199	2
TANK 1	Condensing storage WH	A.O. Smith	Vertex	100	50
TANK 2	Condensing storage WH	HTP	Phoenix	35–100	55
TANK 3	Condensing storage WH	American	Polaris	100	34

Table 3. Laboratory Tested Hydronic AHs

Equipment ID	Equipment Type	Manufacturer	Model
AH 1	Hydronic AH	Rinnai	37AHB060
AH 2	Hydronic AH	Rinnai	37AHB075
AH 3	Hydronic AH	ADP	BVR00031s4p3
AH 4	Hydronic AH	Nu-Air	en7030i
AH 5	Hydronic AH	Enerzone	xah70vs-x13-pt-4row
AH 6	Hydronic AH	First Company	8VMR
AH 7	Hydronic AH with heat recovery ventilator	Lifebreath	CFA-U-S4A-24-E16
AH 8	Hydronic AH with heat recovery ventilator	NuAir	EN712E
AH 9	Nonpotable hydronic AH	Lennox	cbwmv-36c-090-1

Table 2 lists the nine heating plants installed in the laboratory. Of these, four were classified as boilers, three as tank type WHs and two as TWHs. Each of the boilers was a combi boiler with both space heating and domestic water heating loops. Two (Boiler 1 and Boiler 3) were low mass boilers and contained no internal storage. TWH 1 was a traditional condensing; TWH 2 was a hybrid between a TWH and a storage WH. This unit had a large burner (199,000 Btu/h at full capacity) and a small (2-gal) storage tank.



Figure 6. Photos of test laboratory with combi system installations and venting terminations

3 Analysis

3.1 Standby Loss and Steady-State Efficiency Analysis

The laboratory heating plant, hydronic AH, and full system test procedures are described in Section 2.3. The heating plant idle energy use was computed from the average rate of natural gas and electricity use when the system went through four to five burner cycles necessary to keep the unit at the operating set point. Enough cycles were tested so only small variances in energy consumption occurred between cycles, which ensured consistent idle performance and equal embodied tank energy at the start of each cycle. The energy use was summed from the start of the first burner cycle to just before the start of the final cycle and divided by the elapsed time to compute the average rate of energy use. Starting and ending the monitoring period just prior to the burner on time helped reduce the difference in the energy stored in the plant from the start to the finish of the monitoring period. The natural gas energy use was computed from the natural gas volumetric flow rate measured by a diaphragm flow meter multiplied by the heat factor (see equation 1). A watt transducer directly measured the electricity use.

To simulate the water conditions returning from a hydronic AH, the heating plant steady-state efficiency test was conducted using return water supplied at a steady temperature and flow rate. The energy output rate was calculated from the water flow rate and temperature difference as shown by equation (2). A third physical plant test evaluated the transient performance of hot water delivery under three simulated conditions. The transient performance was quantified by determining the length of time required for the temperature to rise to within a specified difference from the set point or the maximum deviation from set point when a second load was placed on the unit (e.g., a second shower starting while the first was in process). The measurement response time was minimized by using a resistance temperature detector in an emersion thermowell.

$$q_{in} = Q_g \cdot HF \tag{1}$$

$$q_{out} = C_p \cdot \rho \cdot Q_w \cdot 60 \cdot \Delta T \tag{2}$$

$$\eta = q_{out}/q_{in} \tag{3}$$

where:

- q_{in} = energy input, Btu/h
- q_{out} = energy output, Btu/h
- C_p = specific heat of water (varies by temperature), Btu/(lb*°F)
- ρ = water density at the flow meter (varies by temperature), lb/gal
- Q_w = water flow rate, gpm
- ΔT = temperature output difference, °F
- Q_g = burner natural gas flow rate, ft³/h
- HF = natural gas heat factor, Btu/ft³
- η = thermal efficiency

3.2 Air Handler Capacity Analysis

The hydronic AH tests characterized the performance of units in conditions within and outside the range of manufacturer specifications. Tests measured the energy output rate, supply air temperature, return water temperature, and electricity consumption for controlled variations in airflow rate, water flow rate, water supply temperature, and air inlet temperature. The energy output rate was computed from equation (2) using the water flow rate and temperature difference entering and leaving the hydronic coil.

3.3 Full System Analysis

Combi systems were run under several hourly load patterns to determine cyclical performance and maximum capacity. Several DHW and space heating load profiles were developed to evaluate the warmup and postpurge portions of the heating plant firing cycle. The tests required the combi system to simultaneously supply heat for the equivalent of two showers and a space heat cycle. Equations (1) and (2) were used to compute the system energy input and output. The total output was computed from the sum of the space heating (hydronic AH) and DHW energy outputs. For many of the load patterns,³ the system efficiency during cyclical operation was computed from equation (3). The space heating energy output rate was computed from the water flow rate and temperature difference entering and leaving the hydronic coil and the DHW energy output calculation used the DHW flow rate and temperature difference between the water entering and leaving the heater.

3.4 Error Analysis

Two types of error must be accounted for in the laboratory measurements: accuracy of the sensors and error introduced by sensor location. Instrumentation was installed according to the manufacturers' specifications such that additional error due to the installation was minimized or eliminated. Water temperature and flow sensors were installed with enough straight pipe length on the inlet and outlet of the sensor to maximize accuracy. Long straight ducts were not possible on the supply side of AHs. A three-sensor array was used to capture the temperature variance across the supply duct. Accurately measuring air temperatures was difficult. Water temperatures and flow rates in the heating loop were therefore used to calculate the output delivered in space heating mode and water flow rates and temperatures in the hot water loop were used to calculate the output in hot water mode. Air temperatures were used for occupant comfort in the optimization process where being within a couple of degrees is acceptable.

The laboratory testing and optimization were mostly concerned with parameters that were measured directly, such as water temperature, water flow rate, and air temperature. The error in these parameters can be taken directly from the instrumentations (see Table 1). The error was calculated for three parameters: energy input (Q_{in}), energy output (Q_{out}), and efficiency (η). Energy input had an error of 1.0%, accounting for the variation in the natural gas heating value and the error in the gas meter. Energy output had an error of 2.0% accounting for the error in the

³ The stored energy does not cause significant error in the efficiency estimate for patterns with higher loads. All test profiles were run from burner cut out to cut out, making the difference in tank temperatures small (assuming a 1°F temperature difference the stored energy change would be about 350 Btu). The effect of stored energy would be <1% for tests with an energy output >35,000 Btu.

water temperature difference, water flow rate, and the error in the estimation of the properties of water. Combining these errors gives the efficiency an error of 2.2%.

4 Results

Laboratory tests were conducted between March and September 2011. All tests were conducted with ambient laboratory temperatures and return air temperatures of 68°F.

4.1 Standby Loss

Idle mode operation natural gas and electricity consumption data were collected at multiple temperature settings for all nine heating plants. Table 4 and Figure 7 show idle energy consumption at a set point of 140°F. Idle tests were run through enough burner cycles for consistency and repeatability. The actual test lengths varied by heating plant. Plants with larger storage capacities, storage WHs, were run longer, up to a week if necessary. Heating plants with no hot water storage (Boiler 1, Boiler 3, and TWH 1) had no gas use; the gas use for the units with storage varied from 29 to 103 therms/yr. The standby consumption of the three tank type WHs was about equal to or lower than that of TWH 2 and boilers with storage (Boiler 2 and Boiler 4). TWH 2, Boiler 2, and Boiler 4 had standby losses greater than desirable considering those units had notably smaller storage volumes than the tank type WHs (see Table 4). For these systems, the level of insulation appeared to have a greater effect than the storage size on idle losses. Figure 8, Figure 9, and Figure 10 show thermal images of heating plants Boiler 4, TWH 2, and TWH 1, respectively. Boiler 4 had significant heat loss from the larger diameter, uninsulated pipes inside the unit. The images of TWH 2 indicate that most of its heat loss was off the top of the internal tank. TWH 1 did not have storage, and therefore had small heat loss in standby mode. Reducing the temperature set point from 140°F to 120°F reduced natural gas consumption by 25% for heating plants with storage.

Table 4. Standby Site Energy Consumption at a Set Point Temperature of 140°F

Heating Plant	Storage (gal)	Annual Gas Use		Annual Electricity Use		Total Annual Energy Use	
		(therms)	(\$)	(kBtu)	(\$)	(kBtu)	(\$)
Boiler 1	0	0	0	126.1	15	126	15
Boiler 2	6.6	36.6	37	141.0	17	3,796	53
Boiler 3	0	0	0	180.6	22	181	22
Boiler 4	14	102.5	103	153.4	18	10,408	121
TWH 1	0	0	0	34.4	4	34	4
TWH 2	2	35.1	35	80.6	10	3,593	45
Tank 1	50	42.0	42	104.7	13	4,306	55
Tank 2	55	45.1	45	89.7	11	4,600	56
Tank 3	34	28.5	28	50.8	6	2,897	35

Note: Assumed rates of \$1/therm and \$0.12/kWh

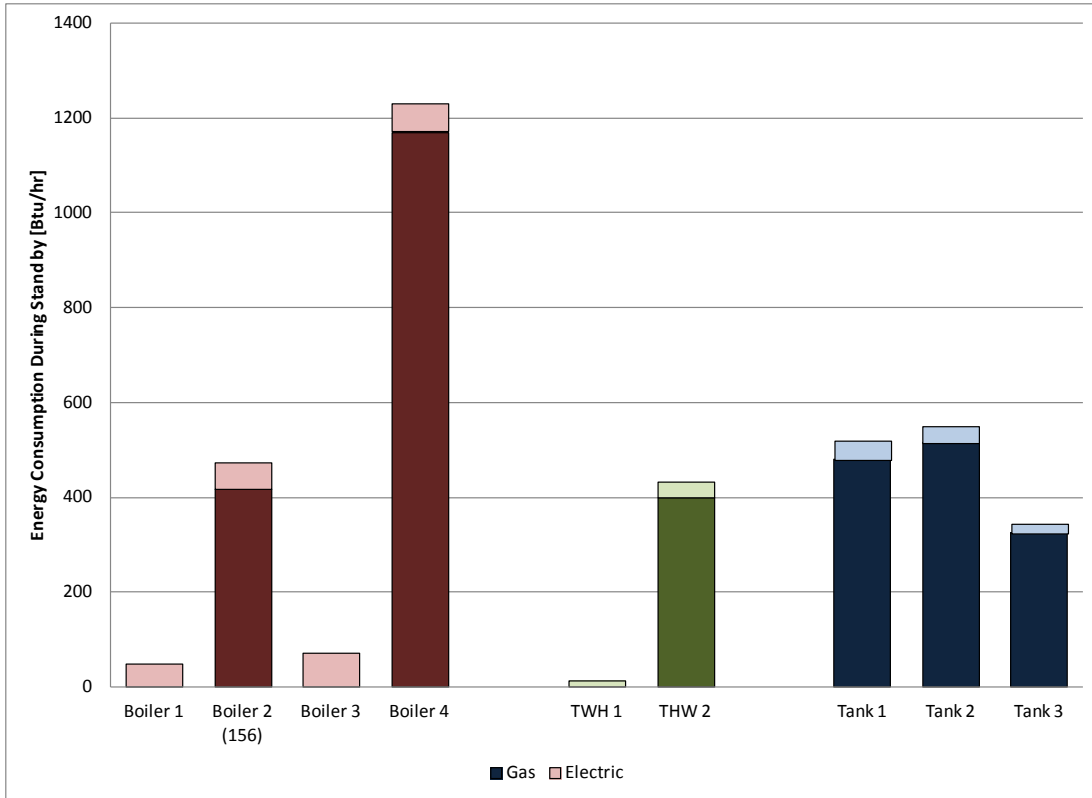

Figure 7. Energy consumption during standby mode at a set point of 140°F

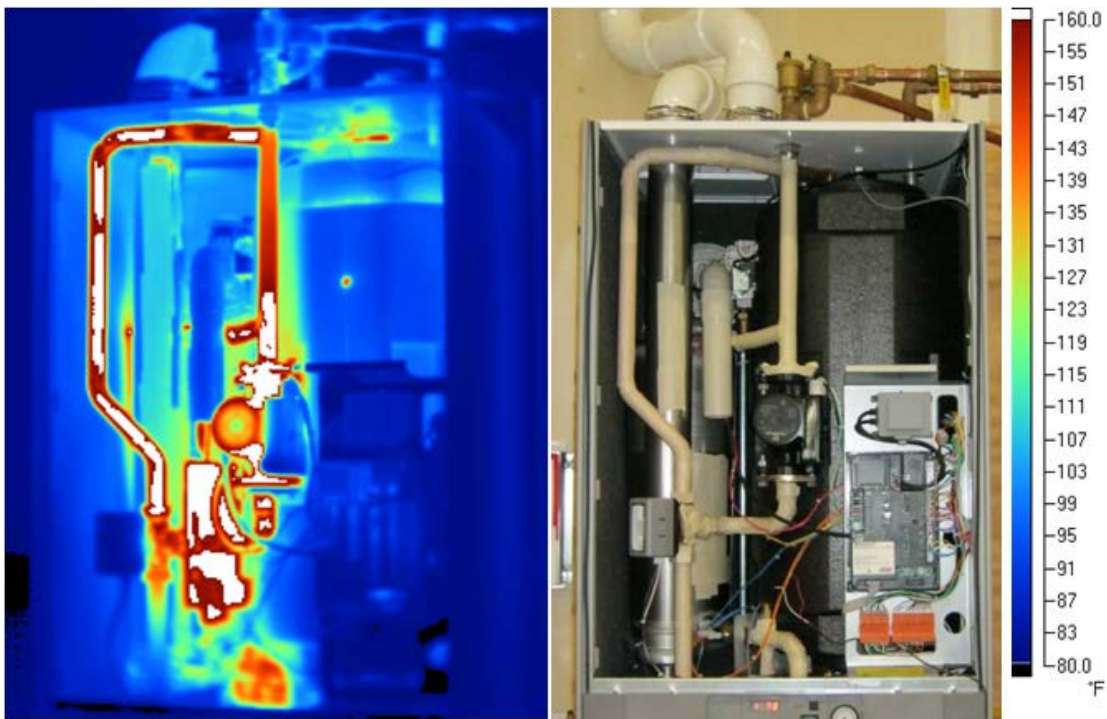

Figure 8. Infrared and visual images of Boiler 4 in standby operation

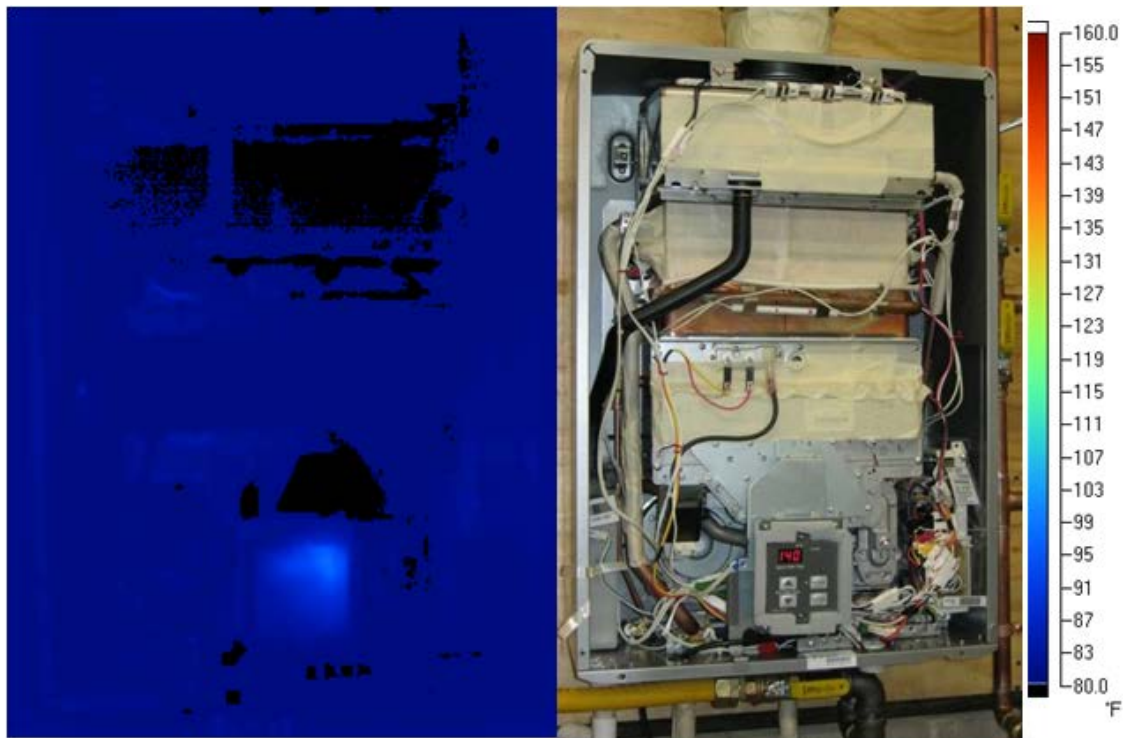

Figure 9. Infrared and visual images of TWH 1 in standby operation



Figure 10. Infrared and visual images of TWH 2 in standby operation

4.2 Steady-State Efficiency

Inlet water temperature significantly impacts the efficiency of a condensing heating plant. This relationship has been previously demonstrated for condensing boilers (Arena 2011). The heating plant requires low return water temperature to operate in condensing mode. A series of laboratory tests determined the efficiencies associated when the hydronic AH return water temperature varied from 80°F to 120°F. Figure 11 illustrates the decrease in steady-state efficiency with increasing return water temperature. The efficiency of several heating plants decreased when the return temperature increased above 110°F. This can be significant over the life of the heating system. Assuming an annual load of 100 million Btu (a typical space heating load in Minnesota) a 10% efficiency reduction represents an increased gas cost of about \$150/yr.

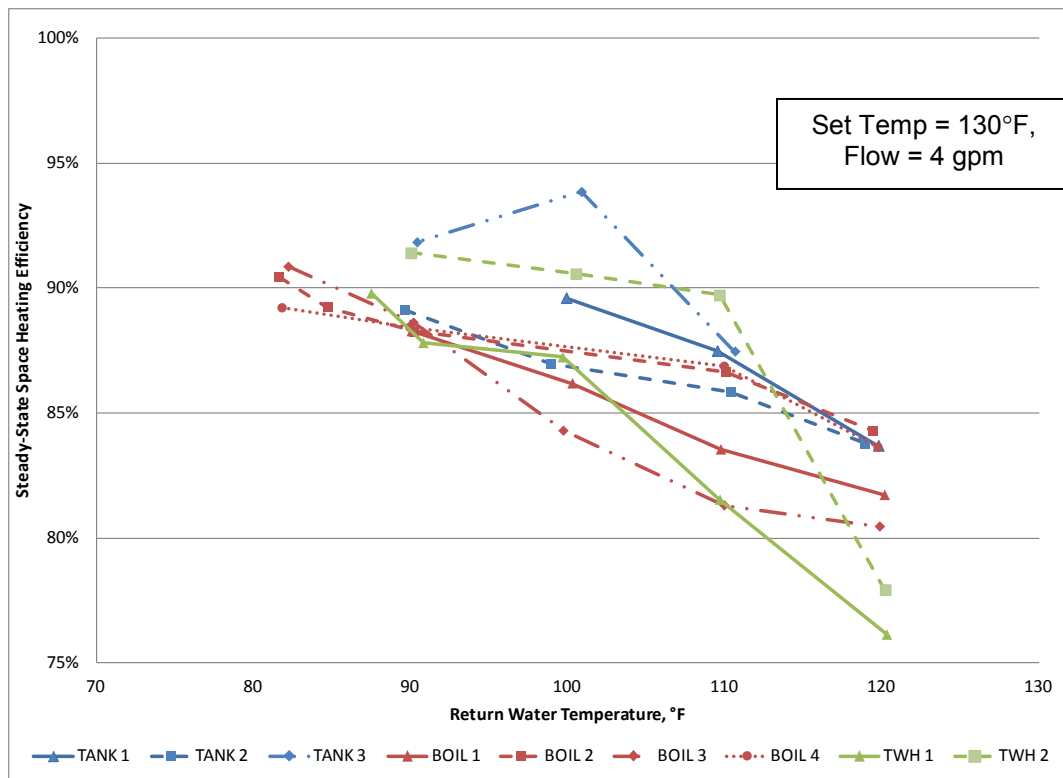

Figure 11. Heating plant steady-state efficiency over a range of return water temperatures

Figure 12 shows the steady-state efficiency⁴ of each heating plant for a range of return water temperatures (90°–120°F), which resulted in heating load of 20,000–100,000 Btu/h (a set point temperature of 130°F and a flow rate of 4 gpm were used for all tests). The heating plants had similar steady-state efficiencies with a low of 86.1% for Boiler 3 and high of 90.6% for TWH 2. Given that the uncertainty of the efficiencies was 1.5 percentage points (see error bars in Figure 12), the difference in steady-state efficiency was significant for the highest and lowest efficiency systems only. The average efficiency of the four boilers was 1.8 percentage points lower than the average for the TWHs and 1.9 percentage points lower than the tank type WH average. However,

⁴ Includes natural gas and electric energy input.

the difference in average efficiency between the three system types was within the expected measurement error.

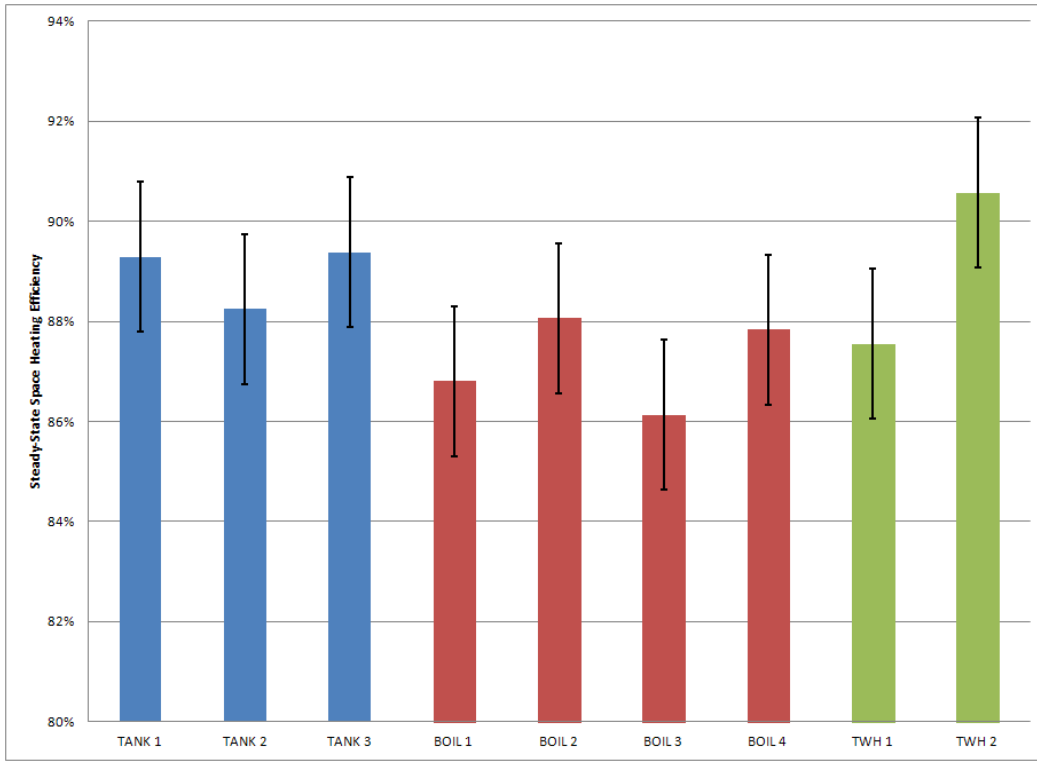

Figure 12. Heating plant steady-state efficiency for 60 kBtu/h heating load

Steady-state efficiencies discussed in this section were those of the heating plants only and include natural gas and electricity energy consumption. They do not include any electricity consumption that would be required by the AH to move the air.

Most heating plants tested used modulating burners, only TANK 1 and TANK 3 had single-stage burners (both at 100,000 Btu/h). Heating plants with modulating burners controlled their input rate to match the load. These burners reached a steady input and output rate. The steady performance was used for the test period. The two tanks with fixed burners cycled on and off to meet the load. Tanks were allowed to cycle until the total input and output of consecutive cycles were consistent.

All three tanks had maximum firing rates of 100,000 Btu/h and Boiler 1 had a maximum input rate of 75,000 Btu/h. These heating plants were unable to meet the 100,000 Btu/h load when return temperatures were reduced to 80°F.

4.3 Air Handler Capacity

Laboratory tests characterized AH performance and identified optimal space heating capacity ranges. The AH tests were configured to select the correct operational parameters for each AH. The first criterion was that the systems produce a minimum supply air temperature of 110°F for an entering air temperature of 69°F, ensuring acceptable occupant comfort for the air delivered from supply registers into the living spaces. The typical return air temperature in most Minnesota

homes was assumed to be 69°F; 110°F was the lowest delivered temperatures installers and program managers felt comfortable delivering to occupants. The minimum supply air temperature determined the lowest acceptable water flow rate for a given heating plant delivered water temperature and AH airflow rate. For example, Figure 13 shows that for AH7 the minimum allowable water flow rate was 2.2 gpm for an airflow rate of 1,050 cfm, 0.3 in. w.c. static pressure across the unit, and a supply water temperature of 140°F. All the AHs installed in the laboratory had multiple motor speeds that could be selected manually, but were not continuously variable. The number of available airflow speeds varied from unit to unit. None of the AHs installed in the laboratory had the ability to vary air speed in response to the heating load.⁵

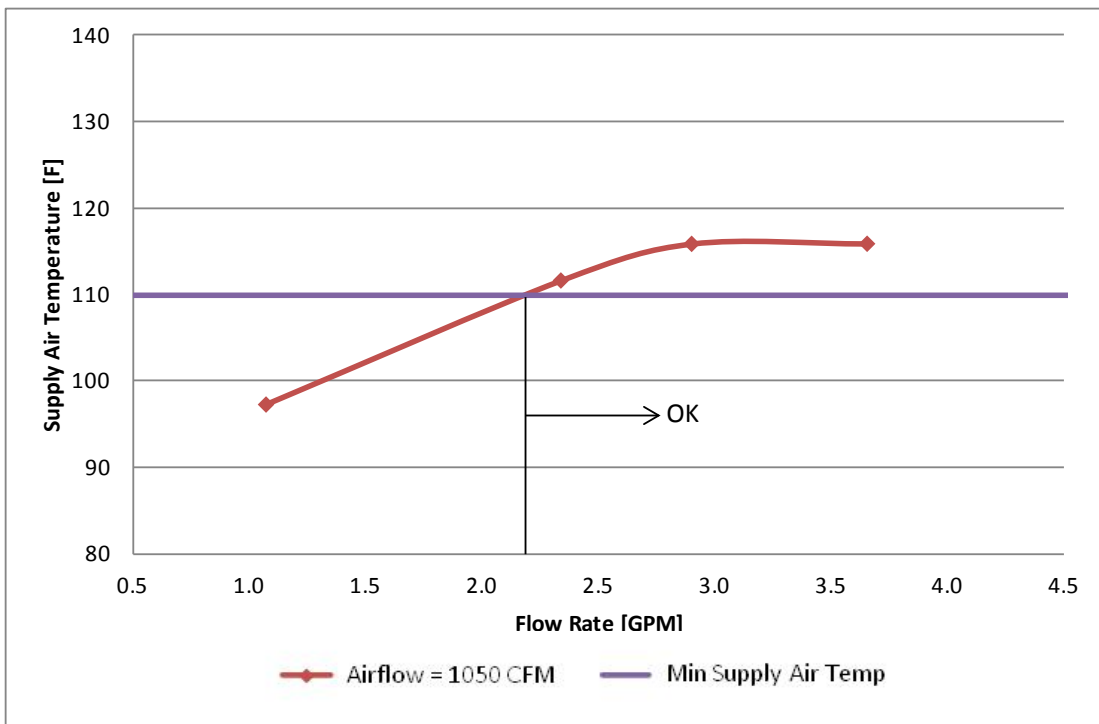

Figure 13. AH7 performance mapping test of supply air temperature

To achieve high heating plant efficiency, a maximum return water temperature of 105°F was used to find the largest allowable water flow rate for each AH at a given airflow rate and supplied water temperature. The maximum flow rate allowable for AH7 at 1050 cfm was 2.6 gpm (see Figure 14). The water flow rate range could be used with test data to determine the delivered capacity of each AH. AH7 had an optimized output capacity range of 45,000–50,000 Btu/h at 1050 cfm (see Figure 15). Table 5 shows the acceptable flow ranges for each AH for a heating plant temperature setting of 130°F and several airflow rates. Tests were performed over a wide range of water flow and airflow rates and temperatures. Tests were then normalized for specific airflows to compare multiple units. Several of the AHs were not able to achieve performance that would allow for high efficiency heating plant operation (see Table 5). At a given airflow rate, an AH may not have been able to produce air temperatures higher than 110°F

⁵ A unit that changes to a higher flow rate after 15 min of continuous operation was recently received and may be tested in the future.

and keep return water temperatures of 105°F. These tests were labeled not to have met performance parameters at that airflow. Some of the smaller AHs could not supply a large enough airflow to be tested at high flow rates. The equipment sizing process allowed an AH to be installed only if it was compatible with high efficiency heating plant performance for the home's load.

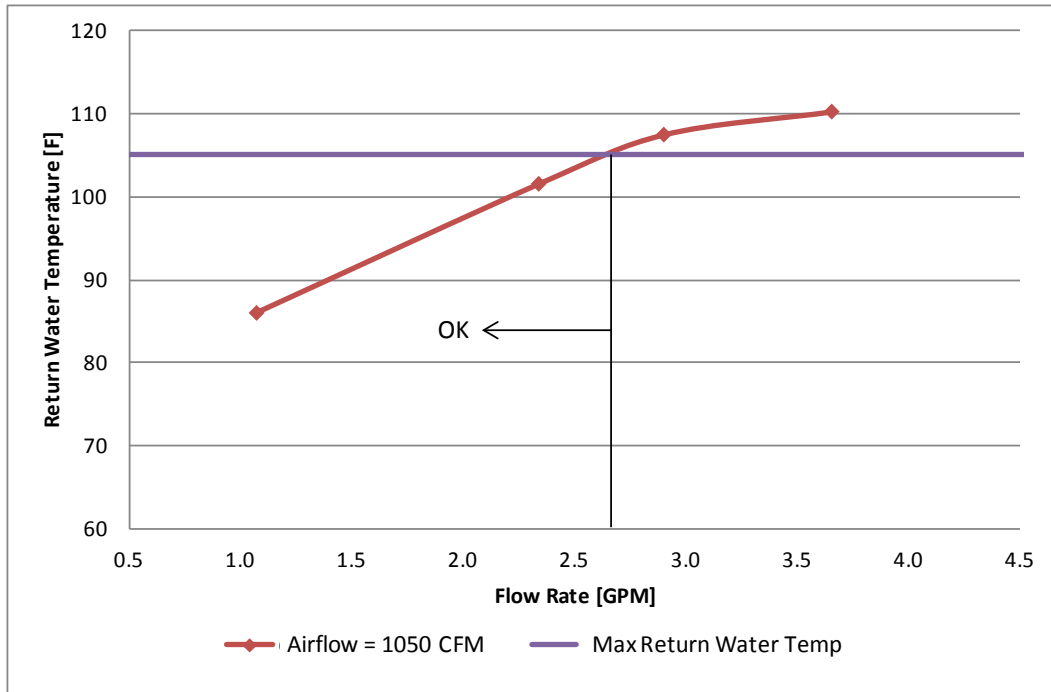

Figure 14. AH7 performance mapping test of return water temperature

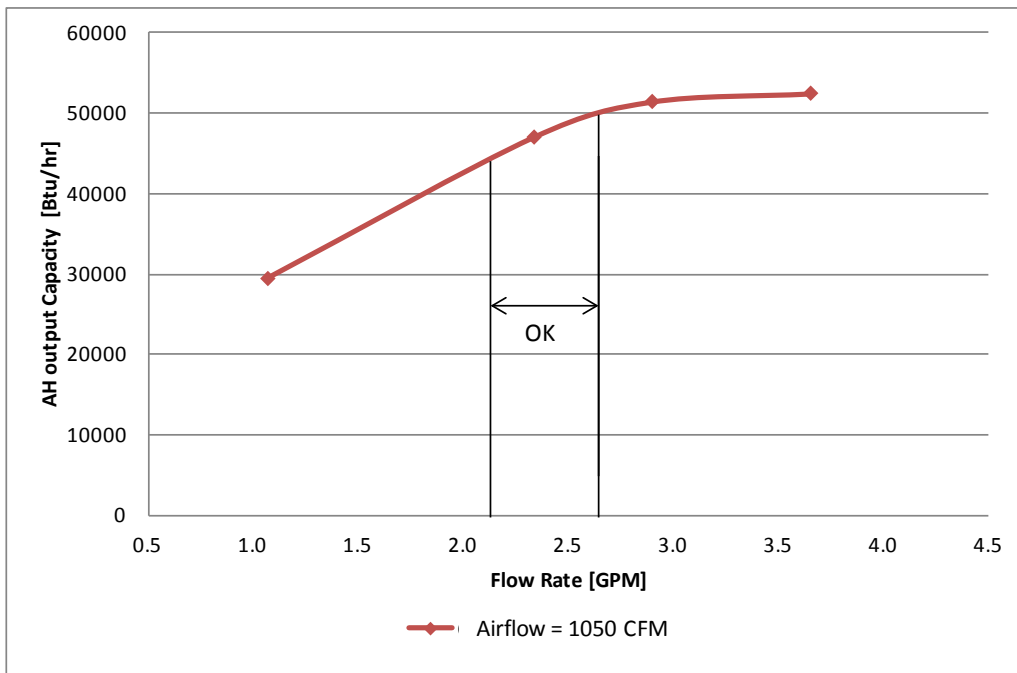

Figure 15. AH7 performance mapping test of space heating capacity

Table 5. Sizing Chart for AHs for a 140°F Supply Water Temperature

AH	Airflow Rate (cfm)	Water Flow Rate (gpm)		Heating Capacity (Btu/h)	
		Minimum	Maximum	Minimum	Maximum
First Airflow					
AH1	800	Never meets performance parameters			
AH2	800	Never meets performance parameters			
AH3	800	2.0	2.3	37,300	39,200
AH4	800	1.9	2.2	36,100	38,000
AH5	800	2.3	3.6	46,300	54,000
AH6	800	Never meets performance parameters			
AH7	800	Was not tested at this flow rate			
AH8	800	Never meets performance parameters			
AH9	800	2.0	2.1	34,300	35,900
Second Airflow					
AH1	1,100	Never meets performance parameters			
AH2	1,100	2.3	2.8	46,800	48,000
AH3	1,100	2.0	2.8	46,600	47,500
AH4	1,100	Never meets performance parameters			
AH5	1,100	2.0	3.2	53,000	56,300
AH6	1,100	Did not have enough airflow capacity			
AH7	1,100	2.0	2.9	48,700	50,200
AH8	1,100	Did not have enough airflow capacity			
AH9	1,100	Never meets performance parameters			

Note: Data from several tests were normalized to common airflow speeds.

It was important to develop these curves for each AH. Installing improperly sized AHs would have produced an uncomfortable supply air temperature or high return water temperature. For example, a return water temperature of 120°F reduces the steady-state efficiency to <85% for all the heating plants and to almost 75% for the TWHs (see Figure 11). This reduced efficiency would increase annual gas costs \$75–\$150 for a typical house.

Figure 16 shows the AH6 laboratory test and manufacturer specification data for a supply water temperature of 140°F and 800 cfm airflow rate. The figure shows that the laboratory-measured temperature drop across the coil was within 6% of the manufacturers’ specifications. For all tests, the laboratory-measured performance was typically within 10% of the manufacturers’ specifications. This indicates that the manufacturer’s specifications could be used to estimate equipment performance. However, these specifications provide data for only a limited range of operation. The AHs had fixed-speed pumps, so data were typically provided for only a single water flow rate, which was always higher than what was expected to be used for the installed system. Extrapolating performance based on specification data would have increased the uncertainty of the range of acceptable flow rates. The manufacturers’ specifications often did not include air temperatures for the rated performance.

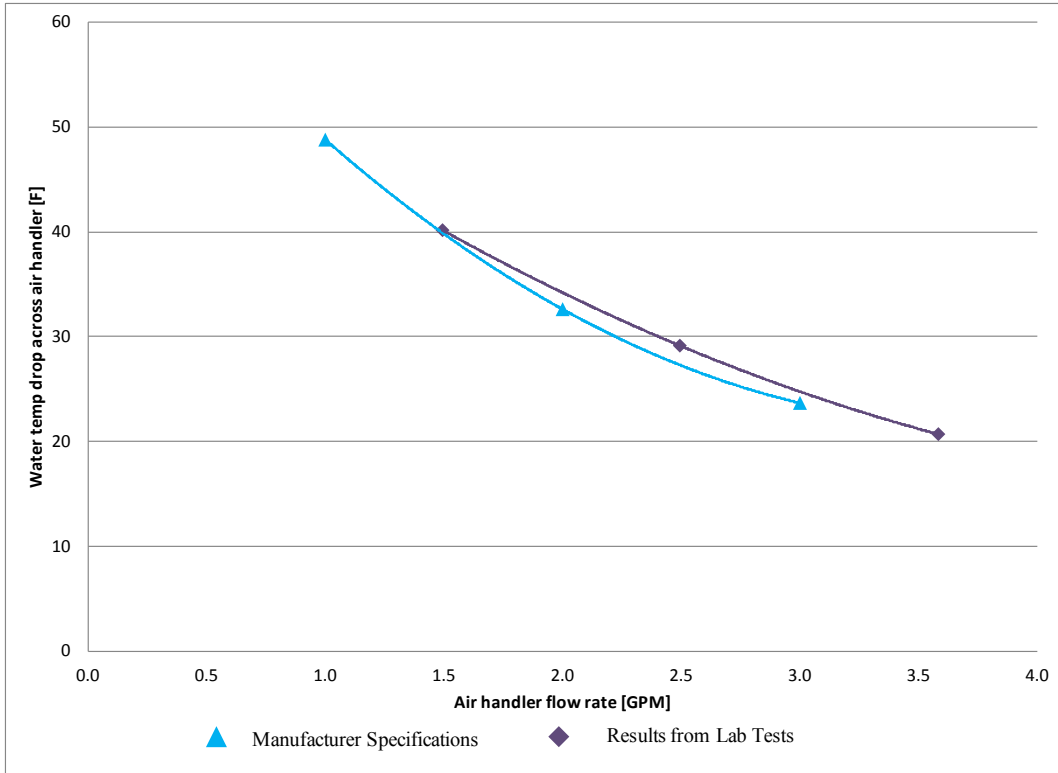

Figure 16. AH6 measured and manufacturer specified water temperature difference

4.4 Full System

Three DHW and space heating load profiles were developed for the full system tests to test a specific function of the combi system. Each was based on data collected from a previous WH field study (Schoenbauer et al. 2010). The “Maximum Capacity” profile consisted of two showers and a space heating demand running simultaneously to test the high load capability of each system (Figure 17). The “DHW Interrupt” profile (Figure 18) was designed to access the impact of DHW temperature when a heating call interrupts a DHW event. Figure 19 describes the “Low Use” load profile that tested the system’s ability to provide hot water for short DHW draws.

Table 6 lists the heating capacity and duration of the events in the full system tests.

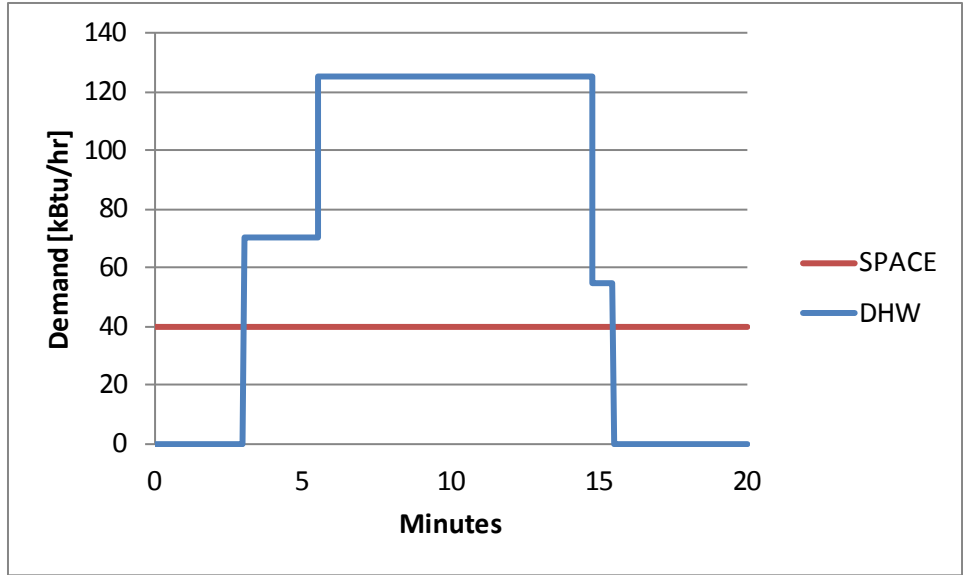

Figure 17. Maximum capacity test profile for full system tests

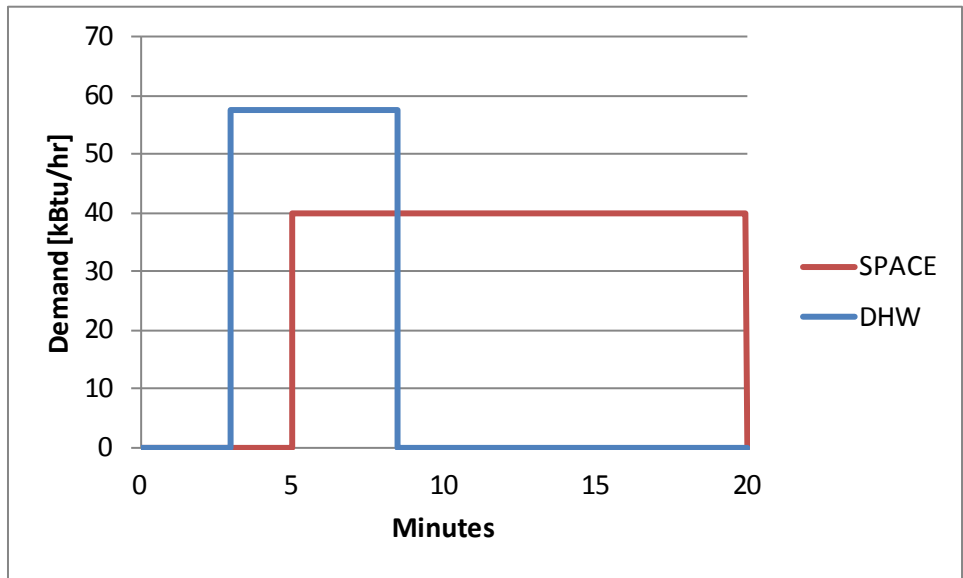

Figure 18. DHW interrupt load profile for full system tests

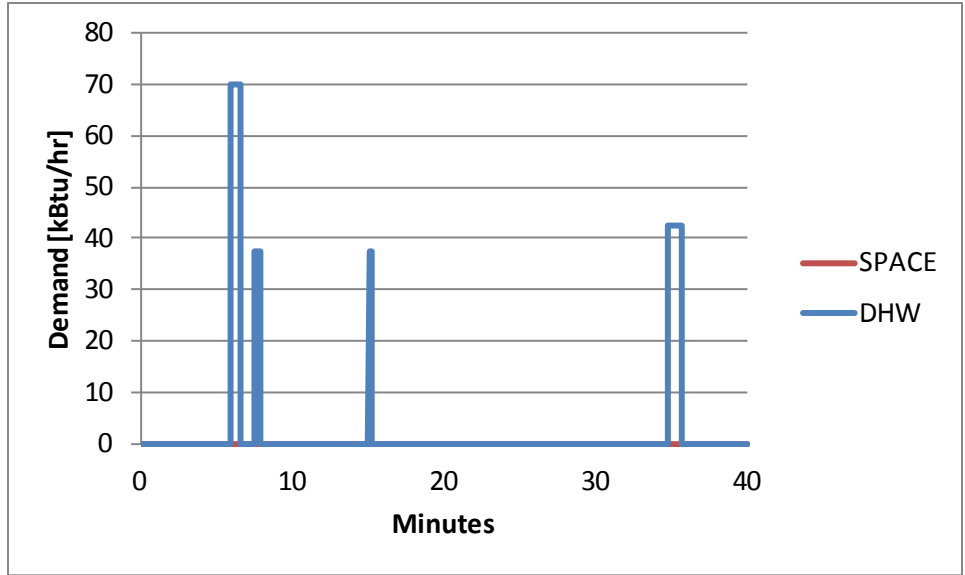

Figure 19. Low use load profile for full system tests

Table 6. Full System Test Load Profiles (Btu/h)

Max Capacity			DHW Interrupt			Low Use		
TIME	SPACE	DHW		SPACE	DHW		SPACE	DHW
0:00:00	40000	0	0:00:00	0	0	0:00:00	0	0
0:02:59	40000	0	0:02:59	0	0	0:05:56	0	0
0:03:00	40000	70000	0:03:00	0	57500	0:05:57	0	70000
0:05:29	40000	70000	0:04:59	0	57500	0:06:37	0	70000
0:05:30	40000	125000	0:05:00	40000	57500	0:06:38	0	0
0:14:47	40000	125000	0:08:30	40000	57500	0:07:33	0	0
0:14:48	40000	55000	0:08:31	40000	0	0:07:34	0	37500
0:15:29	40000	55000	0:15:29	40000	0	0:07:54	0	37500
0:15:30	40000	0	0:15:30	40000	0	0:07:55	0	0
0:20:00	40000	0	0:19:59	40000	0	0:15:04	0	0
			0:20:00	0	0	0:15:05	0	37500
						0:15:17	0	37500
						0:15:18	0	0
						0:34:46	0	0
						0:34:47	0	42500
						0:35:41	0	42500
						0:35:42	0	0
						0:40:00	0	0
Total Btu	13,333	22,864		9,989	5,271		0	1,749
	36,197			15,260			1,749	

4.4.1 Maximum Capacity

The “Maximum Capacity” profile consisted of two showers and a space heating load. The space heating load was consistent throughout the profile at 40,000 Btu/h.⁶ The first shower was 2 gpm for 12 min (approximately 70,000 Btu/h). The second shower, starting 2.5 min after the first, was 1.5 gpm and 10 min long (approximately 55,000 Btu/h). The systems were set to provide 120°F DHW supply water and the DHW inlet water temperature was about 60°F. Supply water temperatures from space heating and DHW outlets were compared at the beginning and end of the two-shower period. The beginning temperature was measured after the DHW outlet temperature stabilized for the first shower. Figure 20 shows the temperature comparison. The TWHs supplied the most consistent water temperatures, because the input ratings (199,000 Btu/h) were significantly higher than the demand (165,000 Btu/h). The storage WHs showed a 10°–30°F drop in DHW supply temperature and a 10°–30°F drop in space heating supply water temperature, which corresponded to a 5°–15°F drop in supply air temperature.

These systems showed temperature reductions when the storage capacity could no longer keep up with the difference in heating plant input (100,000 Btu/h) and desired load (165,000 Btu/h). All four boilers had DHW priority controls. This control strategy diverts all heating capacity to the DHW side when there are simultaneous events. Boiler 2 and Boiler 3 were able to provide consistent DHW supply temperatures through the high demand period. Boiler 1 had a smaller input (75,000 Btu/h) than the DHW demand (125,000 Btu/h), and therefore could not meet the two-shower load. The internal heat transfer capabilities of Boiler 4 limited the maximum hot water flow rate at 2.9 gpm. Therefore, Boiler 4 could not meet the two-shower demand of 3.5 gpm, which reduced the DHW supply temperature. These results were used to help develop the sizing recommendations presented in Section 4.6.

⁶ A 40,000 Btu/h space heating load was representative of the design load requirements of the combi implementation project housing stock. All houses were required to go through the weatherization process. Weatherization provided improved air sealing, increased insulation, and provided other measures that lowered the homes’ space heating loads.

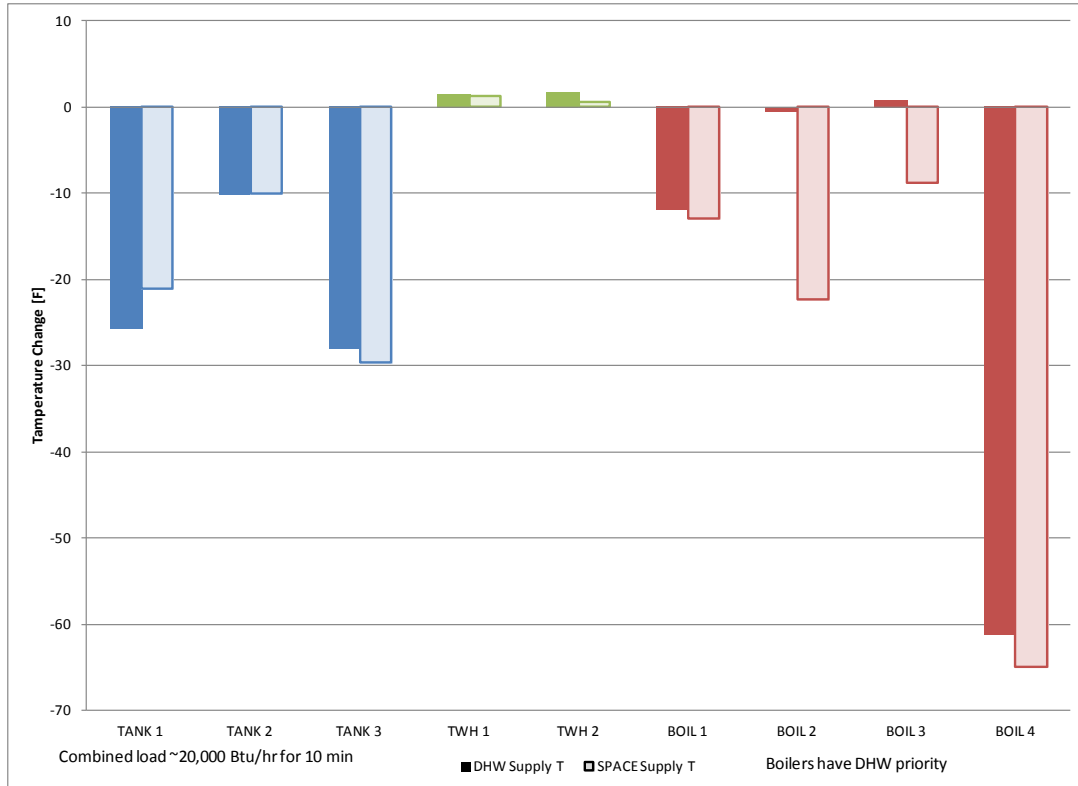

Figure 20. Difference in supply temperature from the start to end of a two shower and space heating demand

4.4.2 Response to Overlapping Events

The “DHW Interrupt” full system test profile was designed to test the effects of a space heating load initiated in the middle of a DHW draw. Changes in supply water temperature are especially important during showers. This draw pattern (Figure 18) consisted of 40,000 Btu/h space heating event starting 3 min into a 1.6-gpm shower event (17 min long at 57,500 Btu/h). Figure 21 shows the DHW temperature at the heating plant outlet for 10 s before and 15 s after the space heating load was added. The boilers and storage WHs all held constant outlet temperatures under the additional space heating load. The large quantity of stored hot water in the tank type WHs prevented a decrease in water temperatures. The boilers all have DHW priority, so when the space heating demand was initiated heat was not diverted from the DHW event. The DHW supply temperature for Boiler 4 was much higher than the set point (supply temperature/set point ≈ 1.3) and is not displayed in Figure 21. This performance of Boiler 4 seems to be some kind of control issue, where water temperature is not reduced enough. An additional mixing valve would help produce a hot water temperature at the fixture that would be closer to the set point.

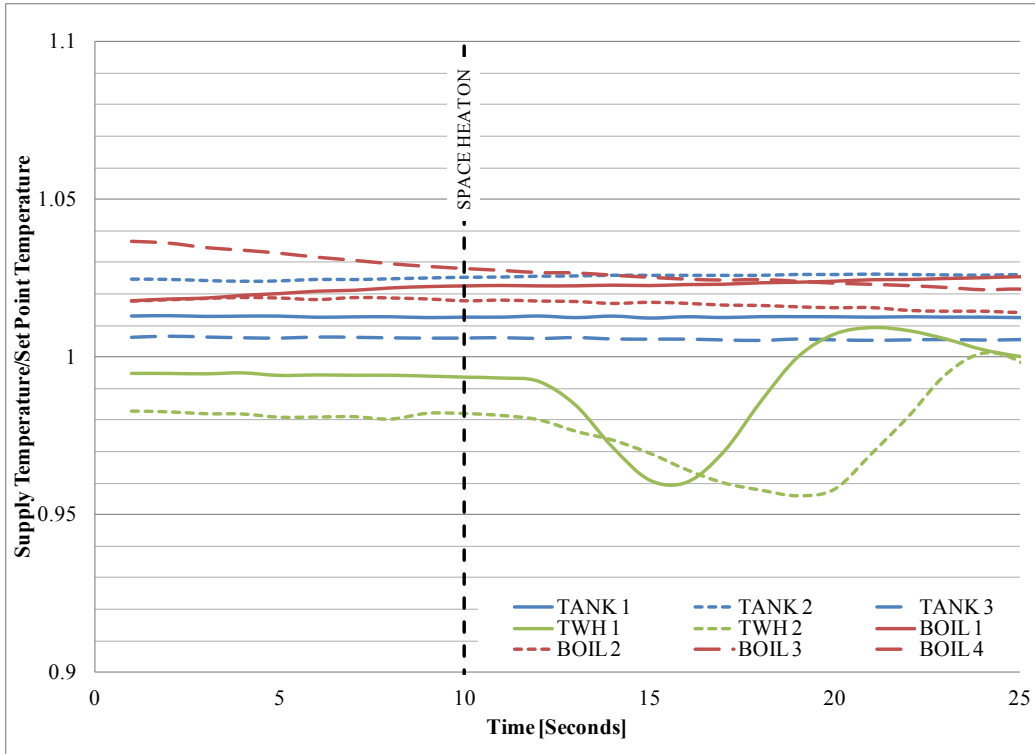

Figure 21. DHW supply temperature response when space heating demand was initiated

There was a significant drop in the supply water temperature at the outlet tap of the two TWHs, but the drop was significantly lower after the mixing valve.⁷ The maximum reduction was 5°F in both cases (TWH 1: $4.6^{\circ}\text{F}</math> and TWH 2: $3.6^{\circ}\text{F}</math>). Both TWHs had 2 min of inconsistent supply temperatures before returning to steady conditions. Figure 22 shows the TWH 1 supply water temperature at the outlet and after the mixing valve around the time of the space heating load. There was a $5^{\circ}\text{F}</math> dip in the DHW temperature at the WH outlet, but that dip was reduced to about $1^{\circ}\text{F}</math> after the mixing valve. The mixing valve also greatly reduced the length of the effect. The temperature became consistent at the mixing valve outlet in $<30\text{ s}</math>. The mixing valve had about 15 ft of plumbing between it and TWH 1; this pipe length and the mixing valve buffered the water temperature against the short-term transients.$$$$$

⁷ For the field monitoring portion of the project, all systems will be installed with mixing valves.

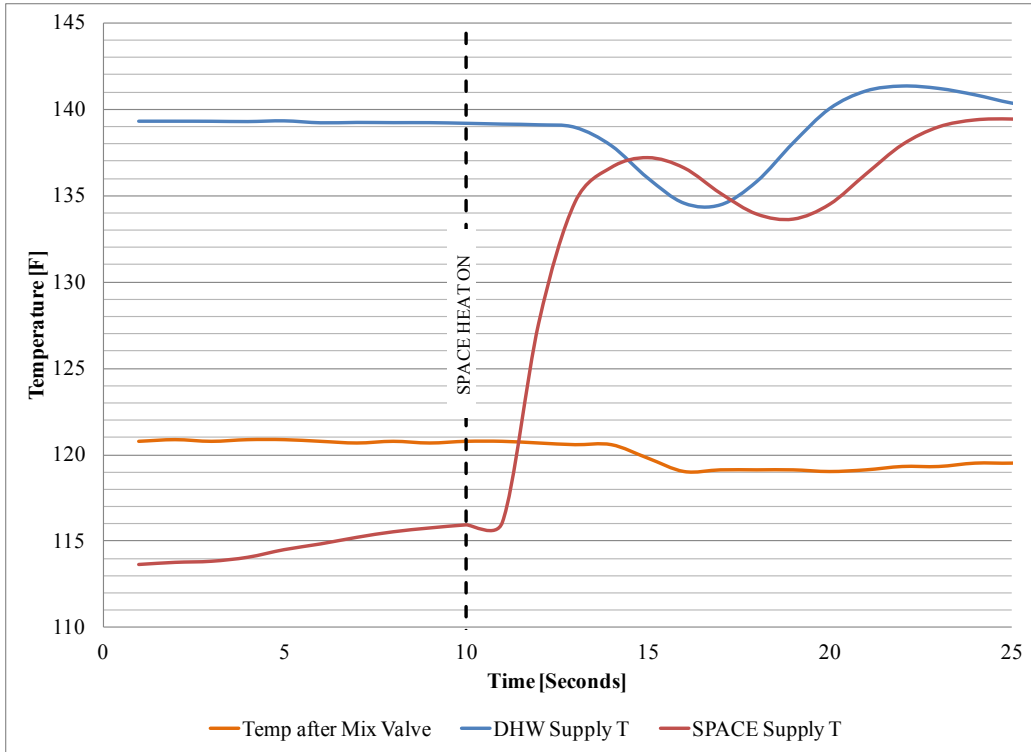

Figure 22. DHW temperature changes before and after the mixing valve for TWH 1

4.4.3 Domestic Hot Water Supply Temperature

The “Low Use” load profile was used to evaluate each combi system’s ability to produce hot water for small DHW events. Table 7 describes each draw used in this profile. The total draw for each test was 0.75 gal. Hot water supply temperatures were measured within 6 in. of the heating plant outlet.

Table 7. DHW Draw Characteristics for the Low Use Load Profile

Time	DHW Draw (gpm)	Load (Btu/h)
5:57	2.0	70,000
6:37	Off	0
7:34	1.1	38,000
7:54	Off	0
15:05	1.1	38,000
15:17	Off	0
34:47	1.2	42,000
35:41	Off	0

Figure 23 shows the temperature profile at startup for Draw 4 with a 1.2 gpm flow rate. The tank type WHs were the fastest responding heating plants. These systems reached 95% of their set points in <5 s. Tank type WHs provide hot water at consistent temperatures at or below the set point, depending on the width of the dead band and the length of time since the burner last fired.

For tests of these tank type WHs, the dead band was small (3°–7°F) and the burners had recently fired.

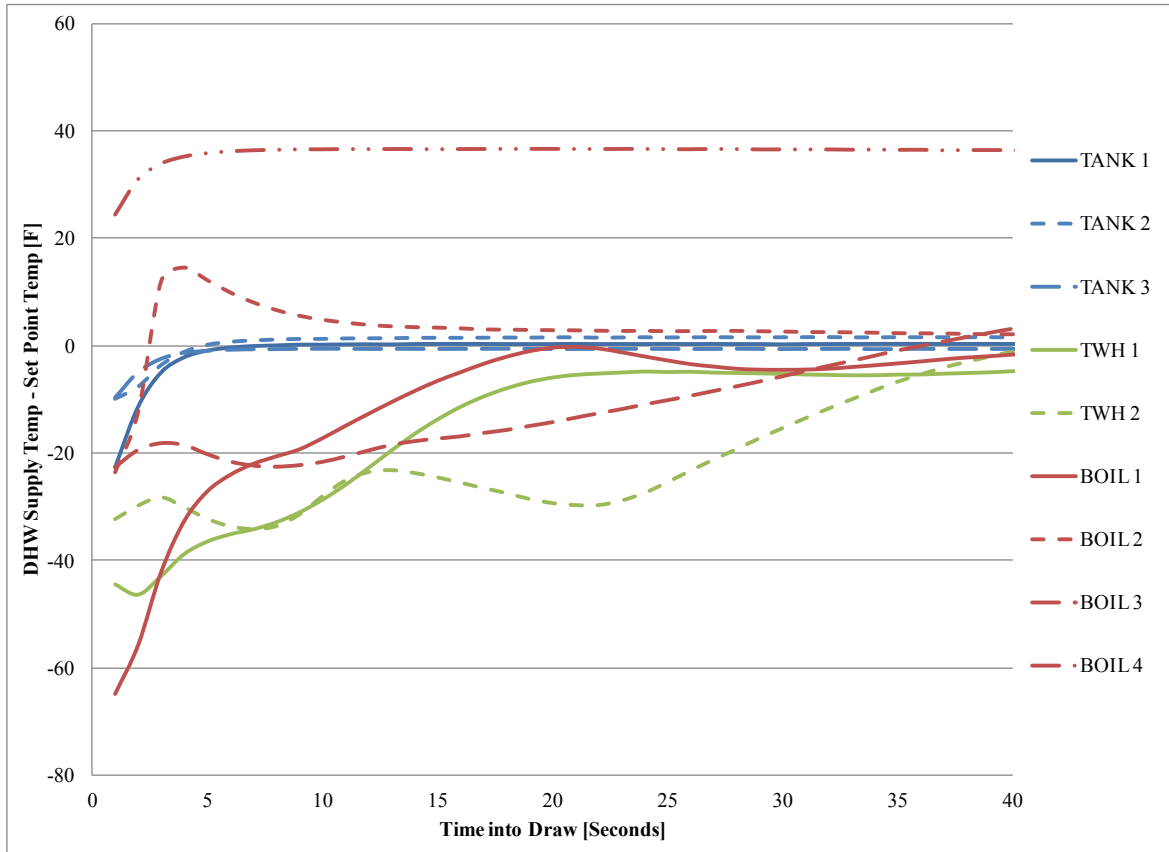

Figure 23. DHW supply temperature profile for a short 1.2-gpm draw

The two boilers with internal DHW tanks (Boilers 2 and 4) had temperatures higher than the set point for most draws. These heating plants store water at temperatures higher than the set point and mix in cold water to achieve the desired water temperature. Boiler 2 had a 10-s delay before it reached the desired temperature. Boiler 4 had a much longer delay, and the temperature was significantly over the set point for the duration of all four short draws of the “Low Use” profile. Boilers 1 and 3 were low mass boilers with no internal storage. These boilers had a ramp-up period before they reached the desired temperature.

With little or no storage capacity, increased delivery time is a concern for TWHs. The length of time a TWH requires to produce hot water relates directly to the length of time since the previous draw. If the heat exchanger is still filled with warm or hot water from a previous draw, hot water delivery time will be shorter than if the water in the exchanger had cooled. For draw 4 of the “Low Use” profile, about 20 min had passed since the previous draw. TWH 1 produced hot water within 20 s. TWH 2 had 2 gal of hot water storage but took twice as long as TWH 1 to produce hot water on draw 4. Figure 24 shows the temperature profiles for all four draws in the “Low Use” profile. The figure illustrates that TWH 2 performed better in earlier draws in the profile. However, incoming cold water mixing with the stored hot water caused inconsistent initial output on all draws. Delivery times increased as the storage capacity was used.

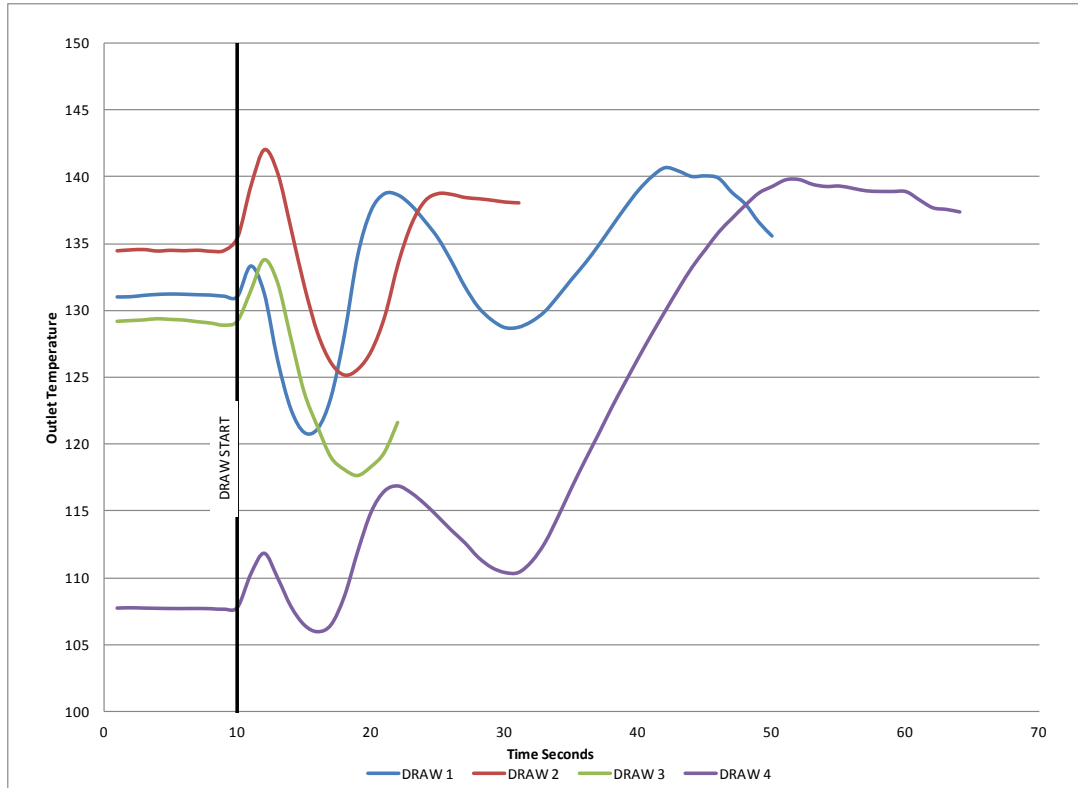

Figure 24. DHW supply temperature profile for TWH 2

Table 8 summarizes the low use performance of each system during the draw period, including the ratio of supplied water temperature to the set point temperature, the volume of hot water delivered that was with 95% of the set point temperature, and the time it took for each draw to reach 95% of the set point temperature. The heating plants with no storage (Boiler 1, Boiler 3, and TWH 1) have longer delivery times, less volume delivered at temperature, and a lower average water delivery temperature than heating plants with storage.

Table 8. DHW Performance of Combi Systems Under Small and/or Short Draw Conditions

Heating Plant	Set Point (°F)	Supply Temperature/Space Heating	Volume Within 95% of SP	Delay Until Within 95% of Set Point (s)			
				1 st Draw	2 nd Draw	3 rd Draw	4 th Draw
Boiler 1	156	0.92	49%	33	4	>12	15
Boiler 2	120	1.03	96%	3	3	3	3
Boiler 3	120	0.84	27%	27	0	>12	3
Boiler 4	120	1.32	100%	0	0	0	0
THW 1	140	0.89	6%	>40	>20	>12	19
TWH 2	140	0.92	47%	12	2	>12	41
Tank 1	140	1.00	97%	3	0	2	3
Tank 2	140	0.99	98%	5	1	4	4
Tank 3	140	1.01	97%	4	0	4	4

Note: Boilers 2, 3, and 4 have internal mixing valves that can be set by hand (Boiler 2) or by digital control (Boilers 3 and 4). Boiler 1 has no DHW temperature control; it is always set to 156°F and relies on an external mixing valve.

4.5 Installation Process and Specifications

The objective of the laboratory research was to develop guidelines for component selection, sizing requirements, and system installation. The results presented in previous sections were used to develop these guidelines and specifications. The first step in a combi installation is to measure or determine the key household characteristics: space and water heating loads, occupancy, distribution systems, and hot water end use.

The space heating load can be estimated from the building envelope characteristics and used to calculate the space heating design load. The home's gas utility billing history and corresponding outdoor temperatures can help verify the space heating estimates. The water heating load can be estimated with a survey of end uses and number of residents. For sizing purposes, the large hot water draws are more important than the total DHW load. The shower events are typically the largest and have the greatest impact on occupant satisfaction. The actual shower hot water flow rates provide more reliable sizing estimates, but person-to-person variance of flow, cold water temperature into the home, and shower temperature selection necessitates the use of typical values. Low-flow showerheads were recommended to replace showerheads with flow rates >2.0 gpm for the field phase of this project, to avoid excessive shower flow rates that cause occupant dissatisfaction.

Manufacturers of combi systems have not published sizing criteria. Contractors have traditionally sized systems on site. For this project the heating plant were sized to fit each home using the expected shower load and estimated space heating load. The natural gas burner input rate, storage capacity, and heating plant controls (DHW priority) are considered when sizing the system. Table 9 lists sizing guidelines for the three types of combi systems studied in this project. Each row corresponds to a heating plant that is being considered for use in the field monitoring phase of the project. The first four columns (type of heating plant, burner maximum input, water storage capacity, and DHW priority) characterized the combi system. The next six columns describe six load profiles. These columns indicate whether the system will be properly sized for the specified loads. For example, a boiler with 199 kBtu/h input, zero storage, and DHW priority would have 150% of the capacity needed in a 40-kBtu/h, one-shower home (resulting in a 50% oversize factor). A heating plant was listed as "small" if the required output was greater than the available capacity, resulting in the system being undersized. The loads in Table 9 were selected to represent the range of the housing stock considered. When sizing was done for a specific home, the estimated loads of that home were used.

Table 9. Combi System Sizing Chart

	Max Input kBtu/hr	Storage Gal	DHW priority?	SP: 40,000 Btu/hr		SP: 50,000 Btu/hr		SP: 60,000 Btu/hr	
				1 shw	2 shw	1 shw	2 shw	1 shw	2 shw
Boiler	75	0	Yes	small	small	small	small	small	small
	100	0	Yes	1%	small	1%	small	1%	small
	150	0	Yes	34%	small	34%	small	34%	small
	199	0	Yes	50%	13%	50%	13%	50%	13%
	75	6	Yes	small	small	small	small	small	small
	100	6	Yes	5%	small	5%	small	5%	small
	150	6	Yes	37%	small	37%	small	37%	small
	199	6	Yes	52%	15%	52%	15%	52%	15%
	75	12	Yes	small	small	small	small	small	small
	100	12	Yes	9%	small	9%	small	9%	small
	150	12	Yes	40%	small	40%	small	40%	small
	199	12	Yes	55%	17%	55%	17%	55%	17%
TWH	150	2	No	1%	small	small	small	small	small
	199	2	No	26%	small	19%	small	13%	small
	150	0	No	0%	small	small	small	small	small
	199	0	No	25%	small	19%	small	12%	small
	150	2	Yes	1%	small	small	small	small	small
	199	2	Yes	26%	small	19%	small	13%	small
	150	0	Yes	0%	small	small	small	small	small
	199	0	Yes	25%	small	19%	small	12%	small
TANK	100	55	No	small	small	small	small	small	small
	150	50	No	25%	small	16%	small	7%	small
	199	50	No	58%	5%	46%	small	35%	small
	100	80	No	7%	small	small	small	small	small
	150	80	No	40%	small	29%	small	20%	small
	199	80	No	73%	15%	60%	9%	48%	4%
	100	50	Yes	small	small	small	small	small	small
	150	50	Yes	25%	small	16%	small	7%	small
	199	50	Yes	58%	5%	46%	small	35%	small
	100	80	Yes	7%	small	small	small	small	small
	150	80	Yes	40%	small	29%	small	20%	small
	199	80	Yes	73%	15%	60%	9%	48%	4%

Note: The SP value refers to the space heating load and 2 shw refers to two simultaneous showers.

An appropriate AH can be selected based on the space heating demand and heating plant. AH testing is described in Section 4.3 and summarized in Figure 13, Figure 14, Figure 15, and Table 5 can be used to select the correct AH. An AH with an optimized capacity range that matches the space heating demand of that home should be selected. The AH charts can then be used to select space heating water flow and airflow rates that allow for air temperatures >110°F with a return water temperature <105°F. These conditions will minimize the energy consumption of the combi

system. It may be necessary to allow for return water temperatures up to 110°F for some large demand applications. An increase in return water temperature would decrease system efficiency.

A DHW mixing or tempering valve will be included on every combi system in the field. A mixing valve blends the heating plant DHW supply water with cold inlet water to produce the hot water supplied to the fixtures. Space heating supply water temperatures are often required to be >120°F to meet the demand at an acceptable supply air temperature. A heating plant operating at temperatures >120°F carries an increased risk of scalding. Figure 23 and Figure 24 show supply water temperatures exceeding 140°F. The DHW loop of each system will include a mixing valve. The thermostatic nature of mixing valves also helped to reduce some of the transient changes in supply water temperature.

Several of the heating plants have outdoor temperature setback capabilities. This control method reduces the storage and supply water temperatures of the heating plant as the outdoor temperature increases. Figure 25 shows a typical outdoor temperature reset curve. Reducing the supply water temperature as the outdoor temperature increases helps match the space heating output to the house heating demand. Lowering the supply water temperature reduces the standby losses and increases the steady-state efficiency. The reduced space heating output would also increase the duration of the heating cycles. Outdoor reset has the potential to improve system efficiency in the shoulder and summer seasons. The 300 home implementation project will use resets where possible. Outdoor resets have two potential drawbacks that limit their use. Reducing the supply water temperature will reduce the supply air temperature and output capacity. Lower supply air temperatures could cause comfort problems, and less output capacity would increase setback recovery times. These two drawbacks must be considered in the design and optimization of the system if outdoor reset is to be used.

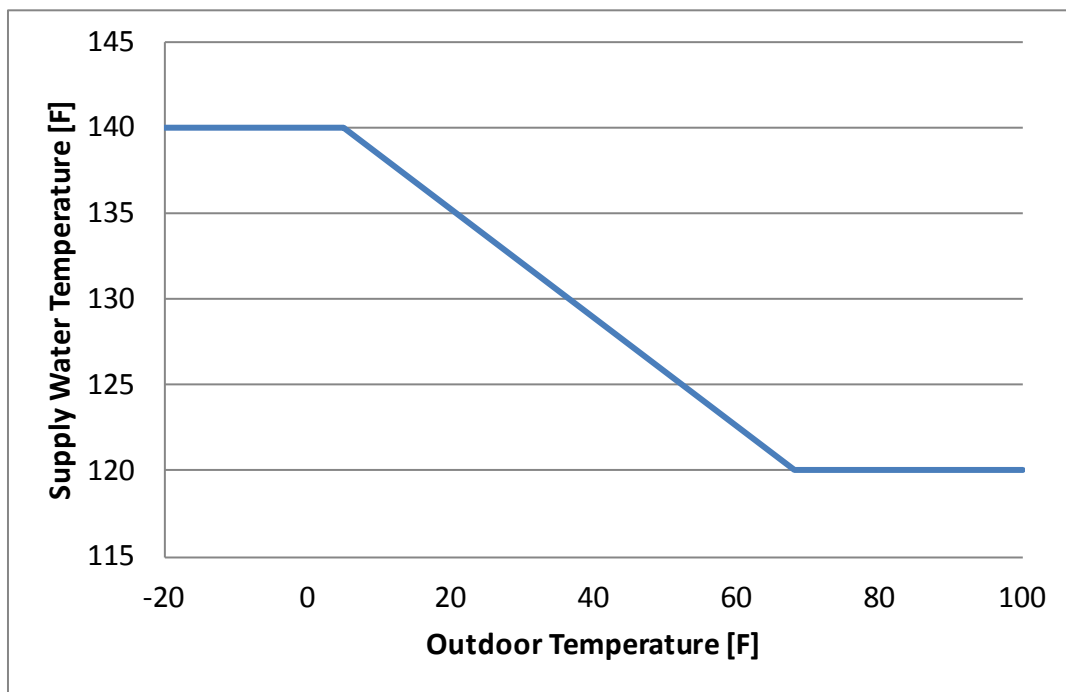

Figure 25. Typical outdoor setback temperature control curve

5 Discussion

5.1 Air Handler Improvement

Most currently available hydronic AHs were not designed for combi systems with a condensing heating plant. Therefore, low return water temperatures were not prioritized and there was little cross-flow performance of the coils. Counter-flow heat exchangers are designed with the water flow and airflow paths in opposite directions, so that the water leaving the heat exchanger transfers heat to the entering cool air. The hydronic AHs were configured with counter-flow patterns, but the coil geometries did not produce counter-flow performance. Only one AH was able to deliver air temperatures more than a couple degrees above the return water temperature. This was significant because the conditions required for optimized heating plant efficiency and homeowner comfort (in retrofit applications) were $<105^{\circ}\text{F}$ return water temperature and $>110^{\circ}\text{F}$ delivered air temperature.

All potable rated hydronic AHs had the heating loop pump inside. Building codes require an integral control to prevent coil water stagnation by running the circulating pump when there is a long period with no heating demand. All but one of these pumps had a single speed that could not be adjusted. Fixed-speed pumps require a balancing valve in the circulation loop to reduce the water flow rate for optimal AH and heating plant performance. The only variable-speed pump was manually controlled, forcing the installer to select the speed. This was an improvement over the fixed-speed pumps, but could have been even better had the pump controls changed the pump speed with demand so an increased output could be delivered on colder days or during periods with higher demand (e.g., recovery from thermostat setback).

All the AHs had multiple fan speeds. The range of available speeds often increased as coil size increased, creating a situation where it was difficult to deliver acceptable air temperatures in the high capacity units. Once the fan speed was selected, it did not adjust to load changes. A simple control could allow an AH to meet a large load (e.g., morning setback) more quickly. This control could increase the fan speed once a certain runtime was met. For example, if the base fan speed produced 800 cfm and there was a continuous call for heat for 10 min, the fan speed would increase to deliver 1200 cfm.

5.2 Heating Plant Improvement

The primary/secondary boiler loop configuration presents a significant obstacle to high efficiency space heating. Figure 26 shows the combi boiler installation from one manufacturer. All combi boiler manufacturers have similar plumbing diagrams. Manufacturers require the primary/secondary loop to control the flow rate of water through the boiler. There is a concern that overheating could damage the boiler, even causing it to explode, if the flow rate is too low and air is in the water loop. This configuration increased return water temperatures. There was mixing within the primary loop while meeting a space heating demand. Flow rates in the primary loop, typically a fixed rate set by the boiler, and the secondary loop, a fixed rate set by the AH, affected the extent of mixing. The system efficiency optimization typically specified flow rates in the secondary loop to be about half the flow rate of the primary loop. This setup allowed for a large amount of mixing and an estimated $5^{\circ}\text{--}20^{\circ}\text{F}$ increase between the water temperature returning from the AH and entering the boiler. The magnitude of the temperature change depended on the flow rates, water temperatures, and plumbing configuration. This temperature

increase related to about a 3%–11% system efficiency reduction, or a potential \$40–\$200 annual increase in space heating energy cost (assuming \$1/therm of natural gas).

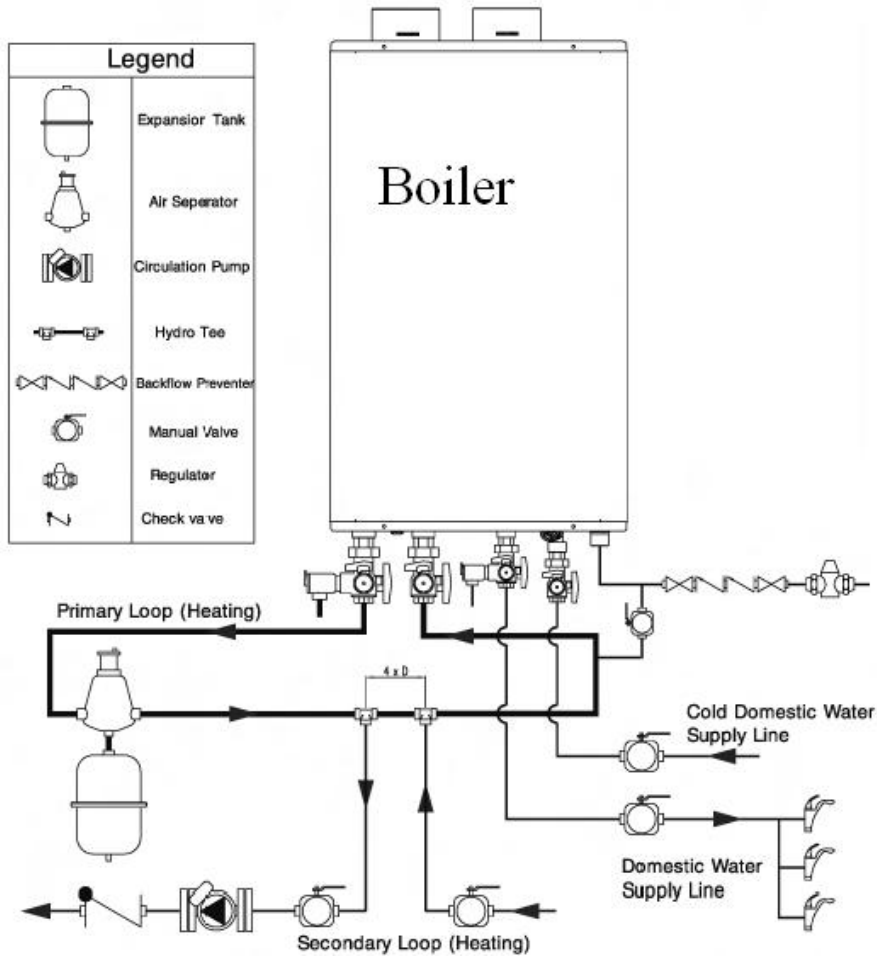

Figure 26. Typical combi system installation with a boiler

6 Conclusions

The highest system efficiencies were achieved by minimizing the water temperatures returning from the hydronic AH. Heating loads were determined for each site. These loads were used to select the water flow rates and airflow rates that would result in low return water temperatures while meeting the necessary load with an acceptable air temperature. Laboratory tests showed that the heating plant steady-state efficiency decreased with increasing return water temperature. The decrease in efficiency became more significant as the return temperature increased above 110°F.

Laboratory testing verified that heating loads up to 50,000 Btu/h with acceptable return water temperatures and supply air temperatures. These designs provide steady-state space heating efficiencies >85%.

System design and sizing information developed in the laboratory is currently being used to optimize systems for the 300 site implementation project. The laboratory work has been invaluable to this process. The installers and program managers have confidence that these systems will meet the needs of the homeowners because of laboratory tests.

The performance of combi systems is limited by the currently available equipment. Several manufacturers, at least one in direct reaction to the findings from this project, have begun to improve combi equipment. AHs with improved heat transfer performance will allow for lower and lower return water temperatures. Improved controls will enable adjustment and continuous optimization.

7 References

- Arena, L. (2011). *Building America Systems Evaluations: In-Field Performance of Condensing Boilers in Cold Climate Region*. Steven Winters Associates, Inc.
- Bohac, D.; Hancock, M.; Dunsworth, T.; Makredes, S. (1995). *Energy Savings and Field Experiences with Dual Integrated Appliances*. Proceedings paper. Minneapolis, MN: Center for Energy and Environment, August 1. <http://aceee.org/proceedings-paper/ss94/panel03/paper02>.
- Butcher, T. (2011). “The DHW Performance of Heating Boilers.” Presented at the ACEEE Hot Water Forum, May 11, Berkeley, CA.
www.aceee.org/files/pdf/conferences/hwf/2011/7A%20-%20Tom%20Butcher.pdf.
- Energy Conservatory. (2008). TrueFlow Air Handler Flow Meter.
www.energyconservatory.com/download/trueflow.pdf.
- Rudd, A. (2010). *Building America Special Research Project: Space Conditioning Systems for High Performance Home*. Research report. Building Science Corporation, November 15.
- Schoenbauer, B, Hewett, M.; Bohac, D. (2011). “Actual Savings and Performance of Natural Gas Instantaneous Water Heaters.” *ASHRAE Transactions* 117 (1): 657–672.
- Thomas, M. (2011). “Designing a Highly Efficient Combination Space/Water Heating System.” Presented at the ASHRAE Annual Conference, June 26, Montreal.

buildingamerica.gov

U.S. DEPARTMENT OF
ENERGY | Energy Efficiency &
Renewable Energy

DOE/GO-102012-3694 • October 2012

Printed with a renewable-source ink on paper containing at least 50% wastepaper, including 10% post-consumer waste.