



Economic On-Grid Solar Energy via Organic Thin Film Technology

28 September 2007 – 27 October 2008

D. Laird, J. Bernkopf, S. Jia, J. Krieg, S. Li,
C. McGuinness, J. Rossier, M. Storch, R. Tipnis,
R. Tuttle, B. Woodworth, and S. Williams
Plextronics, Inc.
Pittsburgh, Pennsylvania

Subcontract Report
NREL/SR-520-47289
December 2009

NREL is operated for DOE by the Alliance for Sustainable Energy, LLC

Contract No. DE-AC36-08-GO28308



Economic On-Grid Solar Energy via Organic Thin Film Technology

Subcontract Report
NREL/SR-520-47289
December 2009

28 September 2007 – 27 October 2008

D. Laird, J. Bernkopf, S. Jia, J. Krieg, S. Li,
C. McGuinness, J. Rossier, M. Storch, R. Tipnis,
R. Tuttle, B. Woodworth, and S. Williams
Plextronics, Inc.
Pittsburgh, Pennsylvania

NREL Technical Monitor: Bolko von Roedern
Prepared under Subcontract No. NAT-7-77015-06

National Renewable Energy Laboratory
1617 Cole Boulevard, Golden, Colorado 80401-3393
303-275-3000 • www.nrel.gov

NREL is a national laboratory of the U.S. Department of Energy
Office of Energy Efficiency and Renewable Energy
Operated by the Alliance for Sustainable Energy, LLC

Contract No. DE-AC36-08-GO28308

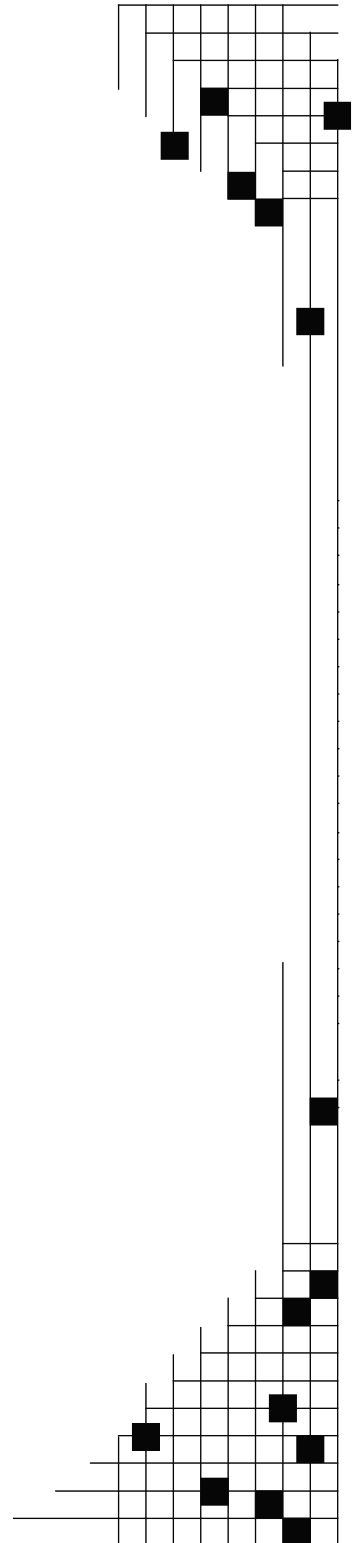

**This publication was reproduced from the best available copy
Submitted by the subcontractor and received no editorial review at NREL**

NOTICE

This report was prepared as an account of work sponsored by an agency of the United States government. Neither the United States government nor any agency thereof, nor any of their employees, makes any warranty, express or implied, or assumes any legal liability or responsibility for the accuracy, completeness, or usefulness of any information, apparatus, product, or process disclosed, or represents that its use would not infringe privately owned rights. Reference herein to any specific commercial product, process, or service by trade name, trademark, manufacturer, or otherwise does not necessarily constitute or imply its endorsement, recommendation, or favoring by the United States government or any agency thereof. The views and opinions of authors expressed herein do not necessarily state or reflect those of the United States government or any agency thereof.

Available electronically at <http://www.osti.gov/bridge>

Available for a processing fee to U.S. Department of Energy
and its contractors, in paper, from:

U.S. Department of Energy
Office of Scientific and Technical Information
P.O. Box 62
Oak Ridge, TN 37831-0062
phone: 865.576.8401
fax: 865.576.5728
email: <mailto:reports@adonis.osti.gov>

Available for sale to the public, in paper, from:

U.S. Department of Commerce
National Technical Information Service
5285 Port Royal Road
Springfield, VA 22161
phone: 800.553.6847
fax: 703.605.6900
email: orders@ntis.fedworld.gov
online ordering: <http://www.ntis.gov/ordering.htm>



Table of Contents

| | |
|------------------------------|----|
| Project Summary..... | 1 |
| Milestone #1..... | 2 |
| Milestone #2..... | 5 |
| Milestone #3..... | 6 |
| Milestone #4..... | 7 |
| Milestone #5..... | 8 |
| Milestone #6..... | 9 |
| Milestone #7..... | 11 |
| Milestone #8..... | 12 |
| Milestone #9..... | 14 |
| Milestone #10..... | 15 |
| Milestone #11..... | 17 |
| Milestone #12..... | 18 |
| Milestone #13..... | 20 |
| Milestone #14..... | 21 |
| Milestone #15..... | 25 |
| Milestone #16..... | 26 |
| Milestone #17..... | 27 |
| Milestone #18..... | 30 |
| Milestone #19..... | 31 |
| Milestone #20..... | 32 |
| Milestone #21..... | 34 |
| Milestone #22..... | 35 |
| Milestone #23..... | 36 |
| Milestone #24..... | 37 |
| Milestone #25..... | 38 |
| Milestone #26..... | 39 |
| Conclusions and Outlook..... | 40 |

Project Summary

Plextronics, Inc. was awarded the U.S. Department of Energy's (DOE) Solar America Initiative (SAI) PV-Incubator contract in 2007. The goal of the program was to take its Organic Photovoltaic (OPV) technology from laboratory-scale and demonstrate a pathway to 3MW manufacturing capacity (~2010) and 7c/kWh LCOE by 2015. The program supports the Solar Energy Technology Program (SETP) charter as follows:

1. Driving **commercialization** of novel, low-cost thin film PV technology via development of commercial high performance OPV inks to enable production of modules.
2. Systematic, quantitative evaluation of technological options on the pathway toward **achieving grid parity** with conventional sources of power.
3. Demonstrating an OPV module development line and utilizing it as a pathway toward establishing high volume manufacturing facility that will eventually contribute to **U.S. installed domestic capacity** for PV systems.

Plextronics employed a three-pronged approach to meet the Incubator goals:

1. Driving device efficiency via materials development
2. Improved stability and lifetime via device design and process development
3. Translating laboratory-scale performance to large-area modules via establishment of a pilot manufacturing-development line (D-Line) to evaluate manufacturing-worthy processes

Table 1 below summarizes Plextronics' deliverables for the program; because the program was driven by deliverables, this final report largely summarizes the individual deliverables.

Table 1: Deliverables for PV-Incubator Program

| Phase | # | Deliverable |
|----------|----|---|
| PHASE I | 1 | Report on baseline lab-cell (Efficiency = 5.1% (NREL-certified); Lifetime = 700 hours at 2 sun; 85 °C) and module (Efficiency = 0.8% (internally tested)) performance |
| | 2 | Report on lab-cell (Efficiency = 5.4% (internally tested)) performance |
| | 3 | Report on LCOE of OPV module |
| | 4 | Quarterly report |
| | 5 | Deliver a Lab-Cell sample (Efficiency = 5.4% (NREL-certified)) |
| | 6 | Report on design and fabrication of pre-production prototype module (Efficiency = 1% (internally tested)) |
| | 7 | Report & update on LCOE model |
| | 8 | Quarterly report |
| | 9 | Report on prototype manufacturing |
| | 10 | Report on lab-cell performance (Lifetime > 3723 hours) |
| | 11 | Report & update on LCOE model |
| | 12 | Deliver a prototype module (Efficiency = 1.5% (NREL-certified); Lifetime > 2000 hours) |
| | 13 | Stage-gate review and progress report |
| PHASE II | 14 | Quarterly report |
| | 15 | Quarterly report |
| | 16 | Lab-cell with 5.8% efficiency (NREL-certified) |
| | 17 | Lab-cell with 5,776 hours lifetime |
| | 18 | Module with 3.5% (active area) Efficiency (NREL-certified) |
| | 19 | Module with 5,000 hours Lifetime |
| | 20 | Module with 2% active area efficiency-0.82% total area efficiency (NREL-certified) |
| | 21 | Module with 1000 hours light-soaking (100% duty cycle) near 25 °C, >1.6% final active area efficiency (0.66% total area) (NREL-certified) |
| | 22 | Data comparison after 1000 hours Lifetime (outdoor) |
| | 23 | Demonstrate 9s6p Module, verify >1.5% active area efficiency (0.70% total area efficiency) (NREL-certified) |
| | 24 | Module with 500 hours light-soaking (100% duty cycle) Near 25 °C, initial efficiency >2.5%, final efficiency >2% (1.2% and 0.93% total area efficiency) (NREL-certified) |
| | 25 | Module with 500 hours light-soaking near 85 °C 85% RH, Stability after 200 hours to be >50% of original, test to be conducted on module with >2% active area efficiency (0.93% total area efficiency) |
| | 26 | Draft Final Report |
| | 27 | Final Report |

MILESTONE #1: Report Summarizing Baseline Lab-Cell and Module Performance.

KEY METRICS: Efficiency = 5.1% (NREL-certified) for lab-cell and 0.8% (internally tested) for module; Lifetime (lab-cell) = 700 hours.

1.1 Lab-cell devices

1.1.1 Efficiency

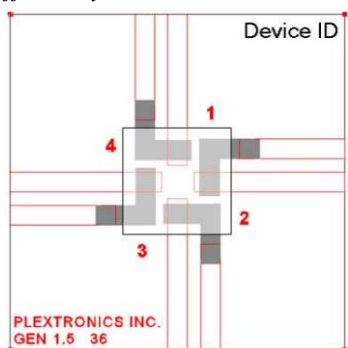

Figure 1: Plextronics' lab-cell design

Devices were fabricated on 50mm × 50mm patterned ITO-coated glass substrates (~ 20 ohm/square). Figure 1 shows the design layout of our lab-cell (4 cells per substrate). Substrates were cleaned by sonication in acetone and isopropanol, dried and UV-Ozone treated. A 30 nm hole-transporting layer was spin-coated on top of the ITO, and annealed. The active layer, based on proprietary p- and n-type semiconductors, was spin-cast and annealed. The cathode (typically Ca/Al) was thermally deposited (10⁻⁶ mbar). Devices were encapsulated in nitrogen glove box with a cavity glass with desiccant. Cell area measurements conducted on cells sent to NREL vary between 0.089 and

0.096 cm² and are used for internal efficiency calculations. Figure 2 shows the data for an OPV cell certified at NREL to exhibit 5.1% efficiency.

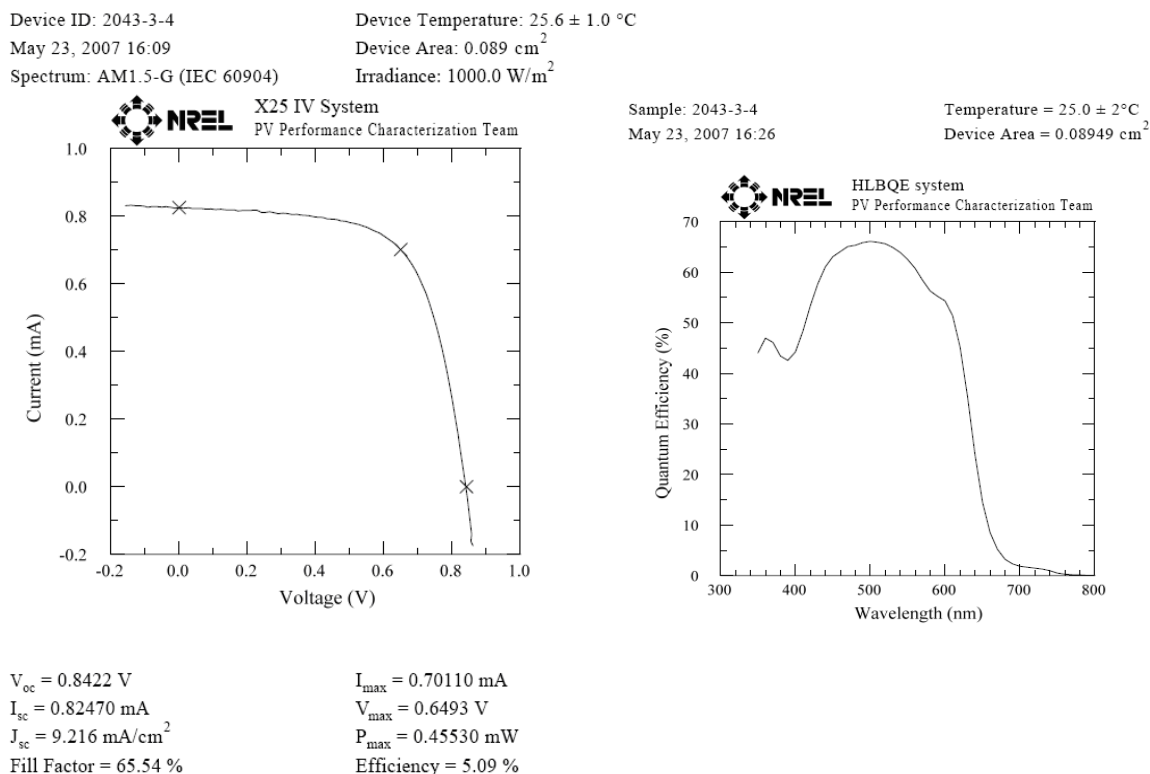

Figure 2: I-V and EQE spectrum of OPV device certified to 5.1% at NREL

1.1.2 Lifetime

Plextronics defines lifetime as the duration over which an OPV device or module diminishes to 80% of its 'stabilized' power output (or power conversion efficiency), normalized by the illumination intensity (lamp variation or decay) under ~ 1 Sun Xe-arc lamp with (or converted to) 50% duty cycle. Devices were tested outdoors (roof-top - at our labs in Pittsburgh) and were kept at either a 45 degree or 5 degree angle with respect to the horizon facing south with a direct exposure to the sun from the horizon to the

zenith. The devices were periodically tested under solar simulation (AM1.5G, 100 mW/cm²). The device parameters like short circuit current density (J_{SC}), open circuit voltage (V_{OC}), fill factor (FF) and efficiency were monitored over time. Following lifetime data show two representative devices based on P3HT:PCBM and proprietary active layers (Figure 3). The test exhibits devices operating above T90 after more than 750 hours.

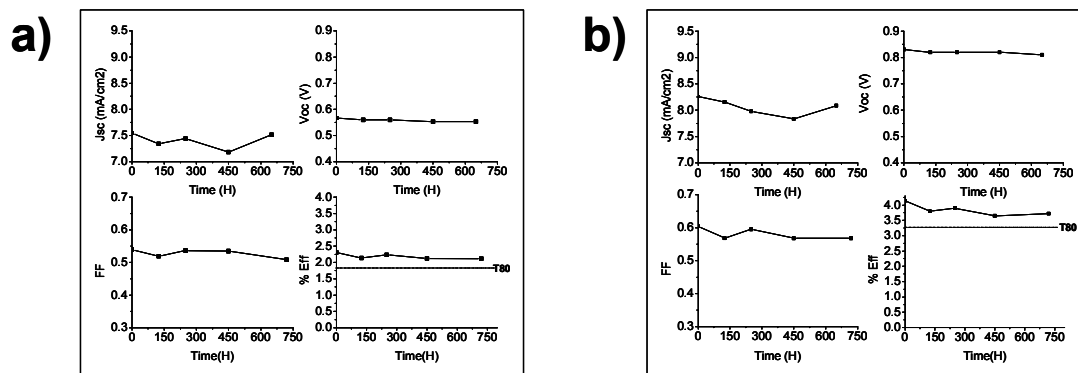

Figure 3: Un-accelerated roof-top outdoor lifetime data for (a) P3HT:PCBM (left) and (b) Proprietary active layer (right) devices. T80 is given on the efficiency vs. time plot.

1.2 OPV Modules

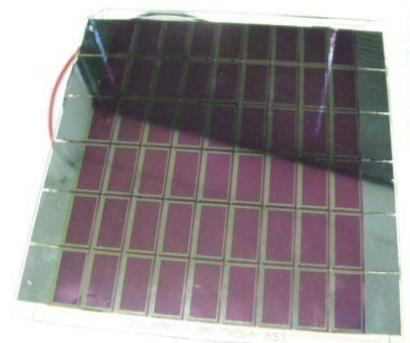

Figure 4: Plextronics' OPV module

Devices were fabricated on 150mm × 150mm patterned ITO-coated glass substrates (~ 20 ohm/square) with metal grid. Substrates were initially pre-cleaned in SRD machine and then cleaned in large ultrasonic baths in acetone and isopropanol, dried and UV-Ozone treated. A 30 nm hole-transporting layer was spin-coated on top of the ITO, and annealed. The photoactive layer is a blend of regioregular poly(3-hexylthiophene) (P3HT) and [6,6]-phenyl C61 butyric acid methyl ester (C60-PCBM) with a ratio 1.2:1. These active layers were spin cast on large Headway Research PWM32 spinner and annealed in glove box. The cathode (typically Ca/Al) was thermally deposited (10⁻⁶ mbar). Devices were encapsulated in nitrogen glove box

with a cavity glass with desiccant. Figure 4 shows the module that comprises of 54 × 2 cm² cells, totaling 108 cm² active area.

External quantum efficiency (EQE) measurements were done with chopped monochromatic light using an Oriel 250 W Quartz Tungsten Halogen Source, a SR540 optical chopper (17 Hz), an order-sorting filter wheel and a Cornerstone 130 1/8m Monochromator System with focusing optics. Short-circuit photocurrent from OPV device was detected with a SR570 low-noise current preamplifier and SR830 DSP dual phase lock-in amplifier. The incident light intensity from a monochromator was measured with a calibrated Si photodiode (Hamamatsu S1336-44BK). Encapsulated devices were characterized under standard AM1.5G test condition in ambient conditions. An 8" Thermo Oriel solar simulator with the AM1.5G filter assembly and power intensity of 78 mW/cm² was utilized to test the modules. The intensity of the light source was adjusted using an NREL-certified KG-5 filtered silicon cell to achieve the measured current under AM1.5G. The short-circuit current was adjusted for the spectral mismatch factor (M) between the solar spectrum and the light. Current voltage data were collected using a Keithley 2400 source measure unit. Figure 5 depicts the performance of internally tested 150mm × 150mm OPV module measured to have an active area efficiency of 1.07%.

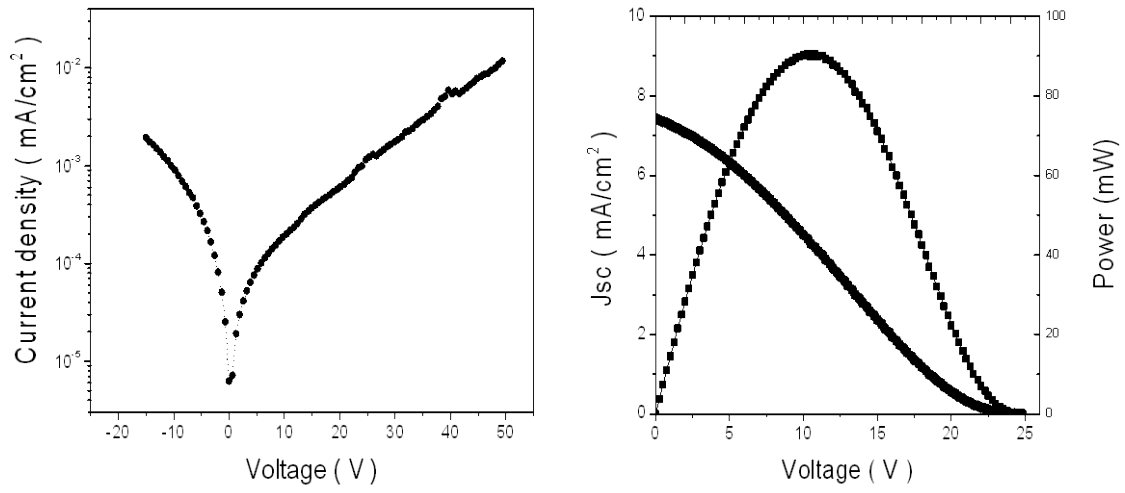

Figure 5: I-V and Power-Voltage data of 150mm × 150mm OPV module; Intensity = 78 mW/cm²

MILESTONE #2: Report On Lab-Cell Performance.

KEY METRICS: Efficiency = 5.4% (Internally Tested).

The devices were fabricated on 50mm × 50mm substrate as per the procedure described earlier. The active layer comprises of proprietary p- and n-type materials. The devices were tested under a Xe-arc solar simulator with AM 1.5G filter. The intensity of the light source (100 mW/cm²) was adjusted using an NREL-certified KG-5 filtered silicon cell to achieve the measured current under AM1.5G. The short-circuit current was adjusted for the spectral mismatch factor (M) between the solar spectrum and the light. Figure 6 shows the data for an internally-tested lab-cell device which was measured to have an efficiency of 5.51%.

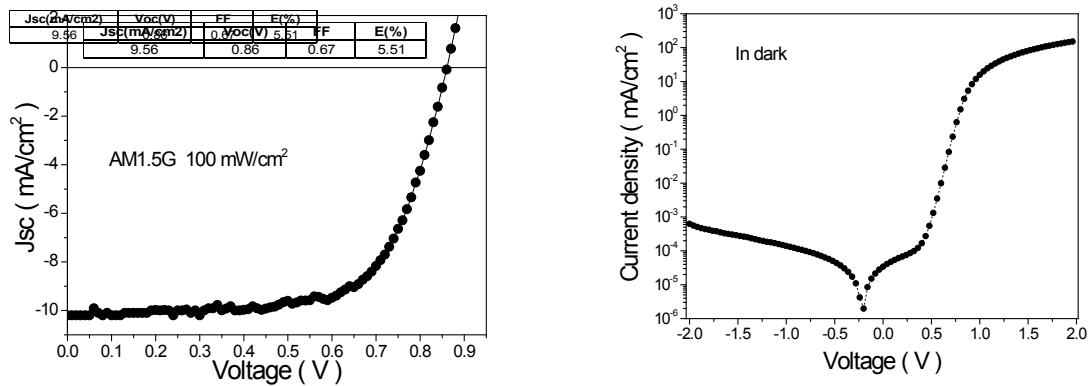

Figure 6: J-V characteristics of device under AM1.5G 100 mW/cm² (left) and in dark (right).

MILESTONE #3: Report on LCOE of OPV Module.

This report was an explanation of the Levelized Cost of Electricity (LCOE) model used by Plextronics to justify its SAI projections. It included a discussion of the calculation methodology as well as the assumptions that went into the calculations.

Solar modules based on OPV materials currently have a shorter lifetime than their silicon and thin film-based counterparts currently on the market. Because of this, these modules cannot simply be installed and left to produce power as more traditional silicon modules can be. Instead, the OPV modules will require periodic replacement to maintain their output. The calculation of LCOE needs to be modified to account for the additional cost of these replacements. Similarly, because the modules are degrading faster and then being replaced, the production function is very different from traditional silicon technologies that have a slow, steady degradation over time. Instead, the production associated with OPV-based solar modules will have peaks associated with the installation of new modules followed by more rapid degradation until replacement when the production would experience another peak. Additionally, as OPV technology is progressing rapidly to higher efficiencies, the peak production level associated with the replacement will also increase over time. This report outlined the details of this module replacement model.

3.1 Swap Out Model

The lifetime production of the system is measured by discounting each year's production to a base year for comparison. To compare OPV with other competing technologies, we need to use the same period for comparison. While a silicon-based solar module can be put into service and will operate for 20 years or more before replacement is required, OPV will require the modules to be swapped out periodically to maintain the desired level of output. In our model, the frequency of replacement under this "swap out" model is determined by setting a minimum acceptable percentage of the original output. When the module's output drops below this threshold, the module will be replaced.

The total lifetime output for a given project is found by combining the efficiency and degradation trajectories to obtain an overall production function for the solar farm being modeled. Figure 7 shows the characteristic "sawtooth" production function resulting from the swap out model we have employed for OPV.

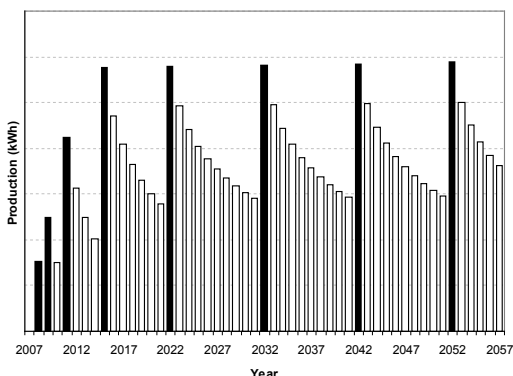

Figure 7: Annual production assuming module swap out at 50% of original output. Dark bars represent years of module replacement.

There are a number of features of this production function which warrant discussion. Most important, are the spikes in production associated with the swapping out of older modules with newer, more efficient ones (shown as dark bars). It can clearly be seen that the height of the peaks increases sharply in early years, mirroring the rapid rise in the module efficiency trajectory. Also, improved performance allows modules to operate longer before needing to be replaced. This is seen as an increase in the number of years between module replacements, corresponding to the dark bars in Figure 7.

Though they are based on very different production models, comparing the results of our modeling with NREL's Solar Advisor Model (SAM) can provide

validation for the calculation methodology employed.

MILESTONE #4: Quarterly Report.

A report was submitted summarizing the deliverables to date. We also reported on internally measured lab-cell efficiency of 5.7%, and provided an update on the outdoor lifetime measurements on lab-cells (data from Figure 3) that were operating above T75 after more than 3800 hours of test. An examination of these roof-top data helped us determine that these devices undergo a “burn-in” of performance within the first 1500 hours of roof-top exposure. This burn-in typically reduces initial device efficiency by 20%. However, the devices then entered a very stable phase of operation in which the degradation of devices was significantly slowed. We termed this point ‘The initial stabilized cell efficiency’, which is used as the starting point for determining cell lifetime. Lifetimes of greater than 5000 hours were projected from such analysis. The proprietary active layer is a promising technology over the standard P3HT:PCBM control in regards to the higher efficiencies and comparable stability. Figure 8 shows the updated data from the outdoor testing of lab-cell devices.

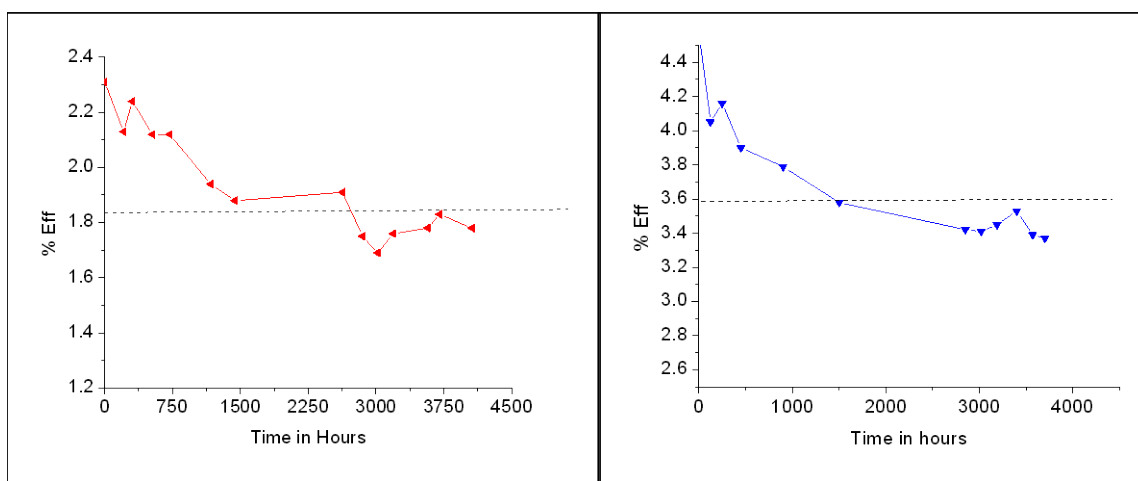

Figure 8: Un-accelerated roof-top outdoor lifetime data for (a) P3HT:PCBM (left) and (b) Proprietary active layer OPV (right) devices. T80 is given on the efficiency vs. time plot.

MILESTONE #5: Deliver A Lab-Cell Sample.

KEY METRICS: Efficiency = 5.4% (NREL-certified).

Plextronics' internal testing of cells has been shown to be nearly identical to NREL test data for the V_{OC} and FF cell parameters. The I_{SC} measurement, in which our data typically correlates to 0.95 – 1.02x of the NREL measured I_{SC} , verifies a good correlation of our solar simulation with NREL data. The highest source of error between the two systems is cell area measurement which is a result of variations of shadow masking during cathode deposition. This comparison of device parameters between the two test systems gives us confidence in our internal efficiency measurements. Figure 9 shows NREL-certified data for I-V (left), and the EQE spectrum of the highest certified OPV device, respectively. The efficiency of 5.4%, was the world-record for the highest OPV lab-cell efficiency measured at that time.

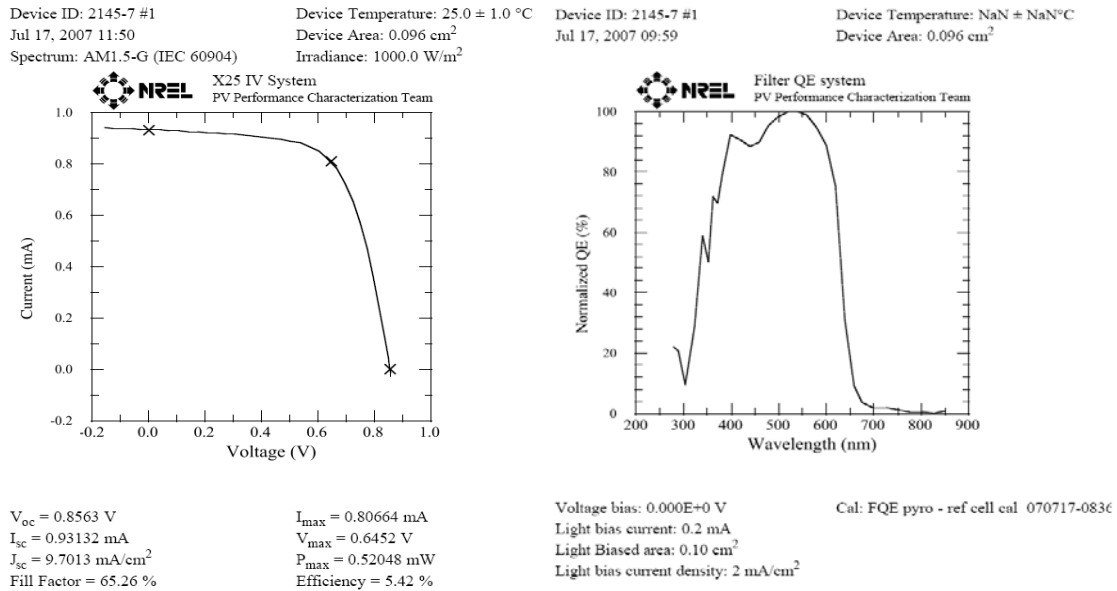

Figure 9: I-V data of OPV device certified to 5.4% at NREL (left) and Normalized EQE spectrum from NREL (right)

MILESTONE #6: Report on Design and Fabrication of Pre-Production Prototype Module.

KEY METRICS: Efficiency (active area) = 1% (internally tested).

This report was a summary of the module modeling efforts between Plextronics and our consultant, Dr. Sean Shaheen from University of Denver.

6.1 General Modeling Methodology

The module modeling effort was being carried out as three components: a “back end” consisting of differential equations that solve for the series resistance of the individual devices as a function of their size and shape, a “front end” consisting of assembly of the complete module circuit layout and subsequent generation of $J-V$ and power conversion efficiency characteristics, and an interface that will allow for simple input of module layout. At this time, the front end was complete, and was being used to test various scenarios of module design, especially with regards to the effects of variance in the individual device parameters, as discussed below. Work on the back end was underway. Figure 10 outlines the strategy.

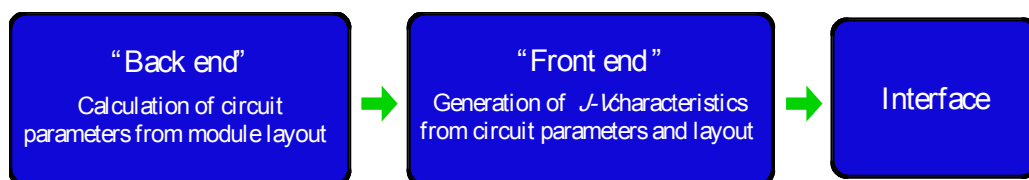

Figure 10: Flow-chart of the module modeling effort

6.2 Module Performance and Analysis

Plextronics has fabricated a $150\text{mm} \times 150\text{mm}$ module with 108 cm^2 of active area to achieve 1.07% efficiency under large format AM1.5 (78 mW/cm^2 , KG-5 Si reference) solar simulation. This configuration was a first attempt at designing an OPV module based on spin-coating, in essence it is a scaled version of our prototype devices but with 2 cm^2 individual pixels. There are 54 individual pixels all connected in series thus allowing for a high voltage module. The current champion data (efficiency of 1.07%) are shown in Figure 11 as well as modeling fits on earlier device data (0.9%) which was studied as a basis for this modeling work.

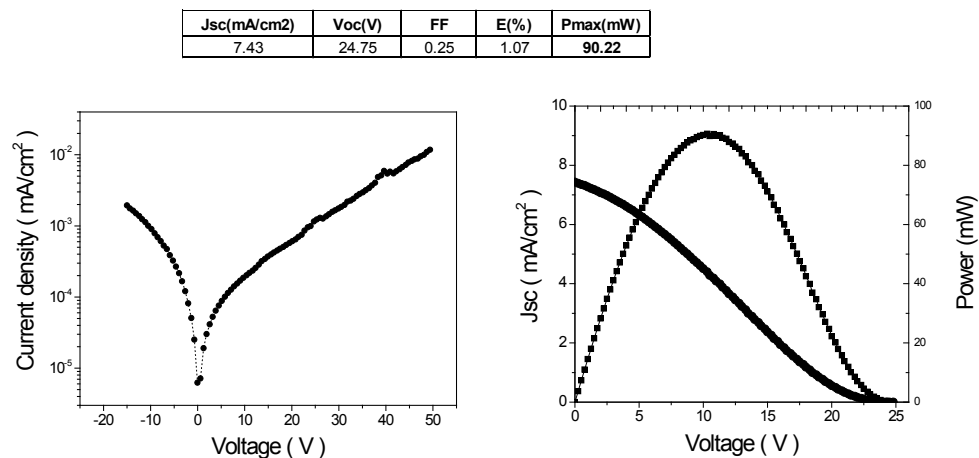

Figure 11: OPV Module performance

The circuit model used for each individual device on the module is shown in Figure 12 (left). Fitting of the simulation to preliminary data of a module consisting of 54 devices in series (hereafter referred to as

54S) was also performed and is shown in Figure 12 (right). This particular module data exhibited very poor $J-V$ characteristics. A “reverse curvature” can be seen for the $J-V$ curve within quadrant IV. This can often be explained by a poor interface between the top metal electrode and the organic active layer in OPV devices.

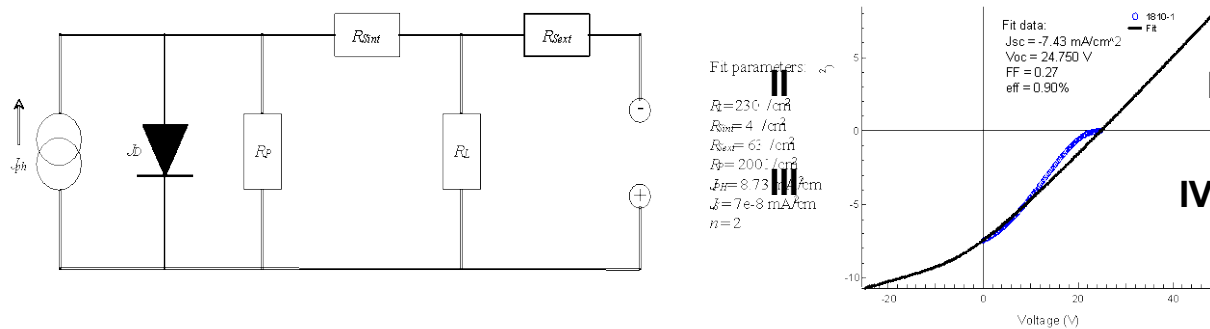

Figure 12: Equivalent circuit of the individual cell (left) and fitting of simulation to actual data.

MILESTONE #7: Report and Update on LCOE of OPV Module.

This report documented the improvements made over the last quarter in order to increase the sophistication of Plextronics' OPV LCOE model. Most of the modeling improvements were made in the module cost modeling that drives the LCOE calculation with some additional refinement in the projections for module lifetime, degradation and efficiency. Figure 13 outlines the various factors that contributed to the LCOE modeling effort during this quarter.

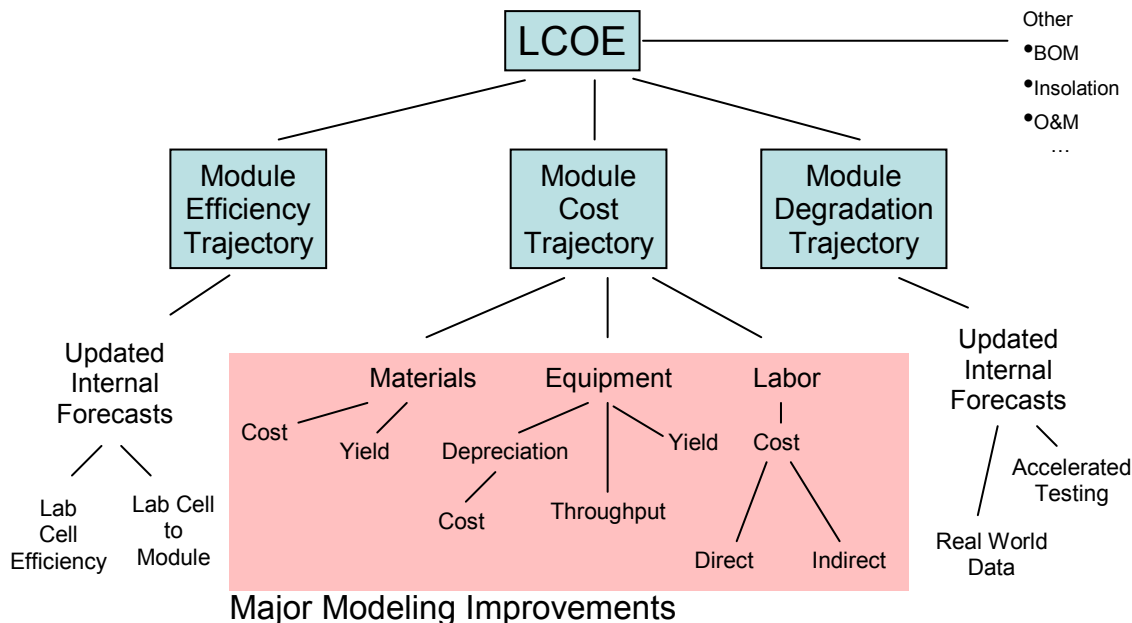

Figure 13: Factors contributing to LCOE modeling effort

In addition to simply calculating the cost trajectory, the model also provides a number of features to allow it to be used for process analysis and optimization. One particularly useful feature of the model is the ability to automatically calculate a number of key metrics for the manufacturing process. The total megawatt output of the plant, the total capital expenditure, the capital expenditure per unit output, the cost per watt, and, as mentioned above, the cost per meter squared are all calculated on a year by year basis. These extend the model's use to include strategic planning as it is now possible to compare different manufacturing processes on the basis of not only LCOE, but capital investment, manufacturing scale as well a number of other dimensions.

Taken together, Plextronics' LCOE and manufacturing models provide the ability to explore a wide spectrum of manufacturing options and their effects on LCOE. The strength of the model lies in its ability to quantify the sensitivity of LCOE to its many constituent inputs. From exploring simple materials substitutions to complete process shifts, the model's flexibility and comparative functionality allows for rapid iteration and quantification of different process flows. This can be used to rapidly identify key technology drivers for LCOE reduction. Through the use of the models, we have explored a number of materials and equipment choices, identifying key cost drivers and possible process technology improvements that would lead to significant cost reductions.

MILESTONE #8: Quarterly Report.

As a part of this report, Plextronics gave an update on our OPV lab-cell and module performance as well as an update on our device lifetime and stability measurement program.

8.1 Lab-cell update

We reported on our improved materials development effort that led to an internally measured efficiency of 6.1% (See Figure 14).

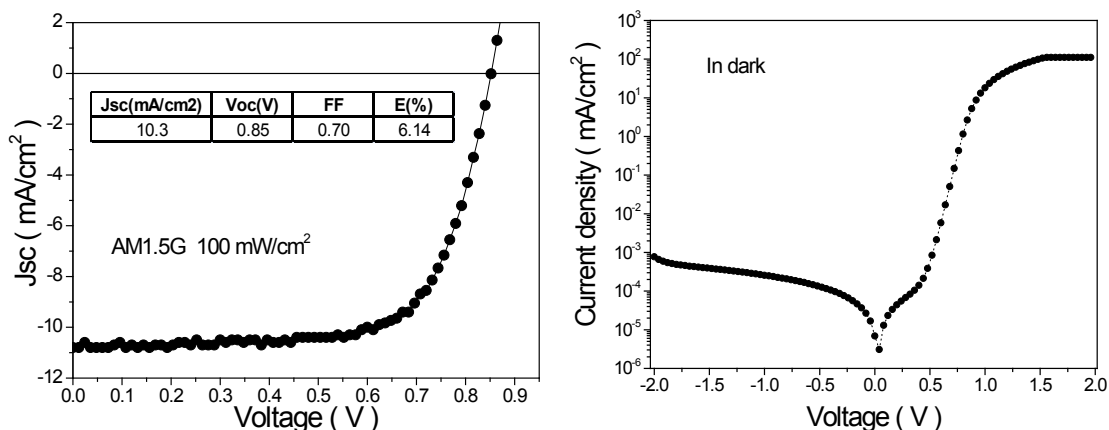

Figure 14: J-V characteristics of device under AM1.5G (left) and in dark (right)

8.2 Module update

We redesigned the layout of the OPV module in order to mitigate impact of observed non-uniformities along the periphery of the 150mm × 150mm glass substrates. These non-uniformities in layer thickness are caused by air and or nitrogen turbulence during the spinning operations. This helped to improved efficiency of the module from what was previously reported (see Figure 11). It should be noted that despite suppressing the effect of the non-uniformities of coated films on module performance, they still affect performance of several cells, namely those located near the corners of the substrate. We proposed to alter the spinning equipment in order to eliminate the presence of weak cells caused by non-uniformities of the organic layers. Figure 15 shows the efficiency data, measured internally at 1.88%, for the redesigned module.

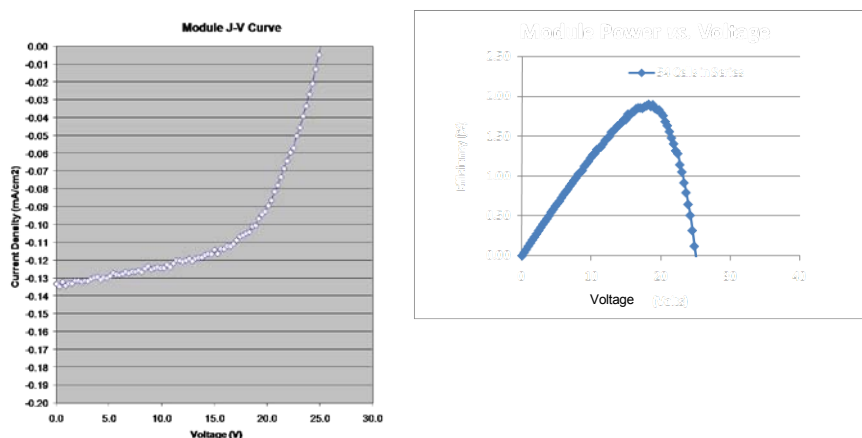

Figure 15: J-V and Power-Voltage data of 150mm × 150mm OPV module; Intensity = 100 mW/cm²

8.3. Update on Plextronics' OPV lifetime program

8.3.1 Facilities upgrades

During this quarter, we made a significant addition to our OPV lifetime testing facilities, both indoor and outdoor setups. This included installation of a high intensity Xenon lamp to better simulate the solar spectrum; a temperature and humidity oven to simulate outdoor conditions and a compact, 32 device holder for lifetime testing. Furthermore, 36 additional holders were added for outdoor testing. We also placed an order for 10 channel all-weather lifetime tester and a photocurrent mapping instrument to carry out degradation studies on aged OPV devices.

8.3.2 Device lifetime

Outdoor rooftop testing of devices started at Plextronics rooftop in June 2007. As per Plextronics defined stabilized lifetime, these devices are performing very well with their stabilized power/efficiency still above T80. Some of the devices have shown to retain over 3% efficiency for >7000 hours. Figure 16 and Figure 17 show the un-accelerated roof-top lifetime data for devices made using P3HT:PCBM and proprietary active layer materials, respectively. Linear extrapolation of the decay curves project the lifetime to cross beyond 13000 hours.

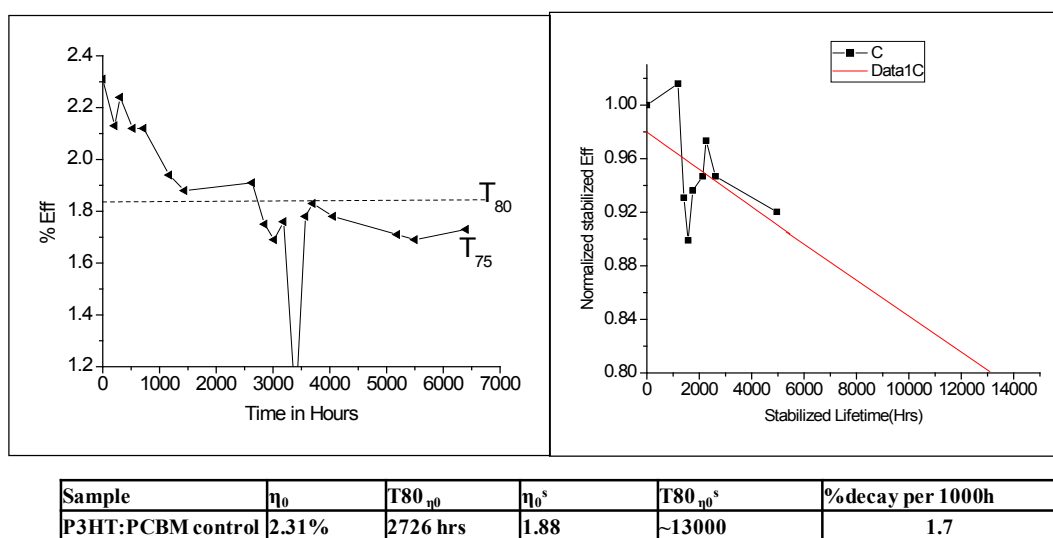

Figure 16: Un-accelerated roof-top outdoor lifetime data for P3HT:PCBM

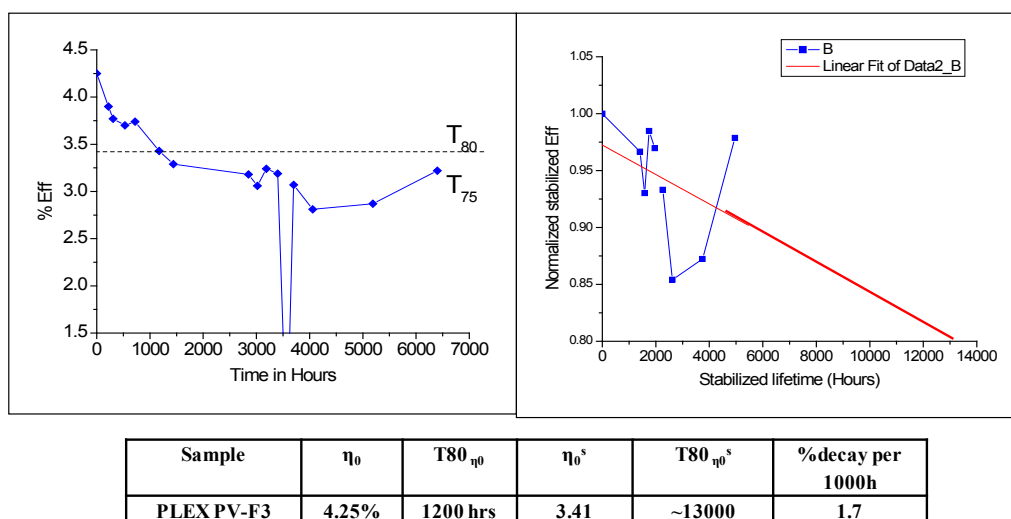

Figure 17: Un-accelerated roof-top outdoor lifetime data for proprietary active layer materials

MILESTONE #9: Report on Prototype Manufacturing.

This report documented the design of Plextronics prototype manufacturing development line (D-Line), including design options, vendor identification, and capital analysis. The D-line, is intended to be a learning tool for Plextronics through which we plan to translate our lab-scale OPV technology to large area (150mm × 150mm) modules, utilizing manufacturing worthy processes.

The D-line has been designed with focus on key areas within Plextronics process flow for OPV device fabrication using 150mm × 150mm modules. They are:

1. Module Design/Cell Architecture:
 - Establish in-house patterning capability to enable faster substrate design iteration that drives increased module efficiency. This leads to greater module power output and results in overall lower cost.
2. Organic Layer Application:
 - Evaluate solution processes that, in comparison to spin coating, have higher materials utilization, improved cycle (TAC) time, and are scalable to larger panel sizes (370mm × 470mm and larger). This ultimately enables low-cost manufacturing.
3. Cathode Deposition:
 - Evaluate commercial scale PVD (thermal evaporation) equipment capable of operating in a continuous manner, as well as having the capability of running processes in parallel. This too results in low-cost manufacturing.
 - Investigate alternate PVD processes such as sputtering and e-beam evaporation that have the potential for faster TAC time and/or are scalable to large panel sizes (370mm × 470mm and larger).
4. Encapsulation:
 - Set-up a system capable of encapsulating 150mm × 150mm modules. Investigate methods of encapsulation that help prevent the degradation mechanisms of OPV device.

The areas of focus for the Pilot line and where they align with the process flow is shown in Figure 18.

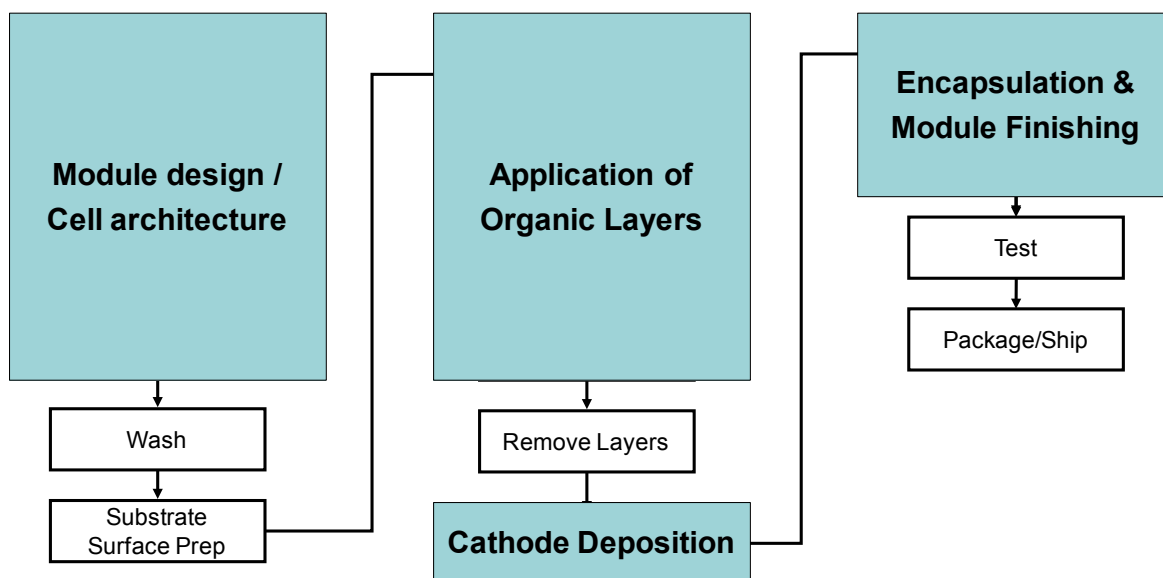

Figure 18: Pilot Line: Technology Development Focus

MILESTONE #10: Report on Lab-Cell Performance.

KEY METRICS: Lifetime > 3723 hours.

10.1 Device Design

Figure 19 shows the design of Plextronics organic solar cell on 50mm × 50mm glass substrate, viewing from the back side. The red lines indicate the ITO patterns on the glass substrate with long and short rectangles as anode and cathode leads, respectively. The red words and number indicate the information about the design and the order of 4 sides. 4 grey “L” shapes indicate the open area of shadow mask for cathode deposition. The square (black line) at the center of substrate indicates the cover glass for encapsulation. All active material on ITO outside of the central square needs to be removed by the laser ablator. As results, the overlap area of grey (cathode) and ITO inside the square produce a 3mm × 3mm active area of cells on each side of substrate. And the overlap of grey and ITO outside of cover glass is to secure the contact between ITO and cathode metal evaporated.

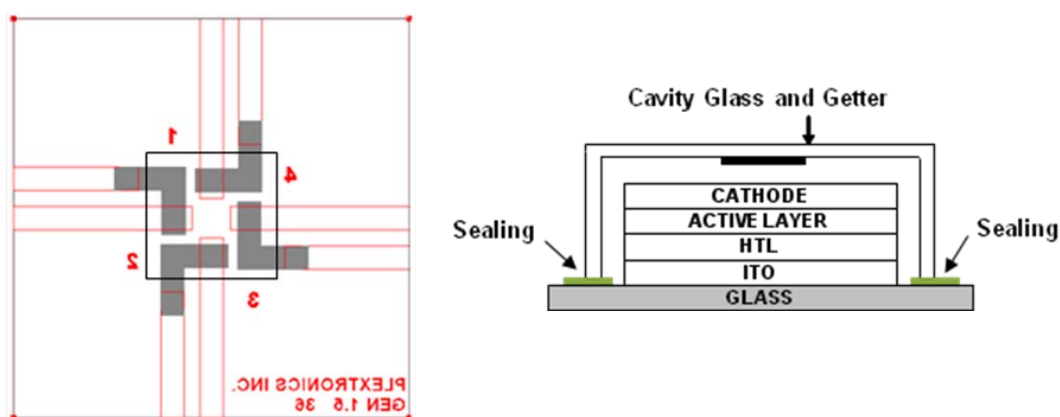

Figure 19: (left) Back side view of the design of Plextronics organic solar cells on 50mm × 50mm glass substrate. (right): Vertical structure of solar cell devices.

10.2 Accelerated 1 Suns/30°C continuous testing

A Xenon lamp (Atlas Specialty Lighting, PE240E-13FM) was used to generate both the temperature and light. The output designation of ‘1Suns’ is derived from adjusting the intensity of light falling on the devices to be such that a KG-5 cell placed in the same fixture would generate the same current it generates under standard AM 1.5G testing. The devices were connected to a data acquisition setup where an adjustable DC load maintains them at their maximum power point (MPP). The power output of the cells was continuously monitored over time. In addition, intermittent monitoring of the PV parameters such as Voc, FF, Jsc were performed. Note that an acceleration factor has not been determined for this system.

Figure 20 (left) illustrates the output power of a lab-cell device that changes with time under ~1 sun Xe-lamp amp. The encapsulated devices were tested in ambient conditions with 100% duty cycle. The temperature of substrate was controlled at ~30°C. From this plot, the data can be divided into two distinct ranges. The first range is from 0 to about 450 hours and the devices shows quicker degradation in this range. After the initial degradation, the device starts to degrade slowly and stabilizes from ~500 hours. The data in stabilized range will be used to extrapolate the life time. Figure 20 (right) shows the normalized power output (based on the starting point of stabilized range) change with post-stabilized exposure time. The red dot line indicates the reference of 80% of initial stabilized power output of device. The stabilized data point was linearly fitted with black solid line. The crossed point of the black solid line and red dot line indicate a 2800 h life time for this particular device. It is called as the lifetime of T80 stabilized. The milestone requires 3723 hours lifetime of lab-cell devices under 1sun with 50% duty cycle. Since our device (demonstrating 2800 hours T80 stabilized) was tested under 1sun but 100% duty cycle, translation to 50% duty cycle could be 5600 hours. A multiplier of 2 was used for this simple translation

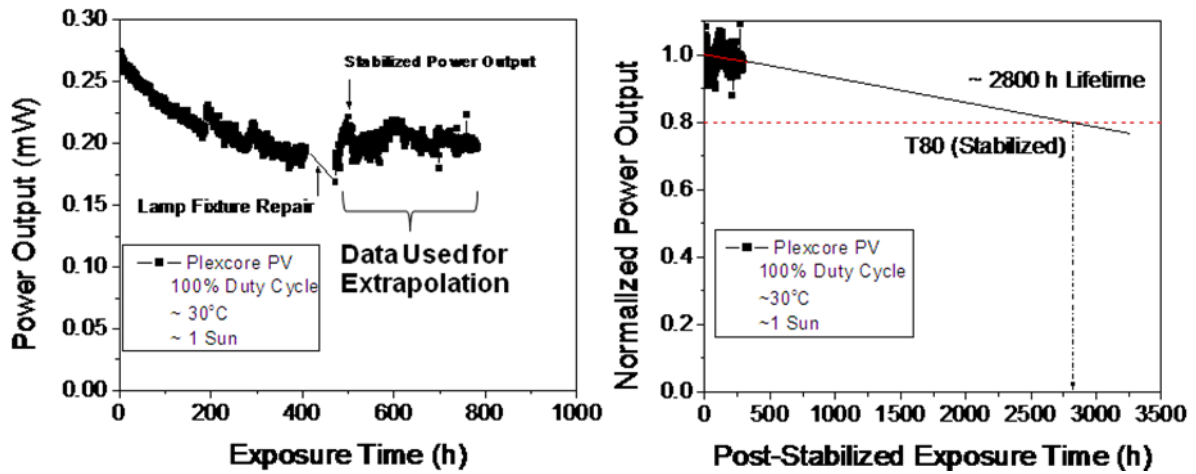

Figure 20:(left): The output power of a device under ~1sun changes with time. The temperature of the substrate was controlled at ~30°C; (right): Normalized output power changes with time after the output power stabilized

MILESTONE #11: Report and Update on LCOE of OPV Module.

In this quarter, Plextronics further strengthened the connection between manufacturing choices and the impact on LCOE by allowing each defined process flow to include its own efficiency and lifetime, recognizing that process and materials choices may and, in many cases, will impact module performance. In addition to this significant change, several model inputs were refined and the LCOE model expanded, to include competing technologies such as α -Si, CdTe, c-Si, and CIGS to provide a baseline that relies on the same calculation methodology for comparison purposes. The report explained the changes, including examples of the calculations that these changes enable, and in doing so, demonstrated the results of these changes on the calculated LCOE for OPV.

11.1 Linking Processing and Performance to Drive LCOE

Plextronics' LCOE model was expanded to mirror the concept of simultaneously tracking individual process flows introduced in the manufacturing cost model as part of milestone #7. Rather than looking at a single process, the LCOE model now included ten separate processes as well as entries for competing technologies. Previously, the LCOE model included process independent efficiency and lifetime trajectories while the module cost depended on the process flow and was calculated using the manufacturing cost model, as shown in Figure 21. This approach ignores the intimate connection between the choice of processing methods and the final performance of the device.

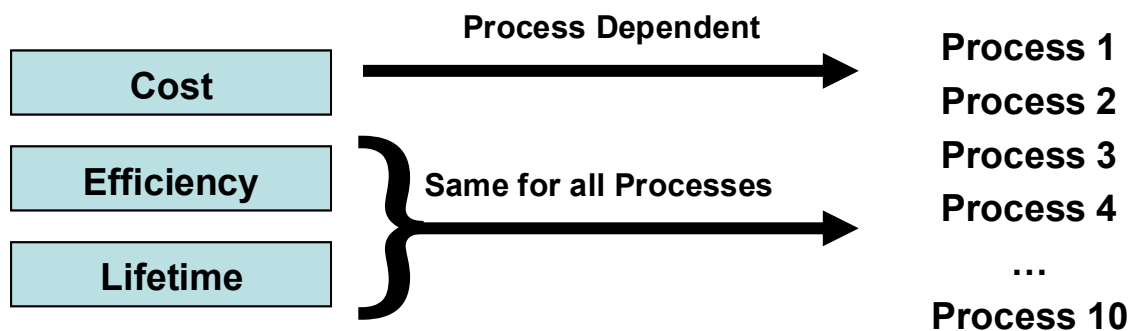

Figure 21: Previous LCOE Model Handling of Cost, Lifetime, and Efficiency Trajectories

To establish this connection, the methodology used in the model was changed to reflect the dependence of cost and performance on process and materials. As shown in Figure 22, the LCOE model has been modified such that the lifetime and efficiency trajectories are now associated with a given process and tracked independently. The result is a tool that yields a better understanding of the impact of module manufacturing choices on LCOE.

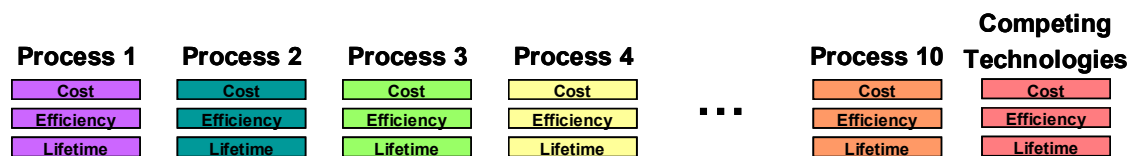

Figure 22: New LCOE Model Handling of Cost, Lifetime, and Efficiency Trajectories

MILESTONE #12: Prototype Gen1 Module Performance.

KEY METRICS: Efficiency (active area) = 1.5% (NREL-certified); Lifetime = 2000 hours (80% of initial stabilized efficiency under ~ 1 Sun and at 50% duty cycle).

Plextronics 150mm × 150mm OPV module consists of 54 identical cells (1 cm × 2 cm) that are organized in six parallel columns; each column contains 9 cells connected in series. The columns are electrically isolated so they can be measured independently and also allow various module configurations. The final configuration is achieved by external wiring; we chose, for development purposes, to connect either all columns in series (54s) or in a series/parallel (9s6p) configuration. The reported results in this report are for (54s) configuration.

12.1 Module Efficiency

Figure 23 shows the performance of the OPV Module certificated at NREL as exhibiting 1.1% total area efficiency. This module was made from P3HT and PCBM blend and demonstrated 2.3% power conversion efficiency based on actual (47% total coverage) active area ($1.1/0.47 = 2.3$).

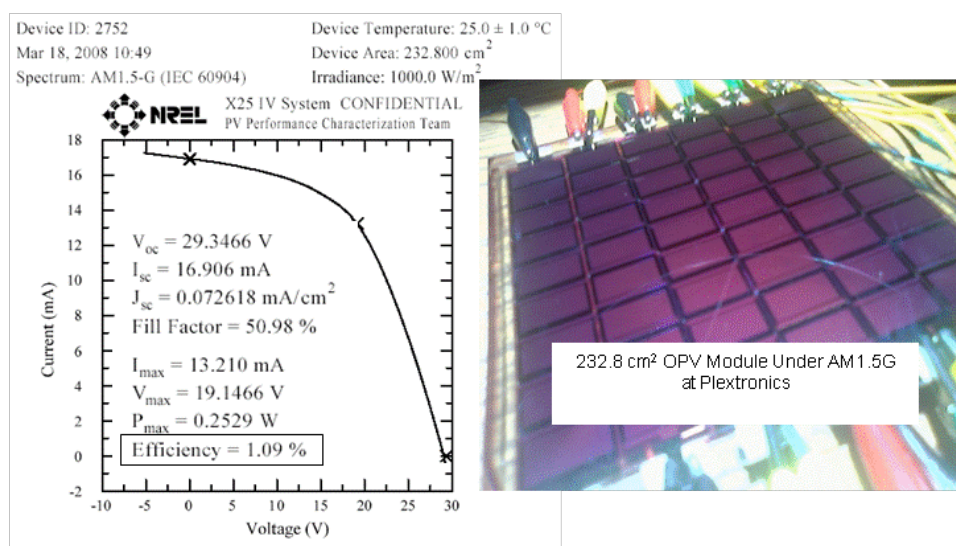

Figure 23 (left): I-V curves of recent module certification at NREL; (Right): Module with testing leads

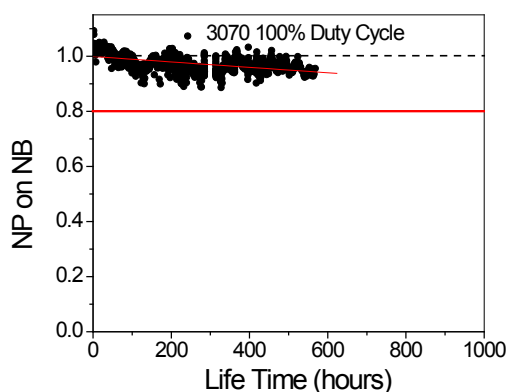

Figure 24: The normalized output power of the module based the decay of Xe-lamp illumination illustrating ~ 9.82%/1000h decay rate at 100% duty cycle translating to > 4000h of lifetime to T80 at 50% duty cycle with ~ 1 sun illumination.

12.2 Module Lifetime

The lifetime testing of modules was carried out under a large-area, high-intensity Xe-lamp. The illumination intensity was tracked while the devices were placed on a temperature-controlled stage, with an adjustable DC load maintaining the devices at their maximum power point.

Figure 24 shows the normalized output power of the module after 500 hours; normalized by the input power decay of Xe-lamp irradiation. The increased scattering of normalized data is due to variations in the output of the Si photodiode and the module magnified by the normalization process. Application of a linear fit to the data gives a decay rate of 9.82% per 1000 hours (so the decay rate is ~5% per 1000 hours for 50% duty cycle). The lifetime is therefore greater than 4000 hours based on Plextronics' definition.

Figure 25 shows the change of J-V characteristics (AM1.5G solar simulation) of the module after being illuminated under ~ 1 Sun Xe-lamp for 550 hours. The module performance is essentially unchanged, within the variation of test error, typically $\pm 3\%$, strongly indicating that the module performance is very stable. The FF increased with light soaking, with a slight decrease in J_{SC} and V_{OC} . This led to essentially no significant change in the max power output (158 vs 153 mW).

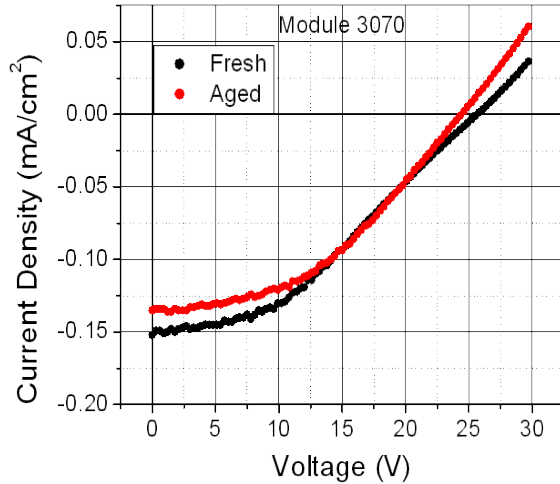

| Parameters | Initial | at 550 h |
|--------------------------------|---------|----------|
| J_{sc} (mA/cm ²) | 0.15 | 0.14 |
| V_{oc} (V) | 25.50 | 24.30 |
| FF | 0.37 | 0.43 |
| E (%) | 1.48 | 1.40 |
| P_{max} (mW) | 155.80 | 153.00 |

Figure 25(left): AM1.5G solar simulation J-V characteristics of module operated for 550 hours under ~ 1 Sun Xe-lamp, black-Freshly fabricated device; Red- 550 hours aged device. Spectral mismatch was applied to these efficiency measurements to correct the photocurrent; (right): Change in module parameters

MILESTONE #13: Stage-Gate Review.

In July 2008, Plextronics underwent a stage-gate review for Phase I of the PV-Incubator project. We reported on all the deliverables which we met on schedule, or in most cases, well before the deadline. We presented our outlook for the Phase II of the program, as well as the long-term success of OPVs, including a pathway for commercial on-grids markets.

MILESTONE #14: Quarterly Report.

14.1 Update on Efficiency

We provided an update on both, lab-cell and module efficiency. Figure 26 shows the data for lab-cell efficiency, internally measured at 6.32%.

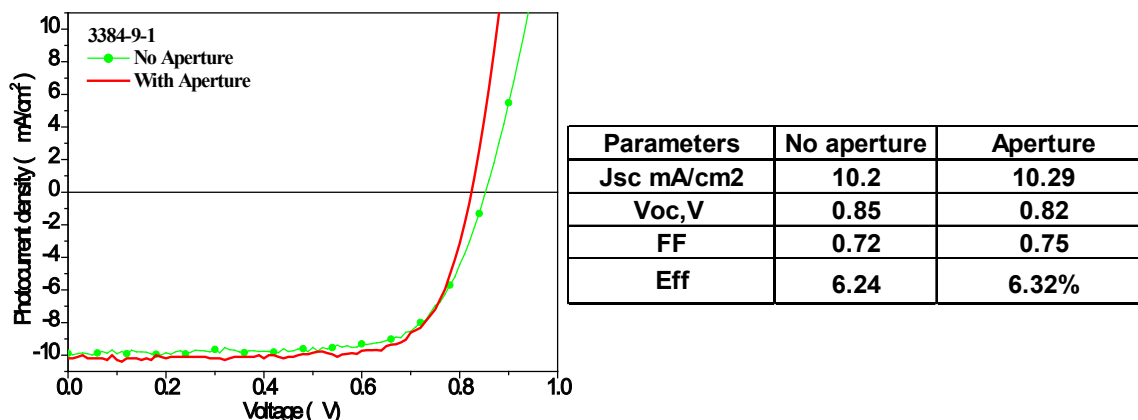

Figure 26: J-V data of lab cell OPV device tested internally, with and without aperture

Figure 27 shows the data for 150mm × 150mm module certified at NREL as exhibiting a total area efficiency of 1.56% (active area efficiency of 3.23%).

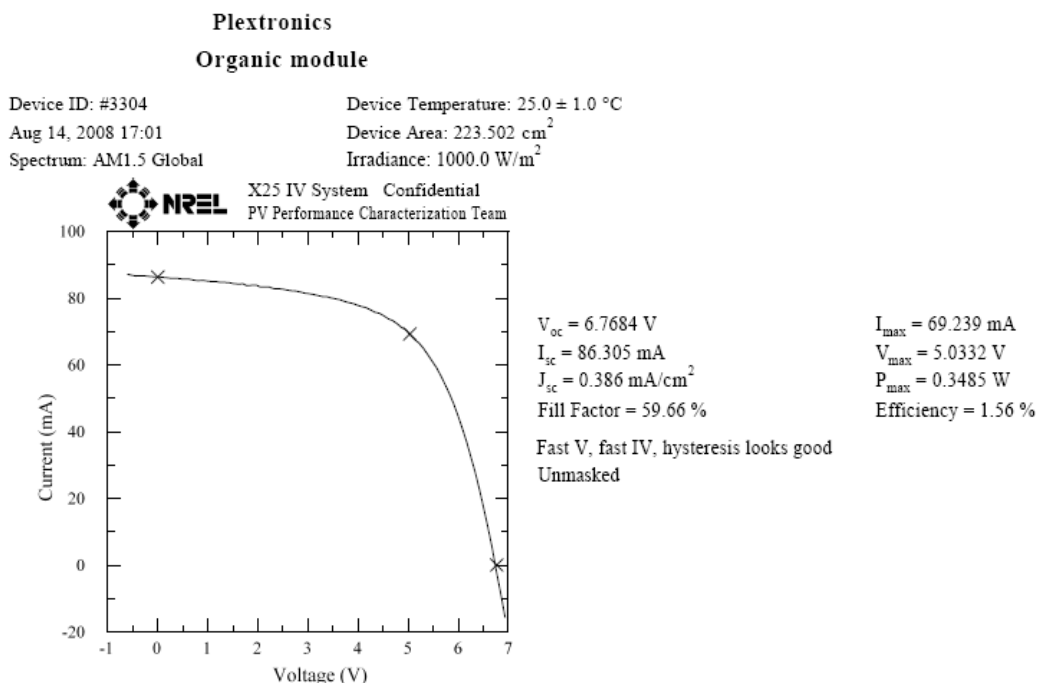

Figure 27: J-V curve and performance data (certified by NREL) of 150 mm x 150 mm OPV module

14.2 Update on Lifetime

We provided an update on the stability of Module 3070 (data first discussed in Milestone #12, Figure 24). Figure 28 (left) shows the normalized output power of Plextronics' module (3070) after being normalized by the input power decay of Xe-lamp irradiation. The increased scattering of normalized data is due to stochastic variations in the lamp intensity, while the red arrow indicates the inflection of the power output

due to the module position change after JV measurement. Application of a linear fit to the data gives a decay rate of 9.82% per 1000 hours (the decay rate is ~5% per 1000 hours for 50% duty cycle). *The decay rate observed would correspond to a lifetime of 5000 hours, measured with an initial efficiency of 1.48%.* Figure 28 (right) shows the change of J-V characteristics (AM1.5G solar simulation) of Plextronics' module (3070) after being illuminated under ~1 Sun Xe-lamp for 648 and 1320 hours. The module performance is essentially unchanged, typically +/- 3%, within the variation of test error, and indicates that the module is very stable.

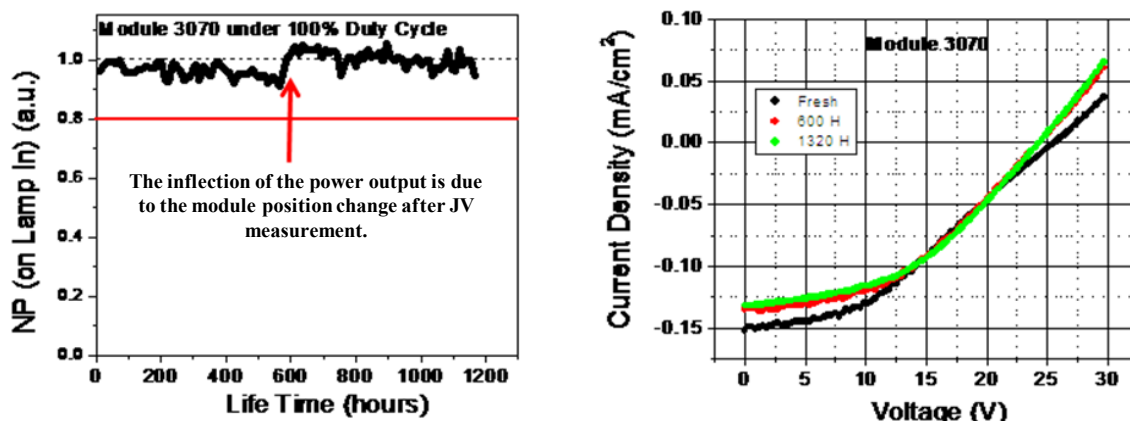

Figure 28(left): Normalized power output of module 3070 under Xe-lamp. This decay rate translates to > 5000h of lifetime to T80 at 50% duty cycle with ~1 sun illumination. (right): AM1.5G solar simulation J-V characteristics of module 3070 operated for 648 and 1320 hours under ~1 Sun Xe-lamp. Data were smoothed (reduction of data points and removing of outliers) by interpolation in Origin software.

14.3 Update on work with University consultants

14.3.1 Arizona State University

We have been working with its consultants at the Flexible Display Center (FDC) at Arizona State University (ASU), to develop a spray coat method for organic layer deposition in OPV fabrication. During the spray coating process the substrate rotates at low angular velocity while the swivel arm of the spray coating unit is moved across the wafer. The dynamics of the process is shown as a schematic drawing in Figure 29. ASU will study the effect of different parameters such as solid content, solution dispense rate, scanning speed of atomizer, spin speed of substrate and spray pressure in the spray process, on the film properties such as film thickness, uniformity and roughness. The performance would be compared to an OPV device prepared by spin coating.

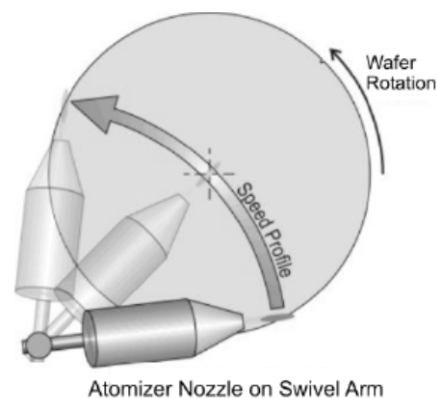

Figure 29: Schematic drawing of the dynamics in spray coating process

ASU has optimized the spray coat process parameters on glass for Plextronics' Plexcore[®] OC HTL material. The AFM data of surface roughness for spray coated HTL film on glass at different solvent dilution ratios is shown in Figure 30. Spray coated HTL film of thickness around 50 nm with root mean square surface roughness around 4nm and thickness non-uniformity of 12% was achieved.

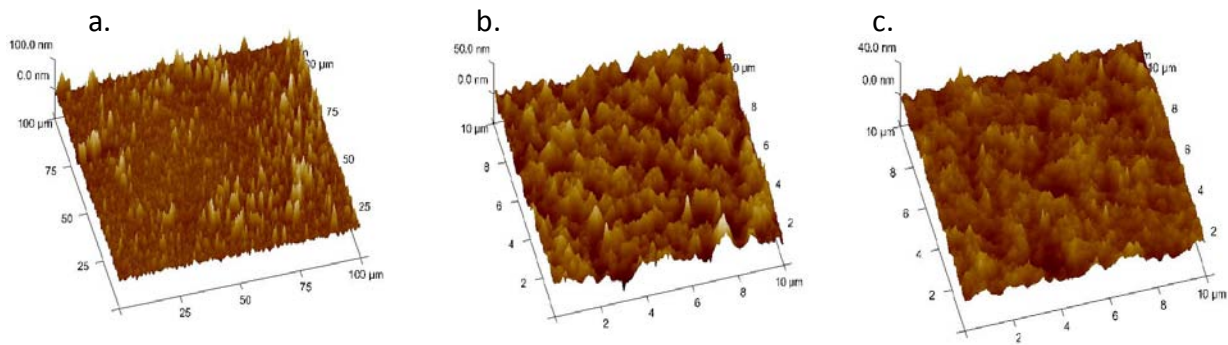

Figure 30: AFM profile of sprayed HIL film with thickness around 50nm at different dilution ratio (a) HIL:MeOH=1:5, R(rms)= 11nm, R(peak to valley)= 128nm, (b) HIL:MeOH:IPA=1:4:1, R(rms)= 7nm, R(peak to valley)= 74nm, (c) HIL:MeOH:H₂O=1:0.5:3.5, R(rms)= 4nm, R(peak to valley)= 36nm.

ASU also worked on optimizing the spray coat process parameters on glass for OPV active layer material from Plextronics. The spray coated film of OPV active material dissolved in mixture of solvents ‘A’ and ‘B’ showed very high surface roughness. Mixing the solution with solvent ‘C’ further deteriorated the surface roughness, necessitating the investigation of some other solvent systems. OPV active material dissolved in alternate aromatic solvent ‘D’ gave better surface roughness. But as compared to solvent ‘B’ (21.8mm Hg vapor pressure at 20 °C), this solvent has very low volatility (0.18mm Hg vapor pressure at 20 °C) and there was too much flow of material. If flow rate is increased or multi-pass is used instead of single pass to achieve the target thickness of 200nm, the material flowed towards the edge. A modified formulation with OPV active material dissolved in a mixture of the alternate aromatic solvent and solvent ‘B’ may help achieve the desired thickness and surface roughness. The AFM data of surface roughness for OPV active material with different solvent mixtures are shown in Figure 31.

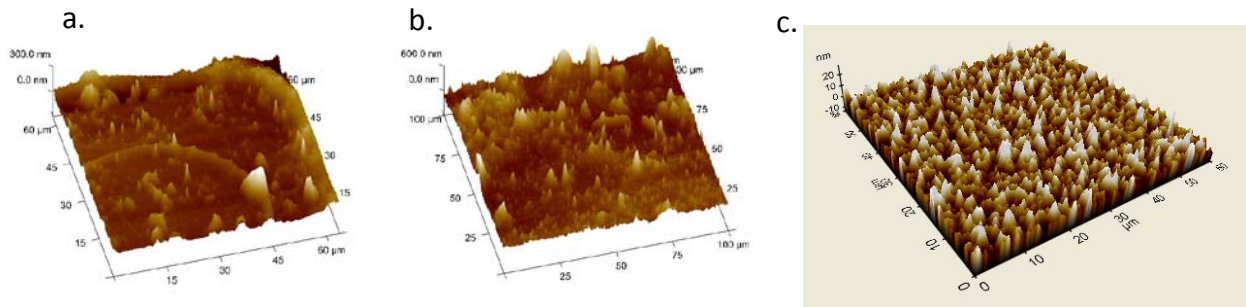

Figure 31: AFM profile of spray coated OPV active material for different solvent mixture (a) A:B=1:2, R(rms)= 45nm, (b) A:B:C=1:2:1, R(rms)= 87nm, (c) D:B =1:1, R(rms)= 4nm.

14.3.2 University of Denver

Plextronics’ consultant, Prof. Sean Shaheen at University of Denver, worked on a model to identify the most robust module configuration against shorted cells. This includes simulating performance of modules having 54 identical cells, each having an active area of 1cm × 2cm, and organized in six parallel columns, each containing nine cells that are configured differently (see Figure 32).

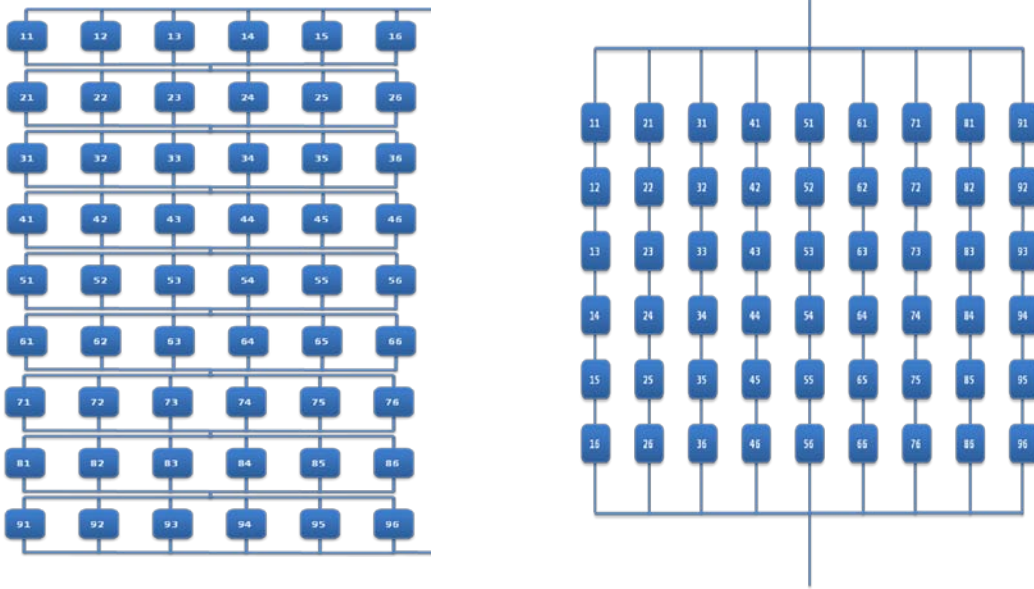

Figure 32: Module cells connected in different configurations

It was observed that with a full series configuration, there is a decrease in all device parameters with 9 shorted cells in the module. Change in module configuration to a columnar design with parallel components does not lead to significant decrease in either of the device parameters, especially the current density. It was thus concluded that the consequences of shorted (weak) cells on module performance can be modestly mitigated by internal wiring configurations, but general improvements for any configuration can only come from identification and removal of the causes for the underperforming cells.

MILESTONE #15: Quarterly Report.

15.1 Module Development

We reported on module efficiency and lifetime data – discussed in detail in Milestone #18 and #19, respectively).

15.2 Plextronics Testing Facility Update

During this quarter we added a Q-Sun testing unit for accelerated degradation studies on lab-cells and modules. The unit (See picture in Figure 33) which has 3 Xe-lamps built-in for large area uniform intensity is equipped with the Solar Eye Irradiance Control System. The solar eye automatically compensates for lamp aging and any other intensity variability. The light intensity can be controlled from 0.2 to 1.5 sun (300 to 3000 nm) by specifying the intensity of total UV. The relative humidity can be controlled from 10% to 85%, while varying the temperature from 25 °C to 100 °C. The large sample tray (17.75 in × 28.25 in) will allow several devices and modules to be tested simultaneously. We initiated test on devices with the help of this setup which will allow unique control over light, humidity and temperature. We are measuring the irradiance output within this test unit, humidity, as well as device surface temperatures to better understand the actual device testing conditions with this unit.



Figure 33: Q-Sun Testing Unit

15.3 Plextronics' OPV Manufacturing Development Line (D-Line)

On January 27th 2009, we hosted a ribbon-cutting ceremony to celebrate the opening of the company's first manufacturing development line (D-Line) (see Figure 34). We intend to use this facility to print solar demonstration modules for the purpose of developing our printable solar inks using commercially relevant manufacturing techniques. The knowledge gained will be beneficial in pushing the performance of OPVs towards commercially relevant metrics, especially the goal of achieving grid-competitiveness by 2015. We have installed and have made operational several pieces of equipment and processes on the D-Line in areas such as: (1) Substrate cleaning and surface preparation, (2) Organic layer application, (3) Organic removal, (4) Cathode deposition, and (5) Encapsulation.

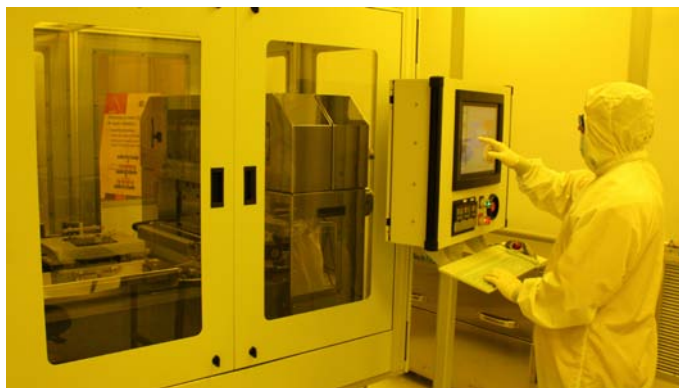

Figure 34: Plextronics' state-of-the-art D-Line

MILESTONE #16: Deliver A Lab-Cell Sample.

KEY METRICS: Efficiency = 5.8% (NREL-certified).

Plextronics has demonstrated NREL-certified efficiencies of 5.98% utilizing proprietary Plexcore[®] materials. The open-circuit voltage was measured at 0.8079V and a high fill factor of 71.67%. Figure 35 shows NREL-certified data for I-V (left) and the EQE spectrum (right) of the, respectively. At the time of the measurement, this was the highest NREL-certified OPV lab-cell.

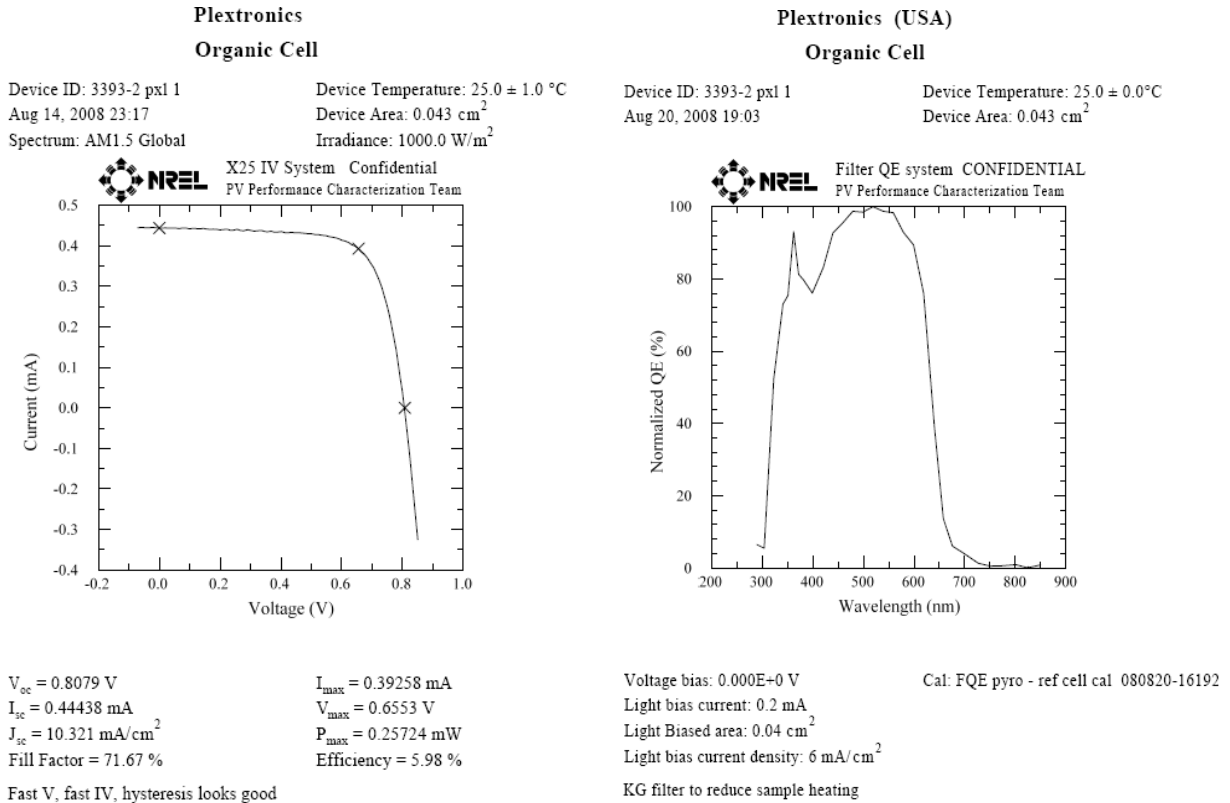

Figure 35 (left): I-V data of OPV device certified to 5.98% at NREL; (right): Normalized EQE spectrum

MILESTONE #17: Lab-Cell Lifetime.

KEY METRICS: Lifetime = 5,776 hours to > 80% of its stabilized performance under 1 sun with 50% duty cycle.

17.1 Lifetime testing of OPV Lab-Cell

Figure 36 (left) shows the normalized efficiency performance of the champion lab-cell exposed to the Xe-lamp as a function of time. The decay rate (8.25%/kh) was extracted by removing the burn-in range and the T80 of 4848 hours was calculated based on our definition of OPV lifetime. Figure 36 (right) shows the corresponding J-V characteristics at the four different sampling times.

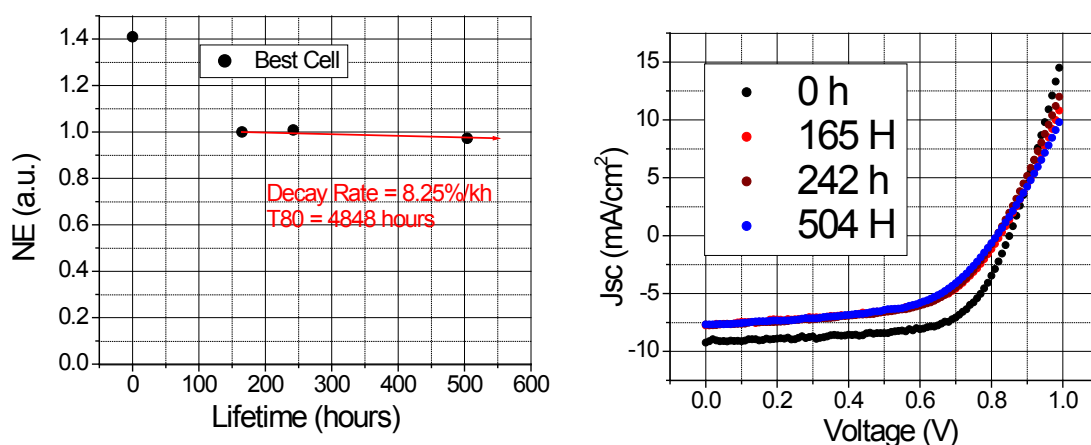

Figure 36(left): Efficiency performance of champion lab-cell over 500 hours of light soaking; **(right):** J-V characteristics of the lab-cell

17.2 Modification in OPV Lifetime Definition and Analysis

OPV lifetime is currently defined as the amount of time that an OPV cell, sub-module, or module diminishes to 80% (T80) of its initial ‘stabilized’ power output (or power conversion efficiency) and normalized by the illumination intensity (accounting for lamp variations and spectral mismatch). The illumination intensity is measured as ~1 Sun simulated by a Xenon arc lamp with (or converted to) 50% duty cycle.

In this definition, a factor of two (2) was applied to data taken at 100% duty cycle, to simulate a day-night cycle of 50%. In actuality, the day-night cycle represents significantly less than 50% integrated illumination after accounting for total energy exposure that the lab cells receive. In this assumption, the intensity variation that occurs daily and seasonally in the real world is not properly accounted for. To account for these real world variations, we compared the solar radiation (KWh/m²/day) that a flat-plate collector facing south at a fixed tilt receives in Phoenix, Arizona (AZ) and Pittsburgh, Pennsylvania (PA) monthly. According to a 30-year (1961-1990) average of monthly solar radiation at these two locations, the daily averaged solar radiation is about 6.5kWh/m² and 4.2kWh/m² in AZ and PA, respectively.¹ This value is consistent with the annual climatological data (8000mJ/m²/year at AZ) reported by Atlas (Atlas Material Testing Solution).²

Using a direct conversion from 1 sun (1000 W/m²) to kWh/m², the averaged incident intensity of our Xe-lamp was found to be 1.32kWh/m². Therefore, the daily irradiated power onto the devices under the Xe-lamp test setup is 1.32kWh/m²×24h = 31.7kWh/m². If we assume that the average solar radiation that a lab cell would receive at AZ (6.5kWh/m²) and PA(4.2kWh/m²) would approximate the average solar radiation that a device would receive in various locations in the United States and factor in the total

irradiance power that the OPV devices receive under a Xe-lamp at a 100% duty cycle (31.7 kWh/m^2), then we derive a conversion factor of 5.93 ($31.7 \text{ kWh/m}^2 / ((6.5 \text{ kWh/m}^2 + 4.2 \text{ kWh/m}^2) / 2)$).

By taking into account the conversion factor of 5.93 instead of 2, the T80 of the champion lab cell reported in Figure 36 is 14,362 hours (4848×3.0).

This re-calculation is based on the assumption that the performances of our devices are stable under no illumination (dark storage conditions). To verify that the OPV devices show no noticeable degradation during dark storage conditions, we compared the degradation of similar devices tested in the dark or placed under a Xe-lamp and irradiated at 1.32 suns. These results are summarized in Figure 37. The samples stored in dark showed no degradation over a time period of approximately 500 hours, and as a guide to the eye, a red dotted line is drawn at a normalized efficiency of one. In comparison, the devices irradiated under the Xe-lamp at 1.32 suns decayed to almost 60% of their original efficiencies (including burn-in). This suggests that the irradiance is one of the primary causes for degradation in OPV devices.

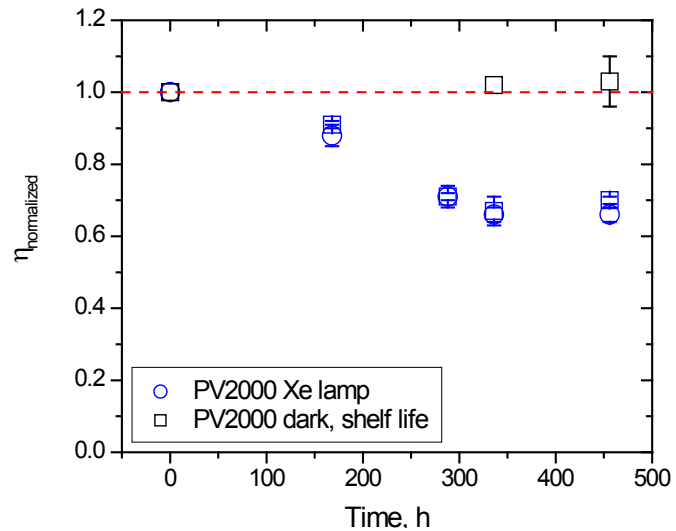

Figure 37: A comparison of the effect of light irradiance versus dark storage conditions on the degradation of OPV devices.

17.3 NREL-certification of Lab-Cells

Since the stability of the OPV devices has not been established or standardized, NREL requested the certification of lab cells before and after light soaking to better understand the degradation rates. In order to simulate the initial conditions of light stabilized devices, the following plan was implemented:

1. Age six (6) identical devices for 95 hours under the Xe-lamp to generate stabilized efficiencies.
2. Remove four (4) devices and place in the dark storage.
3. Age remaining 2 devices for 260 more hours. (A total 360 hours of Xe-lamp exposure); one with a shadow mask and one without
4. Ship all devices to NREL for certification

Since we had previously observed that degradation starts from the edge in our current mapping studies, we implemented a mask to minimize the edge degradation effects. Of the six devices made, three were aged under the Xe-lamp with a shadow mask containing a $1 \text{ mm} \times 2 \text{ mm}$ window. Of the four devices removed for dark storage, two of the devices were aged under the Xe-lamp with a mask and two were aged without a mask. These samples, their testing history and a summary of their performances are shown in Table 2. The lab cells that were not removed for dark storage do not have a T=95h efficiency measurement (Devices 4326-2 and 4326-3). Lab-cells that were removed for dark storage do have the associated efficiency measurement at T=95h to derive the light stabilized initial performance. Their average performance has been noted (Devices 4326-4/6, 4326-5/7, 4326-8/9). The final efficiency recorded after 360 hours of light soaking under the Xe-lamp or dark storage is indicated for all lab-cells. All the lab-cells that were tested with the shadow mask are noted (Devices 4326-2,4,6). After 360 hours light soaking, all devices were taken off the Xe-lamp and re-tested at Plextronics just prior to the shipment to NREL (labeled as 404 hours in Table 2)

The devices were tested at NREL and the results are included for comparison in Table 2 (the normalized E% of devices with different aging time is included below the actual measurements). From the shelf life devices, we can see the performance did not degrade (88% vs. 87%) during shipping from Plextronics to NREL. The NREL data of no Mask devices confirmed our previous conclusion that the device degraded about 10% (in green) during 265 hours post light soaking after being stabilized. The data from the devices with mask have 5% (in blue) degradation during 265 hours post light soaking probably due to the shift of masks position on the devices.

These results corroborate our claim that the irradiance is one of the primary causes for degradation in OPV devices. The efficiency measurement at NREL was done with a shadow mask which the size of window is about 0.023 cm². But the NREL used the different area to calculate the efficiency, so the correct factor ($A_{NREL}/0.023$) should be used to report the efficiency (shown in the last column of Table 2).

Table 2 (top): The averaged E% of the devices with different aging time; (bottom): the normalized E% of devices with different aging time. Includes Plextronics' and NREL measurements.

| ID | Mask | η (%) | | | | |
|---------------------|----------------|-------------|---------------------|-------------|-------------|-------------|
| | | Initial | 95h | 360h | 404 h | NREL |
| | | | Stablization | | | |
| 4326-2 | Mask | 4.92 | | 3.37 | 3.56 | 3.69 |
| 4326-3 | No Mask | 4.95 | | 3.86 | 3.26 | 3.22 |
| 4326-4/6 Ave | Mask | 5.05 | 3.54 | 3.93 | 4.02 | 3.99 |
| 4326-5/7 Ave | No Mask | 4.94 | 4.25 | 4.40 | 3.70 | 3.66 |
| 4326-8/9 Ave | Shelf | 4.86 | | | 4.28 | 4.18 |

| ID | Mask | Normalized η (%) | | | | |
|---------------------|----------------|------------------|---------------------|-------------|-------------|-------------|
| | | Initial | 95h | 360h | 404 h | NREL |
| | | | Stablization | | | |
| 4326-2 | Mask | 1.00 | | 0.68 | 0.72 | 0.75 |
| 4326-3 | No Mask | 1.00 | | 0.78 | 0.66 | 0.65 |
| 4326-4/6 Ave | Mask | 1.00 | 0.70 | 0.78 | 0.80 | 0.79 |
| 4326-5/7 Ave | No Mask | 1.00 | 0.86 | 0.89 | 0.75 | 0.74 |
| 4326-8/9 Ave | Shelf | 1.00 | | | 0.88 | 0.87 |

Mask
No Mask

References:

1. <http://rredc.nrel.gov/solar/pubs/redbook/>
2. http://www.atlas-mts.com/en/services/natural_weathering_testing/natural_weathering_testing_sites/arizona/climatological_data/index.shtml

MILESTONE #18: Deliver A Module.

KEY METRICS: (Active area) Efficiency = 3.5% (NREL-certified).

OPV Module Efficiency

Plextronics has demonstrated NREL-certified OPV module efficiencies of 1.96% and 2.05% (total area) that translate in 4.06% and 4.24% when re-calculated for Active Area (using Aperture Ratio of 0.4832). Figure 38 (a) and Figure 38 (b) shows NREL-certified data for Module 4100 and 4103, respectively, both having a 9S6P configuration (54 identical cells organized in 6 parallel columns of 9 cells each).

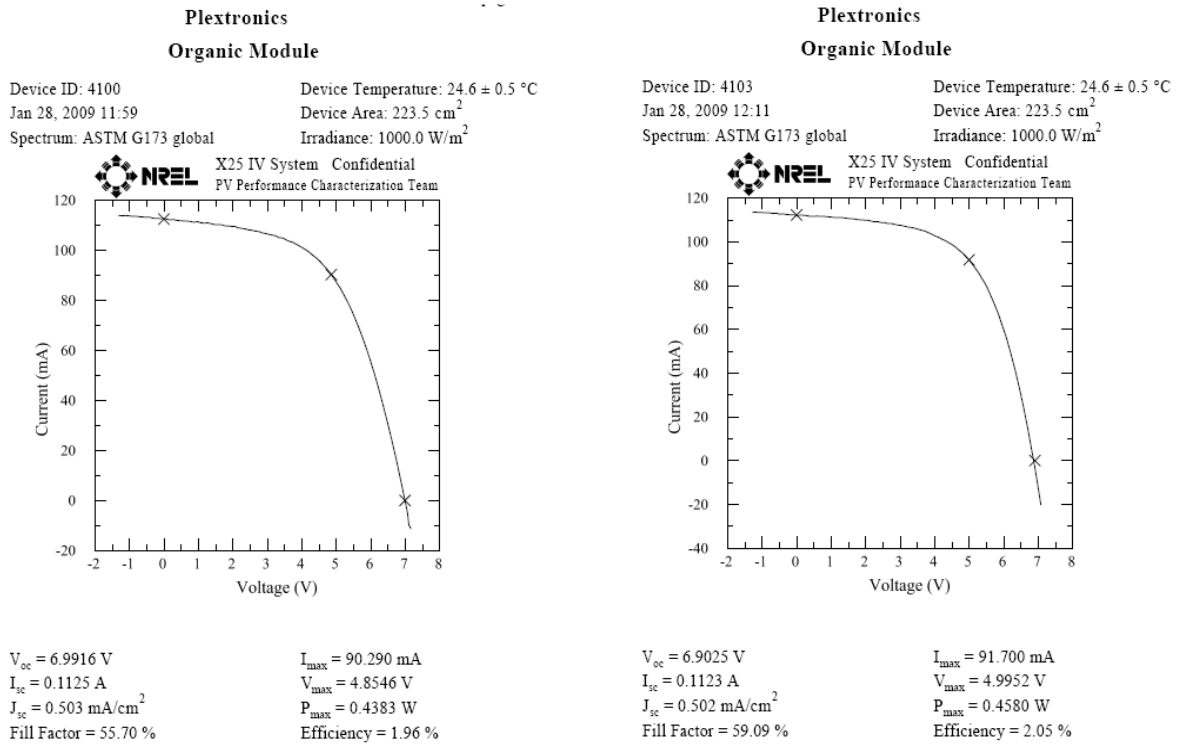

Figure 38: I-V OPV module (a) 4100 certified to 1.96% efficiency (4.06% active area efficiency) and (b) 4103 certified to 2.05% efficiency (4.24% active area efficiency) at NREL

MILESTONE #19: Module Lifetime.

KEY METRICS: 5000 hours

The photograph in Figure 39 shows Plextronics' OPV module and lab-cell lifetime testing set-up where currently nine OPV modules are on test under ~ 1 Sun illumination (Module 3541, under discussion, is identified). Module 3541, with an initial efficiency of 3.3%, was tested at regular intervals under open circuit conditions beneath a 1 sun solar simulator, i.e. 1000 W/m^2 adjusted with a National Renewable Energy Laboratory (NREL) certified KG-5 Si reference cell. The spectral mismatch was used to correct the current density. The module was made with the same materials, architecture and processes as used to meet Plextronics SAI subcontract milestone #18 (Module with 3.5% active area efficiency). Figure 40 (left) shows the normalized power output of the module after 1728 hours. Application of a linear fit to the data gives a decay rate of 3.77% per 1000 hours, which corresponds to a lifetime of 5298 hours under the old lifetime definition. Based on the modification of the lifetime definition we proposed in milestone #17, the actual lifetime of the module is expected to be greater than 10,000 hours. Figure 40 (right) shows the J-V characteristics of the module under illumination at periodic intervals.

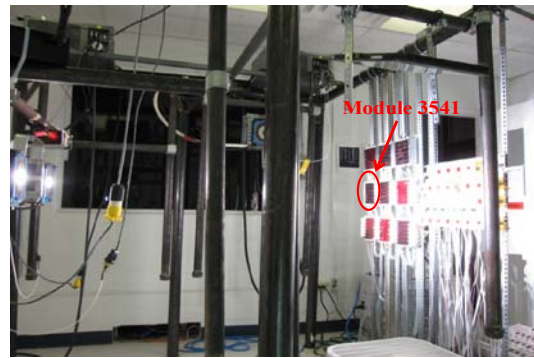

Figure 39: Plextronics' lifetime setup. Module 3541 is marked.

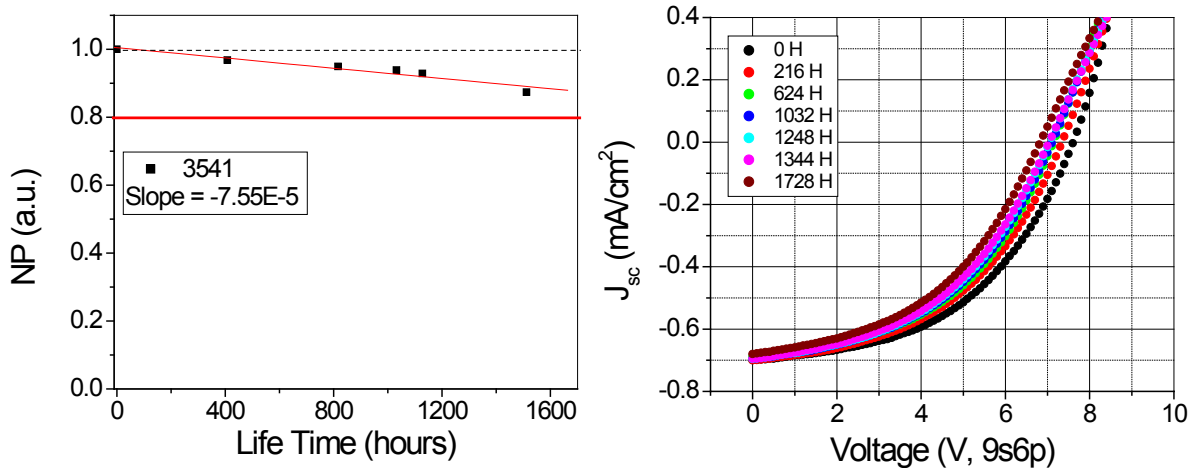

Figure 40 (left): Normalized power output of Module 3541 tested over periodic intervals under AM1.5G solar simulator. The decay rate of 3.77%/1000 hours corresponds to lifetime of 5298 hours under old definition and over 10,000 hours as per the modified definition; (right): AM1.5G solar simulation J-V characteristics of the Module 3541 under ~ 1 Sun Xe lamp.

MILESTONE # 20: Deliver Monolithic Stripe Design Module.

KEY METRICS: Active area (>95 cm²) Efficiency >2%; Total area Efficiency >0.82% (NREL-certified).

20.1 Plextronics Module Designs

20.1.1 9s6p Design

OPV modules are fabricated on a 150 mm × 150 mm ITO coated glass substrate, which has been fortified with a metal frame for improved collection of holes. For the prior deliverables, the modules were designed with a specific configuration of cells to allow maximum utilization of area, while delivering the optimum operating voltage for a particular application. Figure 41 shows the design of a Plextronics module which consists of 54 identical cells, each having an active area of 1cm × 2cm. The cells are organized in six parallel columns, each containing nine cells that are connected in series by internal wiring. The columns are electrically isolated, which provides an opportunity to independently measure each column's performance. External wiring is used to configure the module in several ways. The cells are connected in 9s6p configuration (6 columns connected in parallel). This design was adopted for development purpose.

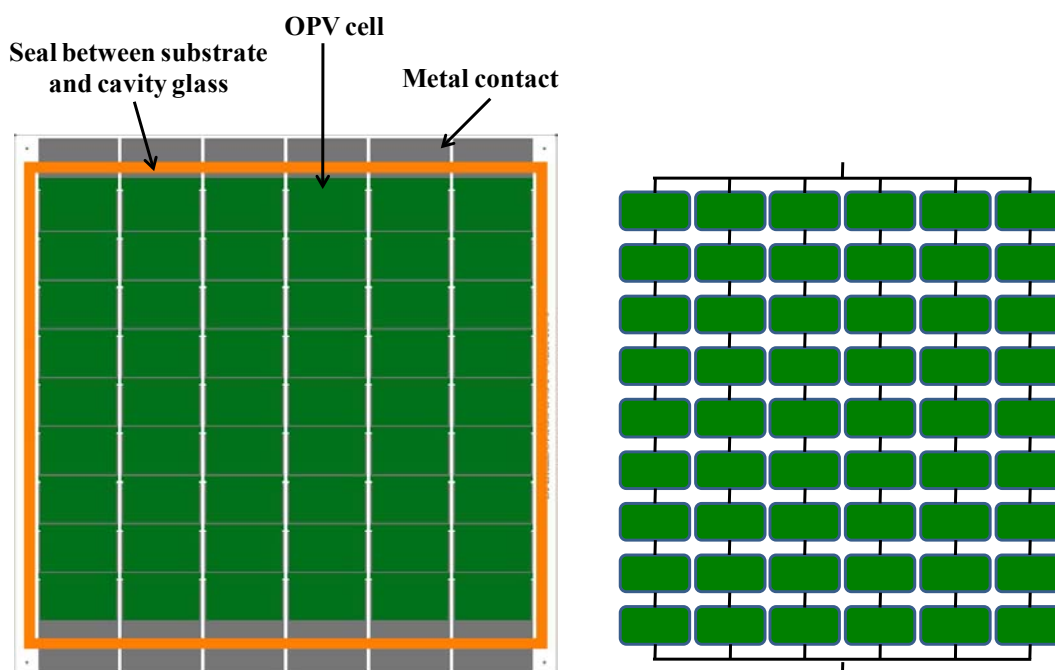

Figure 41: Design of Plextronics OPV Module, with 54 identical cells connected in 6 parallel columns of 9 cells each (right).

20.1.2 Stripe Design

We have redesigned the OPV module topology in order to improve its aperture ratio and at the same time to improve its manufacturability. The Stripe Module v.1.1 consists of 10 stripes, each having active area of 9.9 cm² (total active area of 99 cm²). The stripes are internally connected in series (into one wide column) as shown in Figure 42. The Aperture Ratio has been improved from 0.46 for previous design to 0.623 for the stripe design. The number of stripes has been design to produce a module with V_{pp} = 6.0 V.

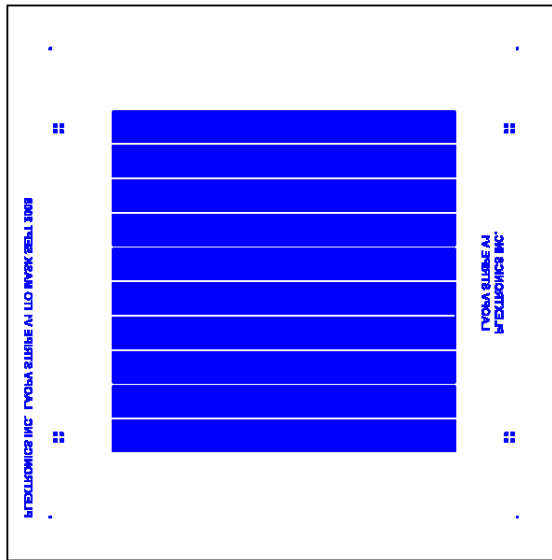

Figure 42: Stripe organization on new Stripe Module v.1.1 (ITO pattern)

20.2 *Module Efficiency*

Plextronics has demonstrated NREL-certified OPV module efficiency of 1.30% (total area) that translates to 2.09% when re-calculated for Active Area (using Aperture Ratio of 0.64). Figure 43 shows the NREL-certified data for Module 4202.

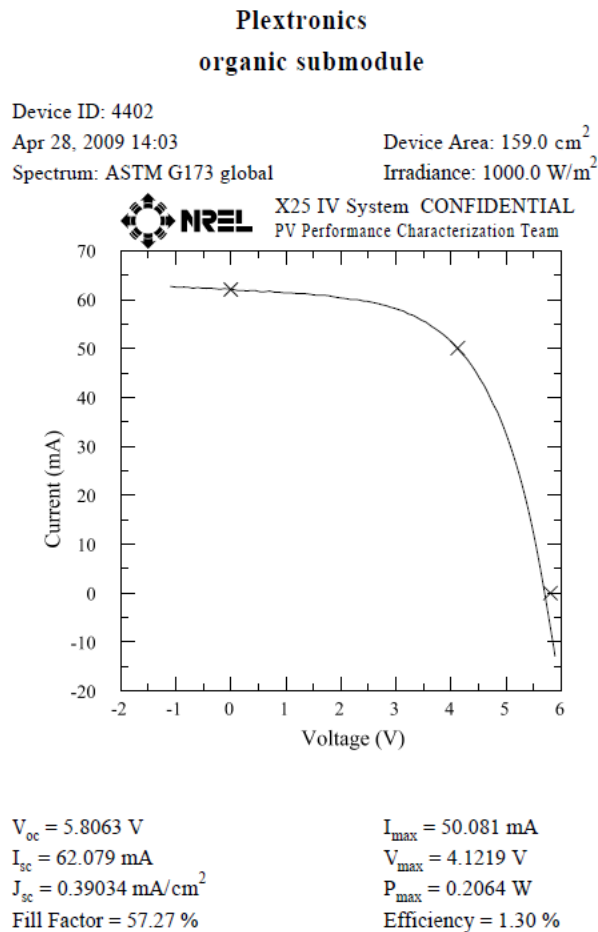

Figure 43: I-V data of OPV module NREL-certified to 2.09% active area efficiency

MILESTONE # 21: Monolithic Stripe Design Module.

KEY METRICS: Module with 1000 hours light-soaking (100% duty cycle) near 25 °C, >1.6% final active area efficiency (0.66% total area) (NREL-certified).

The lifetime and stability of a 150 mm × 150 mm Plexcore® PV2000 ink system on a monolithic (R&D) ‘stripe’ module under 1000 hours of continuous light soaking conditions was reported. We found that once the encapsulation seal had been engineered to ensure good adhesion between the cap glass and glass substrates, these modules demonstrate good stability - degrading only 20% of their initial performance. Figure 44 shows the NREL-certification of the ‘stripe’ design module after 1000 hours of light soaking under 1 sun Xe-lamp. The module was measured to exhibit 2.71% active area efficiency (1.71% total area efficiency). The aperture ratio is 0.63.

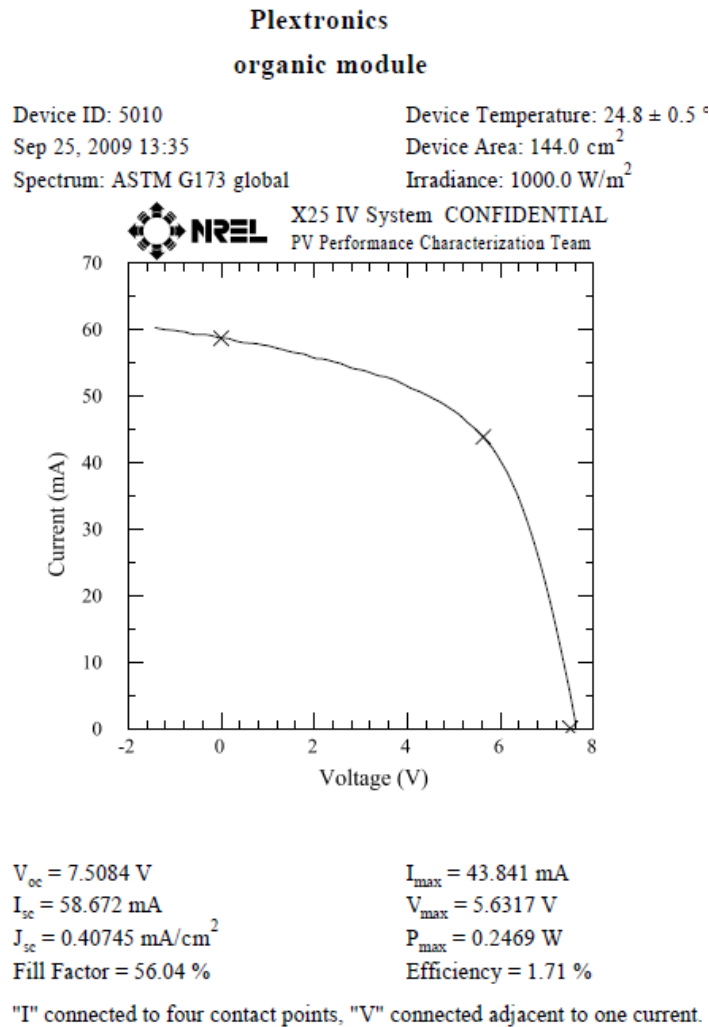

Figure 44: NREL-certification of ‘stripe’ design module after 1000 hours of light soaking

MILESTONE #22: OPV Module Outdoor Lifetime.

KEY METRICS: Data comparison analysis of at least 6 modules for outdoor testing (at least 1000 hours data collection, real time) at Golden, CO and Pittsburgh, PA.

We have setup two identical outdoor testing stations at Golden, CO and Pittsburgh, PA at 5/22/2009 and 6/6/2009, respectively (see Figure 45). 9 OPV modules have been working very well and their performance is being monitored on each station. So far all modules have experienced > 1500 hours outdoor exposure from both locations.



Figure 45: Two identical testing stations at Golden, CO and Pittsburgh, PA

The modules are tested in 9s6p mode once every 10 seconds. The data include the time, current, voltage, power, temperature, and pyranometer signals. The data are used in the calculations below.

1. Data is chosen at 1 sun illumination ($990\sim 1010\text{ W/m}^2$) determined by a calibrated pyranometer.
2. From this illumination, we calculate the efficiency for each module as $\eta = P/B$, where P = power output from module in W/m^2 and B = illumination level in 1000 W/m^2 .
3. Each day, we calculate the average η value as the simple mean of all the values calculated in #2 at a constant illumination of 1 sun ($1000\pm 10\text{ W/m}^2$).

The normalized data are plotted as η vs. *time*. Results from Golden, CO and Pittsburgh, PA were shown in Figure 46. Green and purple lines indicate devices made with our Plexcore[®] PV1000 and Plexcore[®] PV2000 inks, respectively. We can see there is an outlier module for each of station which may represent a poor performing module on each plot.

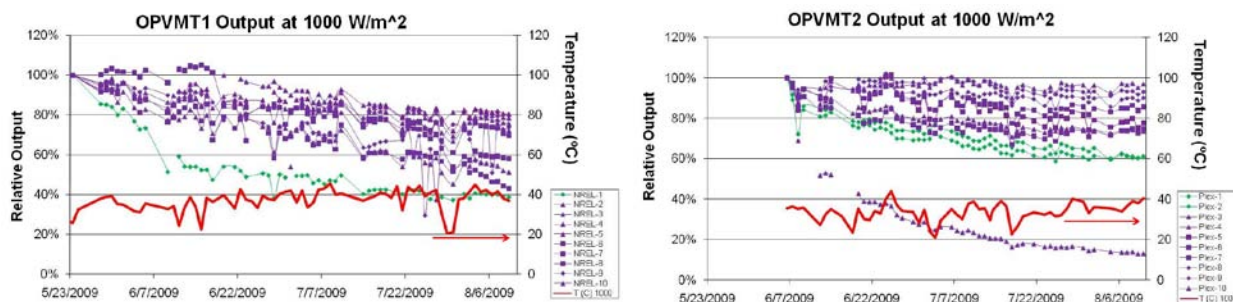

Figure 46: Outdoor output of OPV Modules at Golden, CO (left) and Pittsburgh, PA (right)

The modules at NREL are observed to degrade faster than the representative set at Plextronics. Our indoor lifetime experiments have implicated the irradiation is a primary degradation factor. The difference in temperature between the two sites may have some contribution to the degradation. Averaged irradiance difference between NREL and Plextronics is $5.66\text{ kWh/m}^2/\text{day}$ vs. $4.19\text{ kWh/m}^2/\text{day}$ (determined by Pyranometer) during testing period. The difference in the degradation rate of the best 3 modules from NREL and Plextronics is $10.8\%/khrs$ vs. $6.21\%/khrs$. The analysis is not statistically studied, however it directionally explores the root of degradation.

MILESTONE #23: Deliver 9s6p Module fabricated on D-Line.

KEY METRICS: Active area (>95 cm²) Efficiency >1.5%; Total area Efficiency >0.7% (NREL-certified).

23.1 Module Fabrication on the D-Line

The main purpose of D-line is to demonstrate Plextronics’ potential customers that our solution processable inks will support the migration from R&D into manufacturing environment. For that reason the application technique for depositing of active layer (AL) was changed from spinning to slot-die coating. This technique was chosen because of very good field test results, very good utilization of the ink (minimum waste) and for compatibility with flexible substrates processing. The change of application technique induced additional processing changes that were necessitated by practicality of each particular operation. The part of process in which the changes occurred is shown below (*HTL – Hole transport layer*):

| <u>R&D</u> | <u>D-Line</u> |
|----------------------------------|----------------------------------|
| HTL spun on in air | HTL spun on in air |
| HTL annealed in inert atmosphere | HTL annealed in air |
| AL spun on in inert atmosphere | AL coated by slot die in air |
| No exposure to vacuum | Exposed to vacuum (ante chamber) |
| AL annealed in inert atmosphere | AL annealed in inert atmosphere |

23.2 Module Efficiency

Plextronics has demonstrated NREL-certified OPV module efficiency of 1.43% (total area) that translates to 3.08% when re-calculated for Active Area (using Aperture Ratio of 0.464). Figure 47 shows the NREL-certified data for Module 4/21-3. This module was fabricated on our manufacturing development line (D-Line) with the active layer (AL) deposited using slot-die coating.

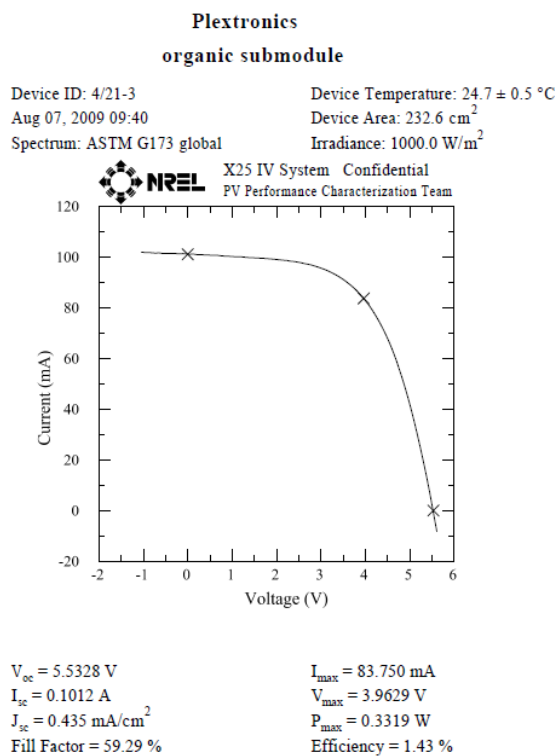

Using aluminum plate to elevate for kelvin connection on painted edges.

Figure 47: I-V data of D-line OPV module certified to 2.09% active area efficiency (1.3% active area efficiency) at NREL

MILESTONE #24: Effects of light soaking on modules.

KEY METRICS: Module with 500 hours light-soaking (100% duty cycle) near 25 °C, initial efficiency >2.5%, final efficiency >2% (1.2% and 0.93% total area efficiency) (NREL-certified).

Module #4612 (with active area=108 cm²) was evaluated indoors for 510 hrs under Xe-lamp (100% duty cycle) after light stabilizing the modules under Xe-lamp for 168hrs. The module was certified by NREL after the initial stabilization process and subsequent 500hr light soaking. The initial light stabilized active area efficiency for module #4612 was 4.49% (certified full area efficiency = 2.16%). The active area efficiency after an additional 510 hrs of light soaking was 4.33% (certified full area efficiency = 2.08%). The efficiency has degraded to ~3.6% of its initial efficiency, thus satisfying the deliverable requirement of <80% degradation of initial light stabilized efficiency. Figure 48 shows the NREL-certified data before (left) and after light soaking (right).

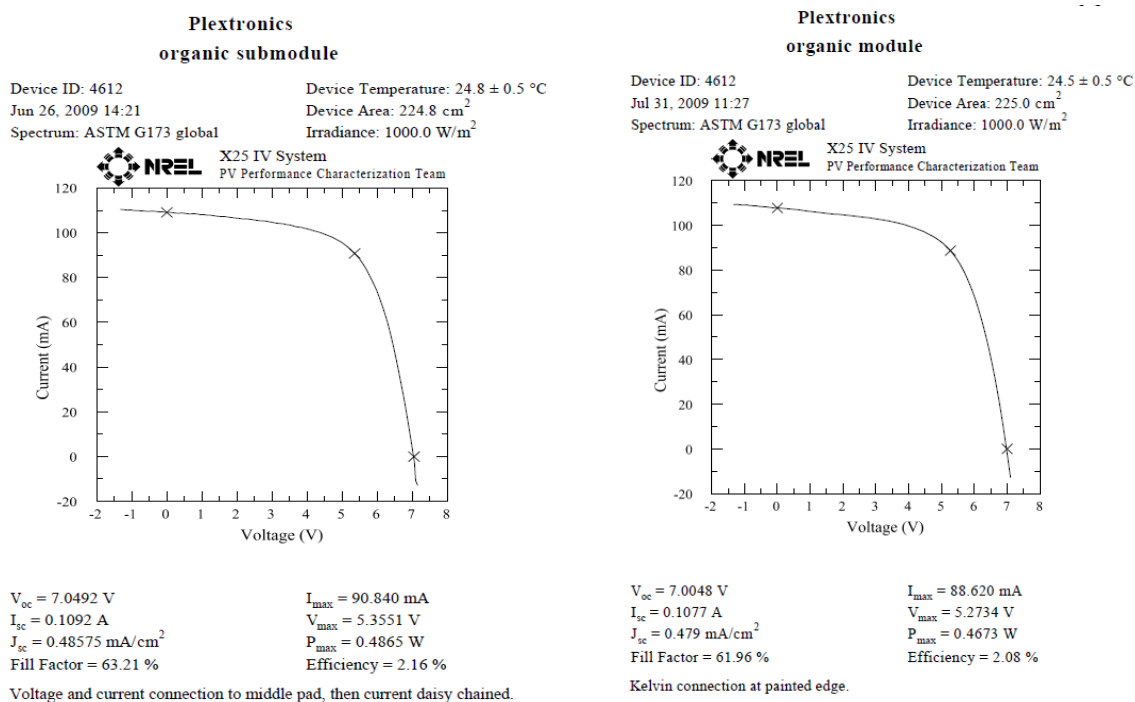

Figure 48: NREL certification of module #4612 before (left) and after 510 hrs of light stabilization under Xe-lamp at 1 sun (right)

MILESTONE #25: Stability of Modules at 85°C/85% Relative Humidity (RH) Conditions.

KEY METRICS: Module with 500 hours light-soaking near 85 °C/85% RH, Stability after 200 hours to be >50% of original, test to be conducted on module with >2% active area efficiency (0.93% total area efficiency).

The testing was carried out in a Q-Sun chamber that utilizes a Xe-arc lamp with a Daylight-Q filter, having a near spectral response match to the Xe-lamps utilized for ambient testing and reporting the module stability other PV-Incubator deliverables. A maximum achievable power output of 79 W/m² was maintained over the total UV region (295-320nm), which corresponds to a power irradiance of 1220 W/m² over the spectral region. This is 1.6 times the amount of irradiance that a module would see under ambient, Xe-lamp.

In Figure 49, the performance of a Plexcore[®] PV2000 ink system module under light soaking at “85°C/85%RH” testing conditions, 100% duty cycle, is presented. The initial, post fabrication device performance (T₀) was 2.72% active area power conversion efficiency (PCE). Directly after measurement, the module was loaded into the Q-Sun chamber. We found that it took 336 hours to reach 50% of initial post fabrication device performance (T₅₀), exceeding the deliverable metrics for this milestone. At T₅₀, the active area PCE was measured to be 1.36%. We observed that the module continued to degrade for up to 528 hours before undergoing catastrophic failure.

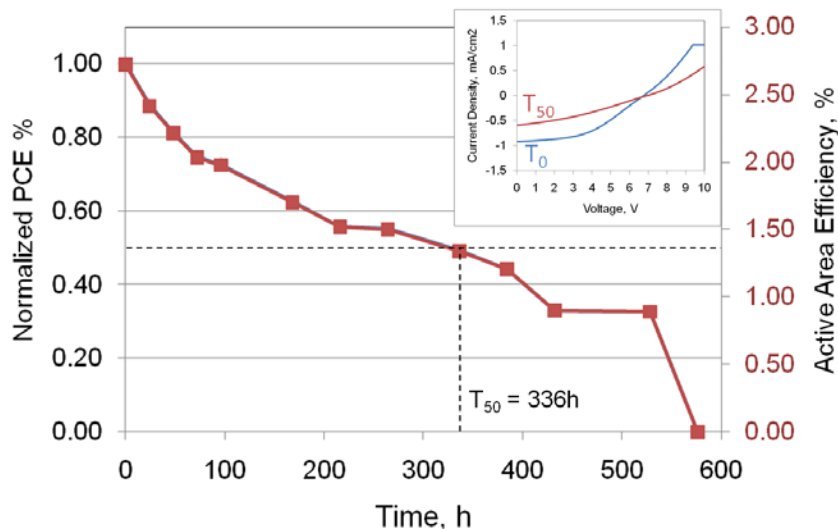

Figure 49: Performance of module under light soaking at “85°C/85%RH” testing conditions. It took 336 hours to reach 50% of initial post fabrication device performance (T₅₀). The JV plots at T₀ and T₅₀ are shown in the inset.

The ability to report the stability of modules under standardized, accelerated testing conditions paves the way to assessing the composite effect of materials, device configuration and encapsulants that comprise OPV thin film technology. The ability of OPVs to meet and exceed the rigorous testing methods set out by The International Electrotechnical Commission (IEC) will be an important milestone towards commercialization of this technology.

MILESTONE #26: Draft Final Report.

A draft of the final report was submitted to the technical monitor.

Conclusions and Outlook

Plextronics has successfully met on schedule, or in many cases ahead of schedule, all of the milestones (to date) set for the PV-Incubator program. Table 1 shows the metrics for efficiency and lifetime of lab-cells and modules as per the contract, and the actual targets that we achieved. It can be seen that we exceeded expectations for almost all of the milestones.

Table 3: Summary of efficiency and lifetime metrics (contract vs. actual)

| | Milestone # | Contract | Actual |
|---------------------------------|-------------|--|--|
| Lab-Cell Efficiency | 1 | 5.1% (NREL-cert) | 5.09% |
| | 2 | 5.4% (Internal) | 5.51% |
| | 5 | 5.4% (NREL-cert) | 5.42% |
| | 16 | 5.8% (NREL-cert) | 5.98% |
| Module Efficiency (active area) | 1 | 0.8% (Internal) | 1.07% |
| | 6 | 1% (Internal) | 1.07% |
| | 12 | 1.5% (NREL-cert) | 2.30% |
| | 18 | 3.5% (NREL-cert) | 4.24% |
| | 20 | 2% (NREL-cert) - new design | 2.09% |
| | 23 | 1.5% (NREL-cert) - D-Line | 3.08% |
| Lab-Cell Lifetime | 1 | 700 hours to T80 | 750 hours to T90 |
| | 10 | 3,723 hours to T80 | 5,600 hours to T80 (extrapolated) |
| | 17 | 5,776 hours to T80 | > 14,000 hours to T80 (extrapolated) |
| Module Lifetime | 12 | 2,000 hours to T80 | > 4,000 hours to T80 (extrapolated) |
| | 19 | 5,000 hours | > 10,000 hours to T80 (extrapolated) |
| | 21 | 1.6% efficiency (NREL-cert) after 1000 hours light soak - new design | 2.71% |
| | 24 | Initial efficiency = 2.5% (NREL-cert); 500 hours light soak; Final efficiency = 2% (NREL-cert) | Initial efficiency = 4.49%; Final efficiency = 4.33% |
| | 25 | Initial efficiency = 2%; 500 hours light soak at 85 °C/85RH; Efficiency at 50% of original after 200 hours | Initial efficiency = 2.72%; T50 at 336 hours |

The program has allowed us to expand our capabilities of organic materials synthesis, ink formulation, device design and fabrication, and device testing. Furthermore, during this program, we established and made operational our large-area OPV manufacturing development line (D-Line). Through these efforts, we are developing fabrication techniques to drive down manufactured costs of commercial design modules via high throughput processes. Figure 50 outlines our approach and our pathway towards achieving the SETP goals. We also look forward to a continuing relationship with NREL to establish standards for OPV technology.



MATERIALS EFFICIENCY

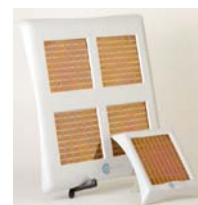

TRANSLATION TO MODULES



DEVICE LIFETIME



PROCESS DEVELOPMENT

Figure 50: Plextronics' approach: (1) Technology improvement via higher efficiency and longer lifetime; (2) Cost reduction via effective translation to commercial modules and high-throughput processes

REPORT DOCUMENTATION PAGE

Form Approved
OMB No. 0704-0188

The public reporting burden for this collection of information is estimated to average 1 hour per response, including the time for reviewing instructions, searching existing data sources, gathering and maintaining the data needed, and completing and reviewing the collection of information. Send comments regarding this burden estimate or any other aspect of this collection of information, including suggestions for reducing the burden, to Department of Defense, Executive Services and Communications Directorate (0704-0188). Respondents should be aware that notwithstanding any other provision of law, no person shall be subject to any penalty for failing to comply with a collection of information if it does not display a currently valid OMB control number.

PLEASE DO NOT RETURN YOUR FORM TO THE ABOVE ORGANIZATION.

| | | | | | | |
|--|------------------------------------|-------------------------------------|---|--|--|--|
| 1. REPORT DATE (DD-MM-YYYY) December 2009 | | | 2. REPORT TYPE Subcontractor Report | | 3. DATES COVERED (From - To) 09/28/2007-10/27/2008 | |
| 4. TITLE AND SUBTITLE Economic On-Grid Solar Energy via Organic Thin Film Technology: 28 September 2007 - 27 October 2008 | | | | 5a. CONTRACT NUMBER DE-AC36-08-GO28308 | | |
| | | | | 5b. GRANT NUMBER | | |
| | | | | 5c. PROGRAM ELEMENT NUMBER | | |
| 6. AUTHOR(S) D. Laird, J. Bernkopf, S. Jia, J. Krieg, S. Li, C. McGuinness, J. Rossier, M. Storch, R. Tipnis, R. Tuttle, B. Woodworth, and S. Williams | | | | 5d. PROJECT NUMBER NREL/SR-520-47289 | | |
| | | | | 5e. TASK NUMBER PVB92110 | | |
| | | | | 5f. WORK UNIT NUMBER | | |
| 7. PERFORMING ORGANIZATION NAME(S) AND ADDRESS(ES) Plextronics, Inc. 2180 William Pitt Way Pittsburgh, Pennsylvania 15238 | | | | 8. PERFORMING ORGANIZATION REPORT NUMBER NAT-7-77015-06 | | |
| 9. SPONSORING/MONITORING AGENCY NAME(S) AND ADDRESS(ES) National Renewable Energy Laboratory 1617 Cole Blvd. Golden, CO 80401-3393 | | | | 10. SPONSOR/MONITOR'S ACRONYM(S) NREL | | |
| | | | | 11. SPONSORING/MONITORING AGENCY REPORT NUMBER NREL/SR-520-47289 | | |
| 12. DISTRIBUTION AVAILABILITY STATEMENT National Technical Information Service U.S. Department of Commerce 5285 Port Royal Road Springfield, VA 22161 | | | | | | |
| 13. SUPPLEMENTARY NOTES NREL Technical Monitor: Bolko von Roedern | | | | | | |
| 14. ABSTRACT (Maximum 200 Words) The goal of Plextronics, Inc.'s Solar America Initiative PV Incubator contract was to take its organic photovoltaic (OPV) technology from laboratory-scale and demonstrate a pathway to 3-W manufacturing capacity (~2010) and 7 cents/kWh levelized cost of energy by 2015. The work supports the Solar Energy Technology Program charter as follows: (1) Driving commercialization of novel, low-cost thin-film PV technology by developing commercial high-performance OPV inks to enable module production; (2) Systematically, quantitatively evaluating technological options on the pathway to achieving grid parity with conventional power sources; (3) Demonstrating an OPV module development line and using it as a pathway to establishing a high-volume manufacturing facility that will eventually contribute to U.S. installed domestic capacity for PV systems. Plextronics used a three-pronged approach to meet the Incubator goals: (1) Drive device efficiency via materials development; (2) Improve stability and lifetime via device design and process development; (3) Translate lab-scale performance to large-area modules by establishing a pilot manufacturing-development line to evaluate manufacturing-worthy processes. | | | | | | |
| 15. SUBJECT TERMS PV; on-grid; solar energy; organic photovoltaics; thin film; manufacturing; capacity; large-area modules | | | | | | |
| 16. SECURITY CLASSIFICATION OF: | | | 17. LIMITATION OF ABSTRACT UL | 18. NUMBER OF PAGES | 19a. NAME OF RESPONSIBLE PERSON | |
| a. REPORT Unclassified | b. ABSTRACT Unclassified | c. THIS PAGE Unclassified | | | 19b. TELEPHONE NUMBER (Include area code) | |