

# Plug-In Hybrid Vehicle Analysis

**Milestone Report**  
**NREL/MP-540-40609**  
**November 2006**

T. Markel, A. Brooker, J. Gonder, M. O'Keefe,  
A. Simpson, and M. Thornton  
*National Renewable Energy Laboratory*

NREL is operated by Midwest Research Institute Battelle Contract No. DE-AC36-99-GO10337



# Plug-In Hybrid Vehicle Analysis

**Milestone Report**  
**NREL/MP-540-40609**  
**November 2006**

T. Markel, A. Brooker, J. Gonder, M. O'Keefe,  
A. Simpson, and M. Thornton  
*National Renewable Energy Laboratory*

Prepared under:  
Task No. FC06.2000  
B&R Code VT0103000

Prepared for the U.S. Department of Energy  
Office of Energy Efficiency and Renewable Energy

In fulfillment of:  
FreedomCAR and Vehicle Technologies Program  
September 2006 Milestone/Deliverable  
6.3 Grid-Connected Hybrid Vehicle Efficiency Improvement Analysis

**National Renewable Energy Laboratory**  
1617 Cole Boulevard, Golden, Colorado 80401-3393  
303-275-3000 • [www.nrel.gov](http://www.nrel.gov)

Operated for the U.S. Department of Energy  
Office of Energy Efficiency and Renewable Energy  
by Midwest Research Institute • Battelle

Contract No. DE-AC36-99-GO10337

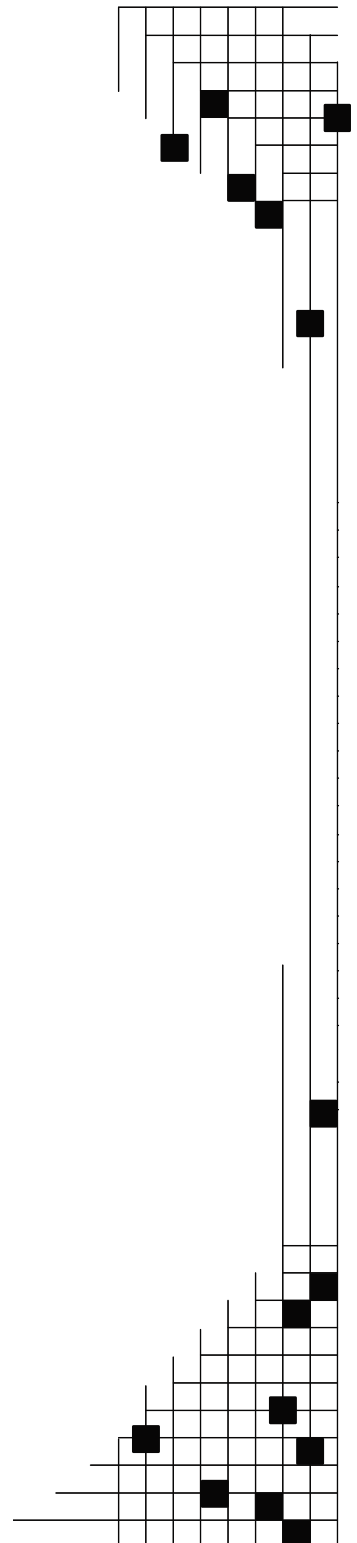

## NOTICE

This report was prepared as an account of work sponsored by an agency of the United States government. Neither the United States government nor any agency thereof, nor any of their employees, makes any warranty, express or implied, or assumes any legal liability or responsibility for the accuracy, completeness, or usefulness of any information, apparatus, product, or process disclosed, or represents that its use would not infringe privately owned rights. Reference herein to any specific commercial product, process, or service by trade name, trademark, manufacturer, or otherwise does not necessarily constitute or imply its endorsement, recommendation, or favoring by the United States government or any agency thereof. The views and opinions of authors expressed herein do not necessarily state or reflect those of the United States government or any agency thereof.

Available electronically at <http://www.osti.gov/bridge>

Available for a processing fee to U.S. Department of Energy and its contractors, in paper, from:

U.S. Department of Energy  
Office of Scientific and Technical Information  
P.O. Box 62  
Oak Ridge, TN 37831-0062  
phone: 865.576.8401  
fax: 865.576.5728  
email: <mailto:reports@adonis.osti.gov>

Available for sale to the public, in paper, from:

U.S. Department of Commerce  
National Technical Information Service  
5285 Port Royal Road  
Springfield, VA 22161  
phone: 800.553.6847  
fax: 703.605.6900  
email: [orders@ntis.fedworld.gov](mailto:orders@ntis.fedworld.gov)  
online ordering: <http://www.ntis.gov/ordering.htm>



# Preface

The Vehicle Systems Team in the Center for Transportation Technologies and Systems at the National Renewable Energy Laboratory (NREL) performed this work. This report documents completion of the September 2006 milestone as part of NREL's 2006 FreedomCAR and Vehicle Technologies (FCVT) Annual Operating Plan with the U.S. Department of Energy (DOE). The objective of the work was to provide objective systems simulations and analysis of plug-in hybrid electric vehicle technologies.

This report supports the goals of the DOE/FCVT Program to quantify the potential benefits of plug-in hybrid electric vehicle technology through analysis and modeling. Specifically, this effort supports Task 1: Modeling and Simulation, discussed in the FCVT Multi-Year Program Plan.

This work was funded by the Advanced Vehicle Technology Analysis and Evaluation activity in support of the FCVT Program of the Office of Energy Efficiency and Renewable Energy within the U.S. DOE. We wish to thank our sponsor, Lee Slezak, for his guidance and support. Terry Penney, as NREL's FCVT technology manager, and Matt Thornton, as task leader for NREL's Vehicle Systems Analysis Task, supported this project.

We would also like to express our appreciation to the members of the FreedomCAR Vehicle Systems Analysis Technical Team: Larry Laws (GM), Mark Biernacki (DaimlerChrysler), and Asi Perach (Ford) for providing technical insight and industry review.

Tony Markel, project leader

# Table of Contents

## Executive Summary

### Section 1: Plug-In Hybrid Electric Vehicle Fuel Economy Reporting Methods

- Section 1.1: “Measuring and Reporting Fuel Economy of Plug-In Hybrid Vehicles,” presented to the Vehicle Systems Analysis Technical Team, Feb. 1, 2006
- Section 1.2: “Measuring and Reporting Fuel Economy of Plug-In Hybrid Electric Vehicles,” published at the 22nd International Battery, Hybrid, and Fuel Cell Electric Vehicle Symposium and Exposition, October 2006

### Section 2: Plug-In Hybrid Electric Vehicle Cost and Consumption Benefit Analysis

- Section 2.1: “Cost/Benefit Analysis of Hybrid-Electric and Plug-In Hybrid-Electric Vehicle Technology,” presented to the Vehicle Systems Analysis Technical Team, March 1, 2006 (updated May 2006)
- Section 2.2: “Cost-Benefit Analysis of Plug-In Electric Vehicle Technology,” published at the 22nd International Battery, Hybrid, and Fuel Cell Electric Vehicle Symposium and Exposition, Oct. 26, 2006
- Section 2.3: “Plug-In Hybrid Electric Vehicles: Current Status, Long-Term Prospects, and Key Challenges,” presented at the Federal Network for Sustainability Meeting, July 20, 2006
- Section 2.4: “Plug-In Hybrid Electric Vehicle Energy Storage Analysis,” presented to the FreedomCAR Electrochemical Energy Storage Technical Team Plug-In Hybrid Electric Vehicle Battery Working Group Meeting, July 25, 2006
- Section 2.5: “Plug-In Hybrid Modeling and Application: Cost/Benefit Analysis,” presented at the Third AVL Summer Conference on Automotive Simulation Technology, Aug. 24, 2006

### Section 3: Plug-In Hybrid Electric Vehicle Real-World Performance Expectations

- Section 3.1: “Plug-In Hybrid Electric Vehicles: Current Status, Long-Term Prospects, and Key Challenges,” presented at the Clean Cities Congress and Expo, May 8, 2006
- Section 3.2: “Plug-In Hybrid Vehicle Real-World Performance Expectations,” presented to the Vehicle Systems Analysis Technical Team, June 14, 2006
- Section 3.3: “Using GPS Travel Data to Assess the Real-World Driving Energy Use of Plug-In Hybrid Electric Vehicles,” to be published at the Transportation Research Board 86th Annual Meeting, February 2007

## **Section 4: Plug-In Hybrid Electric Vehicle Energy Management Strategies**

- Section 4.1: “Plug-In Hybrid Electric Vehicle Energy Storage System Design,” presented at the Advanced Automotive Battery Conference, May 19, 2006
- Section 4.2: “Plug-In Hybrid Electric Vehicle Energy Storage System Design,” published at the Advanced Automotive Battery Conference, May 19, 2006
- Section 4.3: “Dynamic Programming Applied to Investigate Energy Management Strategies for a Plug-In Hybrid Electric Vehicle,” to be published at the 22nd International Battery, Hybrid, and Fuel Cell Electric Vehicle Symposium and Exposition, October 2006

## **Summary**

# **Plug-In Hybrid Vehicle Analysis**

## *Milestone Report*

September 2006

Tony Markel

Aaron Brooker, Jeffrey Gonder, Michael O'Keefe, Andrew Simpson, Matthew Thornton

In fulfillment of FreedomCAR and Vehicle Technologies Program September 2006  
Milestone/Deliverable **6.3 *Grid-Connected Hybrid Vehicle Efficiency Improvement Analysis***

## **Executive Summary**

NREL's plug-in hybrid electric vehicle (PHEV) analysis activities have made great strides in FY06 to objectively assess PHEV technology, support the larger U.S. Department of Energy PHEV assessment effort and complementary activities at other national laboratories, and share technical knowledge with the vehicle research community and vehicle manufacturers through the FreedomCAR Vehicle Systems Technical Team and the Electrochemical Energy Storage Technical Team. The key contributions of this activity include:

1. Proposed improvements to the existing test procedure for reporting PHEV fuel economy
2. A thorough exploration of the PHEV design space, including an evaluation of the trade-offs between cost and fuel consumption
3. The application of real-world driving data to quantify the impacts of travel behavior on the potential benefits of PHEVs
4. The optimization of energy management strategies focusing on petroleum displacement.

The NREL research team has participated in many key industry meetings, and its research has been documented in eight formal presentations and five technical papers that have been published or have been submitted for publication within the next 6 months. This milestone report is a compilation of these papers and presentations for future reference.

The following is a summary of important insights that emerged from the four areas of emphasis.

### **Plug-In Hybrid Electric Vehicle Fuel Economy Reporting Methods**

PHEVs differ significantly from existing vehicles. They consume two fuels (petroleum and electricity) at rates that depend on the distance driven and the aggressiveness of the cycle. The Society of Automotive Engineers J1711 Recommended Practice, created in 1999, provides the fundamentals for measuring fuel economy of off-vehicle charge-capable vehicles (i.e., plug-in hybrids and electric vehicles). Seven years later, with a much better understanding of how PHEVs will likely operate, some improvements to the original procedure are recommended. The team's specific recommendations are:

- Report gasoline and electricity consumption separately, which allows the reported results to be used for vehicle operating cost comparisons, fuel consumption, and CO<sub>2</sub> emissions estimates.
- Revise the end-of-test criteria to more accurately determine the distance driven in charge-depleting mode, fully capture the petroleum displacement potential of longer-range PHEVs, and improve the reporting accuracy for short-range PHEVs.

- Assume that vehicles will be fully charged once per day because there is an economic incentive for consumers to recharge their vehicles at least once per day, if not more often.

The recommended improvements to the fuel economy reporting methods have been adopted in our analyses, and the team intends to work with other labs and regulatory agencies to enact similar improvements in their procedures. The analysis also identified the need to develop a new utility factor relationship, based on the best available travel survey data, and to explore the implementation of a driving-type specific utility factor to account for the fact that most short-distance travel will be urban in nature and most long-distance travel will be highway in nature. Finally, it has been determined that the current Environmental Protection Agency certification cycle adjustment factors provide an inaccurate prediction of real-world PHEV consumption and should also be revised.

For a more detailed discussion of this effort, please refer to sections 1.1 and 1.2.

### **Plug-In Hybrid Electric Vehicle Cost and Consumption Benefit Analysis**

“Comparing the Benefits and Impacts of Hybrid Electric Vehicle Options,” a report published by the Electric Power Research Institute in July 2001, was a unique study that stands as a comprehensive analysis of hybrid electric vehicle and PHEV technology implementation. NREL contributed vehicle system simulation results to this report. The analysis scope was limited to just a few vehicle scenarios, including conventional, HEV0, PHEV20, and PHEV60. These vehicles were designed to achieve all-electric operation on the urban cycle for the specified distance.

NREL recently developed a rapid design exploration methodology and applied the methodology to an expanded PHEV analysis spectrum that includes PHEVs with a wide range of power and energy capabilities. In particular, the scope included PHEVs with limited all-electric capabilities that are still able to realize tangible petroleum displacement by operating in a “blended” charge-depleting mode.

Key conclusions from the analyses are:

- The PHEV<sub>x</sub> definition should be based on the *energy equivalent all-electric range* of the energy storage system, rather than on actual all-electric range (the distance before first engine turn-on event). The current all-electric range focused definition constrains the PHEV design space and is not necessarily directly related to petroleum displacement.
- The expected petroleum reduction of a PHEV is substantial, but the incremental costs may present a barrier to broad market penetration. A PHEV20 would likely reduce petroleum consumption by 50% but cost \$8,000 more than a conventional vehicle. The PHEV40 would cost \$11,000 more than a conventional vehicle and may reduce petroleum consumption by 62%.
- Data in open literature support an inverse correlation between battery cycle life and cycle depth of discharge. To provide equivalent cycle life performance, the usable state-of-charge window of a short-range PHEV must be significantly less than that of a long-range PHEV. For example, for a 15-year life, a PHEV10 can only use 41% of the capacity, while a PHEV60 may use up to 73% and still achieve battery life targets.
- If PHEVs are to provide a payback relative to a hybrid electric vehicle within 10 years, based on fuel cost savings and purchase cost alone, battery costs must reach long-term, high-volume cost estimates (<\$300/kWh), and gasoline costs must increase to more than \$4/gal. In the absence of both lower battery costs and higher gas prices, alternative value propositions (e.g., government incentives, vehicle-to-grid revenue, battery leases, the value of a “green” image, avoided trips to the gas station, and the feel of electric operation) must be considered to overcome the cost premium of PHEVs.



The analysis thus far has not allowed vehicle platform engineering as a strategy to reduce costs and improve fuel economy. Aerodynamics and vehicle light-weighting will likely have a more pronounced impact on PHEVs than any other configuration. Future analysis will focus on vehicle platform enhancements and their impact on the relative costs and benefits of PHEVs. In addition, design options and alternative business models will be explored to address the high cost of batteries for PHEVs.

For more extensive discussion of this topic, please refer to sections 2.1, 2.2, 2.3, 2.4, and 2.5.

### **Plug-In Hybrid Electric Vehicle Real-World Performance Expectations**

The consumption of electricity and petroleum by a PHEV will be strongly influenced by the daily distance traveled between recharge events and the aggressiveness of driving. Rather than rely on standard test profiles for a prediction of PHEV fuel consumption, we have collaborated with municipalities to use existing drive cycle databases as inputs to our simulation models. The simulation results provide key insights into consumer travel behavior and quantify the real-world potential for PHEVs to displace petroleum. The first data set was from the St. Louis, Missouri, metropolitan area and includes 227 unique driving profiles, with daily travel distances ranging from less than a mile to more than 270 miles.

Conclusions from the travel survey data are:

- Approximately 50% of the vehicles traveled less than 29 miles a day. A PHEV with 20–30 miles of electric range capability provides sufficient energy to displace a large percentage of daily petroleum consumption. Because many vehicles drive less than 30 miles a day, the battery of a PHEV with 30 or more miles of electric range capability would likely be under-utilized on a daily basis.
- The travel survey data demonstrated that there is a broad spectrum of driving behavior, varying from short to long distances and from mild to aggressive driving intensities. The Urban Dynamometer Driving Schedule and Highway Fuel Economy Test driving profiles used for fuel economy reporting today fall short of capturing the typical driving behavior of today's consumer.
- Contrary to experience with hybrid electric vehicles, which typically deliver fuel economies significantly less than their rated values, simulations of real-world driving suggest that a large percentage of drivers of PHEVs will likely observe fuel economies in excess of the rated fuel economy values. However, because of high power requirements in real-world cycles, drivers are unlikely to experience significant all-electric operation if PHEVs are designed for all-electric range on the Urban Dynamometer Driving Schedule.
- If all vehicles in the travel survey "fleet" were PHEV20 vehicles designed for all-electric range on the Urban Dynamometer Driving Schedule, petroleum consumption would be reduced by 56% relative to a conventional vehicle fleet. The PHEV40 reduced consumption by an additional 12% and was equivalent to  $\approx 1$  gal/vehicle/day of petroleum savings. Including electricity costs, the average annual fuel costs savings for the "fleet" of PHEVs is more than \$500/vehicle/year.
- The time-of-day usage pattern obtained from global positioning system (GPS) travel survey data and the recharge requirements from simulation will be extremely valuable for determining the impact of PHEV recharging scenarios on the electric utility grid.

Since the St. Louis analyses were completed, data from five other metropolitan GPS travel surveys have been obtained. The driving profile database will expand from 227 to more than 2,000 vehicles. Additional analyses will be completed using the full collection of more than 2,000 driving profiles. Real-world travel simulations will be executed to consider variations in platform, aerodynamics, performance, control, and recharge scenarios. In addition, the database will be used to explore the emissions control implications of potential engine cold-starts and the fuel consumption impacts of location-specific air conditioning use.

For more extensive discussion of this topic, please refer to sections 3.1, 3.2, and 3.3.

### **Plug-In Hybrid Electric Vehicle Energy Management Strategies**

Discussion in many PHEV forums has focused on how the PHEV will function and, more specifically, on how the vehicle will use the battery and engine in combination to improve efficiency and displace petroleum.

NREL's vehicle systems analysis team has a long history of applying optimization tools to explore hybrid electric vehicle energy management strategies. During the past fiscal year, two parallel efforts were initiated. The first explored the extensive PHEV design space and identify promising regions (using the modeling techniques developed for the cost-benefit study). The second applied dynamic programming techniques to determine the "near optimal" power distribution among the engine, motor, and battery in a PHEV for a known driving profile. NREL's energy management strategy work is critical for maximizing the petroleum savings while protecting the batteries of future hybrid vehicles.

The conclusions from these analyses are:

- The misconception that a PHEV<sub>x</sub> must drive using electricity for the first x miles and then use the engine for the remaining travel must be clarified. This is one strategy that a manufacturer may choose to pursue, but it is not the only strategy. As long as the strategy is achieving a net discharge of the battery, petroleum will be displaced, regardless of whether the vehicle is operated on battery only or on a combination of battery and engine power (known as a "blended" control strategy).
- The selection of strategy and component sizing are not entirely independent. Reducing the rated power and size of the electric traction components is one way to reduce the cost of a PHEV. Reducing electric components also necessitates the use of a "blended" strategy. The "blended" strategy can still utilize electric propulsion to the maximum extent possible to minimize the vehicle's instantaneous fuel use. NREL's analysis shows that a PHEV with electric traction components half the size (based on power) of an all-electric PHEV can provide nearly the same petroleum reduction as an all-electric PHEV.
- Dynamic programming optimization of PHEV energy management strategies indicated that optimum control based on *a priori* knowledge of the driving cycle provided marginally better petroleum savings than a strategy that used stored electric energy to the greatest extent possible. On the other hand, if the real-world driving distance turned out to be less than that predicted for dynamic programming, then the "optimally" blended strategy would consume significantly more fuel than the electric energy-focused strategy over the length of the shortened driving distance. Note, however, that the simulations supporting these results were limited to repetitions of identical drive cycles. It is possible that drive cycle variation (e.g., an urban followed by a highway followed by an urban pattern) may impact this conclusion.

As PHEV technology evolves, energy management strategy will become increasingly important. It will be used to ensure satisfactory battery life, maximize petroleum displacement, gain performance improvement, and manage vehicle thermal and emissions transients. NREL's future work will apply optimization to more varied driving scenarios and include aspects beyond fuel displacement in the objective function.

For more extensive discussion of this topic, please refer to sections 4.1, 4.2, and 4.3.

### **Summary**

NREL's assessment of PHEV technology has added to the body of knowledge and continues the Vehicle Systems Analysis team's long history of timely, innovative, objective, and quality contributions to advanced vehicle technology development. The President's Advanced Energy Initiative defines the goal of developing a plug-in hybrid vehicle with 40 miles of electric range as a means of changing the way we fuel our vehicles. The PHEV research completed in FY06 explored this and many other potential PHEV design scenarios. PHEV technology has great potential to transition our nation's transportation energy demand away from petroleum. However, finding ways to address the high component costs and narrow the gap between vehicle design and consumer behavior through technology optimization will be critical to achieving the petroleum displacement potential of PHEVs.

NREL will execute a continuation of its PHEV research in FY07. The goal will be to develop and demonstrate potential solutions to technical barriers identified by past research. Emphasis will be placed on fuel economy and emissions test procedures and reporting methods, real-world travel behavior analysis, exploration of alternative economic scenarios, and engine and emissions control system modeling for PHEV duty cycles. These tasks will contribute to the overall FreedomCAR PHEV research plan in the areas of analysis, research and development, and test and validation. Finally, the team plans to continue strengthening its collaborative relationships with industry colleagues. With NREL's contributions and the contributions of others, the auto industry and the U.S. Department of Energy can lead to way toward widespread introduction of PHEV technology.

# Section 1

## **Plug-In Hybrid Electric Vehicle Fuel Economy Reporting Methods**

PHEVs differ significantly from existing vehicles. They consume two fuels (petroleum and electricity) at rates that depend on the distance driven and the aggressiveness of the cycle. The Society of Automotive Engineers J1711 Recommended Practice, created in 1999, provides the fundamentals for measuring fuel economy of off-vehicle charge-capable vehicles (i.e., plug-in hybrids and electric vehicles). Seven years later, with a much better understanding of how PHEVs will likely operate, some improvements to the original procedure are recommended. The team's specific recommendations are:

- Report gasoline and electricity consumption separately, which allows the reported results to be used for vehicle operating cost comparisons, fuel consumption, and CO<sub>2</sub> emissions estimates.
- Revise the end-of-test criteria to more accurately determine the distance driven in charge-depleting mode, fully capture the petroleum displacement potential of longer-range PHEVs, and improve the reporting accuracy for short-range PHEVs.
- Assume that vehicles will be fully charged once per day because there is an economic incentive for consumers to recharge their vehicles at least once per day, if not more often.

The recommended improvements to the fuel economy reporting methods have been adopted in our analyses, and the team intends to work with other labs and regulatory agencies to enact similar improvements in their procedures. The analysis also identified the need to develop a new utility factor relationship, based on the best available travel survey data, and to explore the implementation of a driving-type specific utility factor to account for the fact that most short-distance travel will be urban in nature and most long-distance travel will be highway in nature. Finally, it has been determined that the current Environmental Protection Agency certification cycle adjustment factors provide an inaccurate prediction of real-world PHEV consumption and should also be revised.

For a more detailed discussion of this effort, please refer to sections 1.1 and 1.2.

# Section 1.1

**Title:** “Measuring and Reporting Fuel Economy of Plug-In Hybrid Vehicles”

**Type:** Presentation

**Authors:** Jeff Gonder and Andrew Simpson

**Date:** Feb. 1, 2006

**Conference or Meeting:** Presented to the Vehicle Systems Analysis Technical Team

**Abstract:** Identifies modifications to the SAE J1711 Recommended Practice to better represent the fuel economy and electric consumption of PHEVs



# Measuring and Reporting Fuel Economy of Plug-in Hybrid Electric Vehicles

Jeff Gonder

Andrew Simpson, Tony Markel,

Aaron Brooker and Michael O'Keefe

National Renewable Energy Laboratory

February 1, 2006



## Challenges of PHEV Fuel Economy Reporting

- Two fuel sources
- Relative consumption of each fuel depends on duty cycle
  - distance driven between recharge events
  - urban, highway, high-speed
- Must enable stakeholders to make comparisons with other vehicles



## Stakeholder Perspectives

- Motorists
  - operating cost; comparison shopping
- Policymakers/Government
  - national petroleum impact
- Environmentalists
  - national CO<sub>2</sub> production
- Manufacturers
  - benchmarking; certification procedures

3



## Misleading PHEV Fuel Economy Reporting

Non-Standardized Testing of Prototype Vehicle

- Cannot compare performance with other vehicles
  - drive cycles not standardized
  - driving distance not weighted

### **E.g. – EnergyCS reports for *EDrive Prius*\***

- 50-60 miles “boosted driving” at 100-150 mpg
- “200 mpg possible...most users will get 100 mpg”
- “7200 Wh usable battery window”
- no charging → ~50 mpg (normal Prius)

4

\* <http://www.energycs.com/Edrive-FAQ.html>



## Recommendations

- Use modified SAE J1711 Recommended Practice
- Report gasoline & electricity consumption separately
  - gasoline equivalency does not support range of stakeholder perspectives
- Emphasize annual cost for comparison
  - current approach on FuelEconomy.gov

5



# SAE J1711

*Recommended Practice for Measuring  
Fuel Economy of Hybrid Electric Vehicles*

6





# Overview

- Vehicle Classifications
  - Off Vehicle Charge Capable (OVC-capable)
  - Not Off Vehicle Charge Capable
- Test Types
  - Partial Charge Test
  - Full Charge Test
- Operating Modes
  - Hybrid
  - Conventional
  - EV
- Driving Profiles
  - UDDS
  - Highway
  - US06
  - SC03

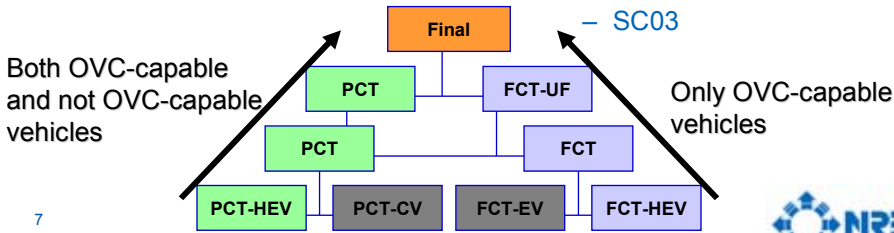

7



## “Partial Charge Test” (PCT) Charge Sustaining (CS) Operation

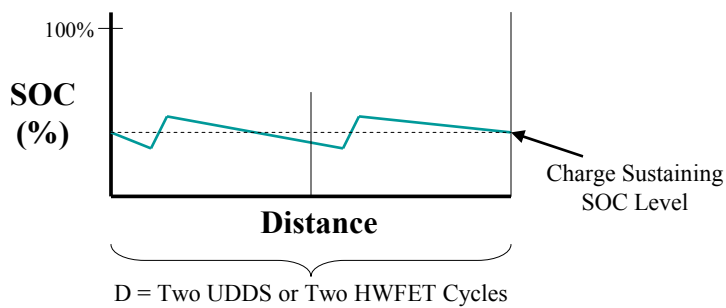

$$mpg_{CS} = \frac{D}{gasoline}$$

8



## “Full Charge Test” (FCT)

### Charge Depleting (CD) Operation

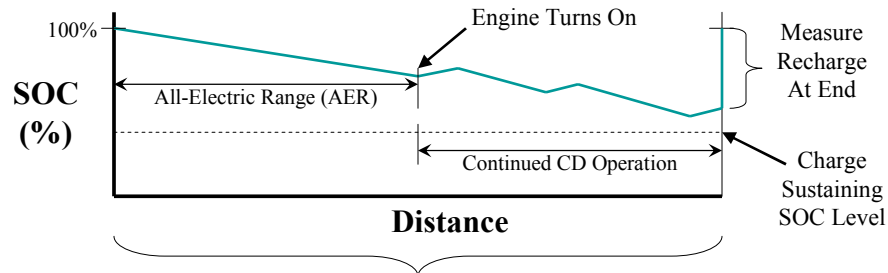

**D = Four UDDS or Three HWFET Cycles (~30 miles)**

**(if no engine on in first 30 miles continue to run cycles until it does turn on)**

$$mpg_{CD} = \frac{D}{\text{gasoline} + \frac{\text{elec\_energy}}{33.44kWh / gal}}$$

9



## Weighting with National Driving Statistics

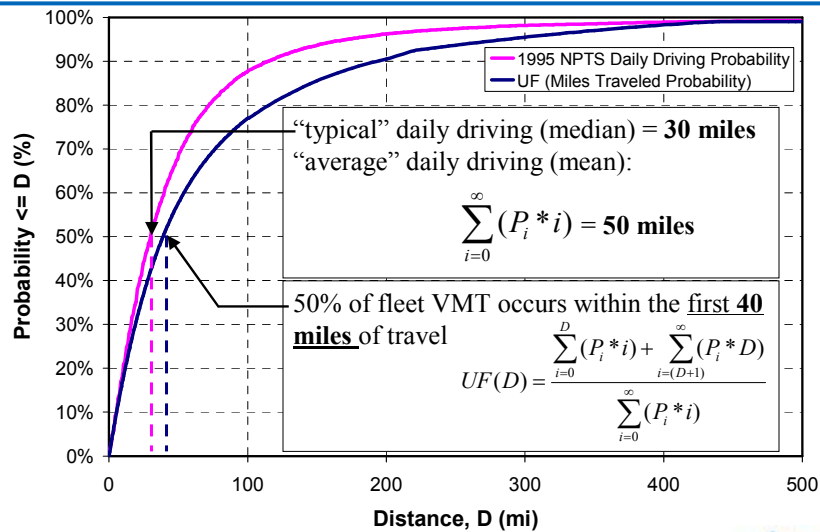

**10 Use Utility Factor (UF) Miles Weighting**



## Utility Factor Applied to FCT Fuel Economy

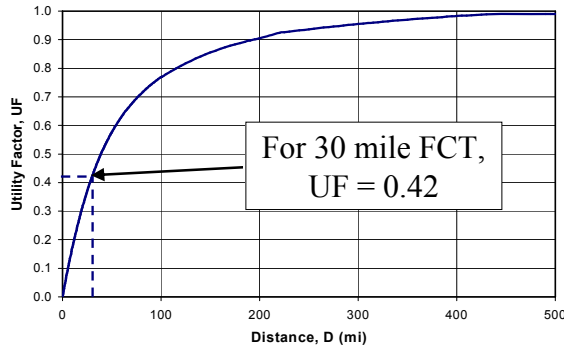

42% of fleet VMT occurs within the first 30 miles of travel

$$mpg_{CD,UF} = \frac{1}{\frac{UF}{mpg_{CD}} + \frac{(1-UF)}{mpg_{CS}}}$$

11



## Final Steps

- Charging frequency assumption
  - once every two days

$$mpg_{cycle} = \frac{2}{\frac{1}{mpg_{CD,UF}} + \frac{1}{mpg_{CS}}}$$

- Composite fuel economy
  - no discussion in SAE J1711
  - assume retain 55/45% weighted harmonic average for city/highway

12



## Important Points from SAE J1711

- Fuel consumption measured in all modes
  - CD fuel consumption alone overstates mpg
  - includes accounting of electricity usage
- Utility Factor
  - properly accounts for and weights all trip lengths
  - necessary for extrapolation to national benefits

13



## Recommended Improvements to SAE J1711

14



## Improvement 1 Report Electricity Separately

- Problem: Energy Equivalence Method does not satisfy stakeholder perspectives
- Solution: Report mpg, Wh/mi & annual operating cost

Example PHEVs*	PHEV5	PHEV30
PCT Results	50 mpg	50 mpg
FCT Results	30 mi, 0.5 gal, 1.2 kWh	30 mi, 0.15 gal, 5 kWh
J1711	51.1 mpg, \$631/yr	55.9 mpg, \$577/yr
J1711 rev. 1	51.8 mpg, 8.4 Wh/mi, \$634/yr	59.3 mpg, 35.0 Wh/mi, \$591/yr

15 \* Assumptions: Gas = \$2.15/gal; Electricity = \$0.09/kWh; Annual Miles = 15,000 (per EPA annual cost calculation)



## Improvement 2 Determination of UF Weighting Distance

E.g. –PHEV5 and PHEV30 UDDS Scenarios:

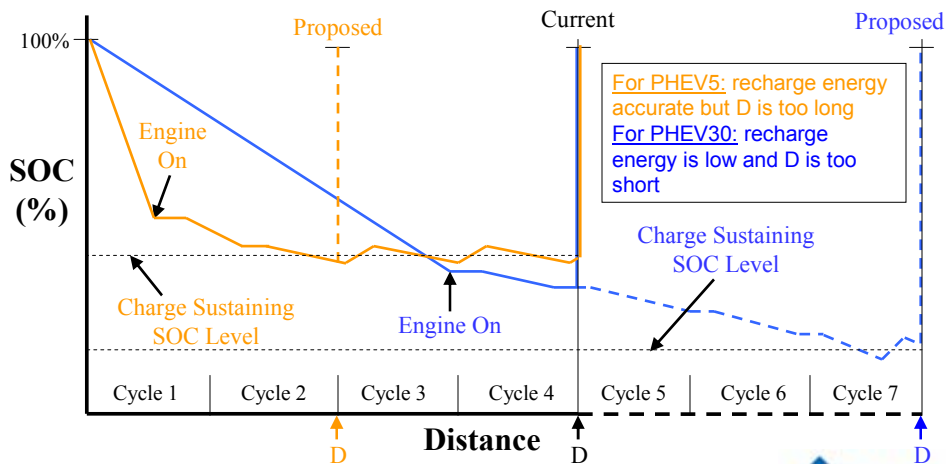

16



## Improvement 2

### Determination of UF Weighting Distance

- Problem: CD distance not accurately captured
- Solution: End FCT test at the end of the cycle in which CS SOC is observed
  - most significant for PHEVs with larger batteries

Example PHEVs*	PHEV5	PHEV30
<b>PCT Results</b>	50 mpg	50 mpg
<b>FCT Results</b>	30 mi, 0.5 gal, 1.2 kWh	30 mi, 0.15 gal, 5 kWh
<b>Revised FCT</b>	15 mi, 0.2 gal, 1.2 kWh	52.5 mi, 0.3 gal, 7.2 kWh
<b>J1711 rev. 1</b>	51.8 mpg, 8.4 Wh/mi, <b>\$634/yr</b>	59.3 mpg, 35.0 Wh/mi, <b>\$591/yr</b>
<b>J1711 rev. 1+2</b>	52.1 mpg, 9.6 Wh/mi, <b>\$632/yr</b>	63.3 mpg, 40.5 Wh/mi, <b>\$564/yr</b>

17 \* Assumptions: Gas = \$2.15/gal; Electricity = \$0.09/kWh;  
Annual Miles = 15,000 (per EPA annual cost calculation)



## Improvement 3

### Change Charging Frequency Assumption to Once/Day

- Problem: Assumes recharge every other day
- Solution: Assume charge daily
  - economic incentive to charge
  - could charge multiple times per day

Example PHEVs*	PHEV5	PHEV30
<b>PCT Results</b>	50 mpg	50 mpg
<b>Revised FCT</b>	15 mi, 0.2 gal, 1.2 kWh	52.5 mi, 0.3 gal, 7.2 kWh
<b>J1711 rev 1+2</b>	52.1 mpg, 9.6 Wh/mi, <b>\$632/yr</b>	63.3 mpg, 40.5 Wh/mi, <b>\$564/yr</b>
<b>J1711 rev. 1+2+3</b>	54.3 mpg, 19.2 Wh/mi, <b>\$619/yr</b>	86.4 mpg, 80.9 Wh/mi, <b>\$482/yr</b>

18 \* Assumptions: Gas = \$2.15/gal; Electricity = \$0.09/kWh;  
Annual Miles = 15,000 (per EPA annual cost calculation)



## Open Issue: Driving Type by Daily Distance

- Currently same procedure used for both City & Highway tests, but...
  - CD operation likely to include more short city trips
  - CS operation likely to include more long highway trips
- Need additional national data
  - for now, keep same approach for each
  - use future data to adjust procedures

19



## Conclusions

- Current SAE J1711 recommended practice provides guideline for consistent reporting of hybrid vehicle fuel economy for a range of vehicle types
- Revisions needed to,
  - fully satisfy the needs of stakeholders
  - more accurately report PHEV performance

20



## Summary of Improvements to J1711

Example PHEVs*	PHEV5	PHEV30
<b>J1711 Original Result</b>	51.1 mpg, \$631/yr	55.9 mpg, \$577/yr
Keep electricity separate	51.8 mpg, 8.4 Wh/mi, \$634/yr	59.3 mpg, 35.0 Wh/mi, \$591/yr
Capture all CD operation	52.1 mpg, 9.6 Wh/mi, \$632/yr	63.3 mpg, 40.5 Wh/mi, \$564/yr
<b>Daily Charging (New Final Result)</b>	54.3 mpg, 19.2 Wh/mi, \$619/yr	86.4 mpg, 80.9 Wh/mi, \$482/yr

In DOE and Industry's best interest to provide useable fuel economy values

21 \* Assumptions:  $\text{mpg}_{\text{CS}} = 50 \text{ mpg}$ ; Gas = \$2.15/gal; Electricity = \$0.09/kWh; Annual Miles = 15,000 (per EPA annual cost calculation)



## Next Steps

- Revive SAE J1711 Working Group
  - NREL provided analysis to initial recommended practice development
  - ANL was liaison between industry working group and EPA and CARB
- Share recommendations with EPA and others

22





# Section 1.2

**Title:** “Measuring and Reporting Fuel Economy of Plug-In Hybrid Electric Vehicles”

**Type:** Paper

**Authors:** Jeff Gonder and Andrew Simpson

**Date:** October 2006

**Conference or Meeting:** Published at the 22nd International Battery, Hybrid, and Fuel Cell Electric Vehicle Symposium and Exposition

**Abstract:** Identifies modifications to the SAE J1711 Recommended Practice to better represent the fuel economy and electric consumption of PHEVs

# MEASURING AND REPORTING FUEL ECONOMY OF PLUG-IN HYBRID ELECTRIC VEHICLES<sup>1</sup>

JEFFREY GONDER

National Renewable Energy Laboratory (NREL)

ANDREW SIMPSON

National Renewable Energy Laboratory (NREL)

## Abstract

Plug-in hybrid-electric vehicles (PHEVs) have recently emerged as a promising alternative technology to dramatically reduce fleet petroleum consumption. However, the fuel economy of many recent prototype and theoretical vehicles has varied widely and often been exaggerated in the press. PHEVs present a significant challenge as compared with conventional vehicle fuel economy reporting because they receive energy from two distinct sources and exhibit widely varying per-mile consumption, based on the drive cycle and distance driven. This paper reviews various techniques used to characterize PHEV fuel economy and discusses the relative merits, limitations, and best uses of each. This review will include a discussion of the SAE J1711 Recommended Practice issued in 1999 and will comment on how recent analysis indicates that the described procedures could be improved for reporting PHEV fuel economy. The paper highlights several critical reporting practices accurately captured by SAE J1711: use of standardized drive cycles; inclusion of charge depleting and charge sustaining operation; and using utility-factor weighting to properly combine the vehicle's operating modes using representative driving statistics. Several recommended improvements to J1711 are also discussed: separate reporting of fuel and electricity use; better determination of the vehicle's charge depleting performance; and application of a once-per-day vehicle charging assumption. As the U.S. Environmental Protection Agency (EPA) considers changes to window-sticker fuel economy test procedures, and the original issuance of SAE J1711 expires, the authors hope to stimulate the necessary discussion and contribute to adoption of consensus reporting metrics. In order for the resulting metrics to be useful, stakeholders must be able to translate the numbers into sound predictions of relative vehicle energy cost, petroleum use, and potential carbon dioxide (CO<sub>2</sub>) production.

**Keywords:** Plug-in Hybrid; Grid-connected HEVs; Vehicle Performance; Energy Efficiency, Energy Consumption; Codes, Standards, Legislation, Regulations; Environmental Impact

## 1 Introduction

A PHEV is a hybrid-electric vehicle (HEV) with the ability to recharge its electrochemical energy storage with electricity from an off-board source (such as the electric utility grid). The vehicle can then drive in a charge-depleting mode that reduces the system's state-of-charge (SOC), thereby using

---

<sup>1</sup> This work has been authored by an employee or employees of the Midwest Research Institute under Contract No. DE-AC36-99GO10337 with the U.S. Department of Energy. The United States Government retains and the publisher, by accepting the article for publication, acknowledges that the United States Government retains a non-exclusive, paid-up, irrevocable, worldwide license to publish or reproduce the published form of this work, or allow others to do so, for United States Government purposes.

electricity to displace petroleum fuel that would otherwise be consumed. PHEVs typically have batteries that are larger than those in HEVs so as to increase the potential for petroleum displacement.

Plug-in hybrid-electric vehicles have recently emerged as a promising alternative to displace a significant fraction of vehicle petroleum consumption with electricity. This potential derives from several factors. First, PHEVs are potentially well-matched to motorists' driving habits, particularly the distribution of miles traveled each day. Second, PHEVs can build off the success of production HEVs in the marketplace. Finally, PHEVs are very marketable in that they combine the beneficial attributes of HEVs and pure battery electric vehicles (BEVs) while simultaneously alleviating the disadvantages of each. As a result, PHEVs have the potential to come to market, penetrate the fleet, and achieve meaningful petroleum displacement relatively quickly. Few competing technologies offer this potential combined rate and timing of reduction in fleet petroleum consumption [1].

Plug-in hybrid-electric vehicles are typically characterized by a "PHEV $x$ " notation, where " $x$ " generally denotes the vehicle's All-Electric Range (AER) – defined as the distance in miles that a fully charged PHEV can drive on stored electricity before needing to operate its engine. The California Air Resources Board (CARB) uses the standard Urban Dynamometer Driving Schedule (UDDS) to measure the all-electric capability of PHEVs and provide a fair comparison between vehicles [2]. According to this definition, a PHEV20 can drive 20 all-electric miles (32 kilometers) on the test cycle before the first engine turn-on. However, this all-electric definition fails to account for PHEVs that might continue to operate in charge-depleting mode after the first engine turn-on.

To better capture the range of PHEV control strategies and configurations, the authors of this paper use a different definition of PHEV $x$  that is more-appropriately related to petroleum displacement. Under this definition, a PHEV20 contains enough useable energy storage in its battery to displace 20 miles of petroleum consumption on the standard test cycle. Note that this definition is not meant to imply all-electric capability because the vehicle operation will ultimately be determined by component power ratings, the vehicle's control strategy, and the nature of the actual in-use driving cycle.

The key limitation of the PHEV $x$  designation is that it is a *relative metric* that only describes potential petroleum displacement relative to the same vehicle operating in charge-sustaining mode. It does not provide information about absolute vehicle fuel economy. For example, a PHEV20 sedan may achieve 40 miles per gallon (mpg), or 5.9 liters per 100 kilometers (L/100 km) in charge-sustaining operation, whereas a PHEV20 SUV may only achieve 25 mpg (9.4 L/100 km), but this is not captured by the PHEV $x$  metric. Furthermore, a fully-charged all-electric PHEV20 uses no petroleum over a 20-mile trip, leading to the impressive result of infinite miles-per-gallon (0 L/100 km) of petroleum use. Such a result is clearly helpful in marketing PHEVs, but does not provide much information about real-world potential because in reality motorists drive a variety of distances – some short, some long. An objective method is clearly needed for evaluating and reporting PHEV fuel economy, so as to avoid exaggerated claims and generate a vehicle rating that translates in some way to expectations for the real-world vehicle performance.

The reader should note that this paper will emphasize imperial units (miles and gallons for driving distance and gasoline usage, respectively) and fuel *economy* rather than *consumption* to be consistent with U.S. Government regulatory standards. Also note that, although this paper was written primarily from a fuel economy perspective (with little discussion of emissions measurement), these recommended procedures for PHEV testing and reporting are designed for suitable application to both fuel economy and emissions measurements.

## 2 PHEV fuel economy reporting methods

Determining a "fuel economy rating" for PHEVs presents a particular challenge as compared with other vehicle technologies because the motive power for the vehicle is derived from two distinct sources: a chemical fuel (typically gasoline) and electricity. The relative consumption of each fuel depends greatly on the duty cycle over which the PHEV operates. As with other vehicles, the type of

driving (urban, highway, high speed, etc.) is a very important factor, but more important to PHEVs is the distance driven between vehicle recharging events. In addition to appreciating the factors influencing fuel vs. electricity consumption, the presence of two energy sources presents a challenge in providing a rating comparable to vehicles using a single mile-per-gallon economy or liter-per-100 kilometers consumption value.

One approach would be to report only the fuel use of the vehicle. This method captures the petroleum consumption impact, but fails to account for the impacts and costs of the additional electricity consumption. Alternatively, the fuel and electricity use can be combined into a single metric that makes assumptions about the equivalent values of the two energy forms. One example is the commonly used energy-equivalency of gasoline and electricity (1 gallon [gal] = 33.44 kilowatt-hours [kWh]), which leads to a metric that accounts for both, but fails to account for differences in the supply-chain efficiency of each. Even if a different energy-equivalence factor is used to account for supply-chain efficiencies, it does not account for likely differences in the primary energy source for each supply chain. One megajoule of coal (for electricity) may have the same primary energy content as one megajoule of crude oil (for gasoline), but these sources are certainly quite different from an economic, environmental, and geopolitical perspective. Other examples of equivalency factors include cost-equivalency factors (e.g., 1 gal @ \$3/gal = 30 kWh @ \$0.1/kWh) and CO<sub>2</sub> emissions-equivalency factors. However, all metrics based on equivalency factors suffer the disadvantage of not providing useful information about net petroleum consumption impact.

Ultimately, there are a variety of stakeholder perspectives that must be addressed when devising a method for fuel economy reporting. Motorists may be primarily concerned with vehicle operating costs and therefore may want a metric that conveys the magnitude of those costs. On the other hand, policymakers and environmentalists may be primarily concerned with national petroleum impact and CO<sub>2</sub> production levels and may want a metric that can be extrapolated to the fleet level. Vehicle manufacturers, however, are obliged to focus on benchmarking and certification procedures and will also want a metric that is well-suited to this purpose.

The authors argue that the measurement technique ultimately selected must capture specific standardized performance aspects to accurately evaluate the tested vehicle with respect to annual operating costs, national petroleum impact, and CO<sub>2</sub> production. Furthermore, the testing to obtain the performance ratings must be conducted over consistent and representative standardized driving profiles, with appropriate weightings applied to account for typical driving distances and to make comparisons with other vehicle technologies possible.

### **3 SAE J1711 Recommended Practice**

While the various reporting approaches discussed in the previous section have been used by a variety of individuals for particular applications or analyses, the most formalized PHEV reporting procedure to date appears to be contained within the Society of Automotive Engineers (SAE) J1711 *Recommended Practice for Measuring the Exhaust Emissions and Fuel Economy of Hybrid-Electric Vehicles* [3]. Originally issued in 1999, the document seeks to provide a technical foundation for reporting procedures applied to a range of HEV designs, including those with “Off-Vehicle-Charge” (OVC) capability (i.e., PHEVs). Figure 1 presents a general overview of the steps in SAE J1711 that build to determining a final fuel economy rating over a particular test cycle. The specific test cycles addressed in the document include the UDDS and the Highway Fuel Economy Test (HWFET), which the EPA use for light-duty fuel economy testing.

Non-OVC-capable conventional HEVs would only complete the steps on the left side of Figure 1, whereas PHEVs follow the steps from both sides of the figure. The Partial-Charge Test (PCT) is designed to measure the vehicle’s performance in a charge-neutral hybrid operating mode, such as after a PHEV has depleted its energy storage system (ESS) to the desired charge-sustaining operating level. The Full-Charge Test (FCT) measures the vehicle’s performance when the initially fully-charged ESS is permitted a net discharge through the course of the test cycle. The bottom row in

Figure 1 indicates the provisions in J1711 to account for user-selectable Conventional Vehicle (CV) and Electric Vehicle (EV) operating modes. However, the test procedure discussion in this paper assumes that the PHEV is only operated in a default/hybrid operating mode. The remaining rows in the figure follow the steps through measuring the results of the PCT and FCT, applying a Utility Factor (UF) weighting to the FCT results, and then combining together the PCT and the weighted FCT results by making an assumption about how frequently the vehicle will be recharged. The remainder of this section will briefly describe each of these steps.

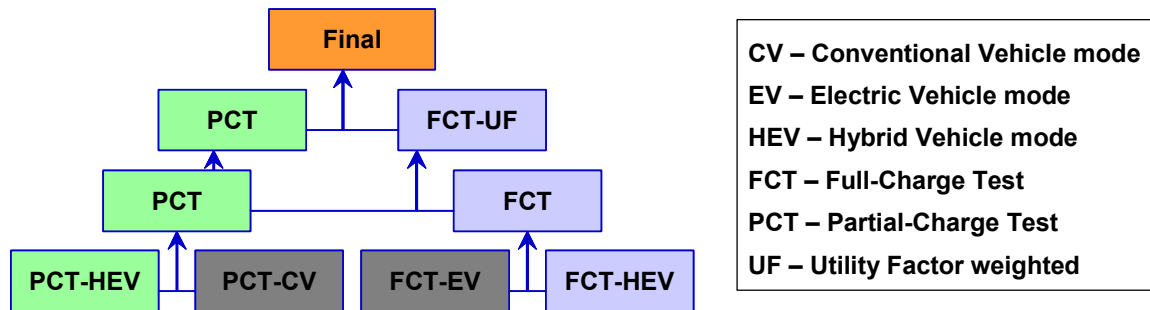

Figure 1: Overview of J1711 approach for determining “final” PHEV fuel economy for a test cycle based on Partial-Charge Test (PCT) and Full-Charge Test (FCT) results

Figure 2 illustrates an example of how the ESS SOC may vary over the course of the PCT. While the instantaneous SOC may move up and down during the test, the final SOC should return to roughly the same level as the initial SOC at the start of the test. The PCT fuel economy is calculated by the following equation, where “D” is the test distance in miles, “ $V_{fuel}$ ” is the volume of fuel consumed in gallons, and “ $mpg_{CS}$ ” is taken to be the charge-sustaining mile-per-gallon rating.

$$mpg_{CS} = \frac{D}{V_{fuel}}$$

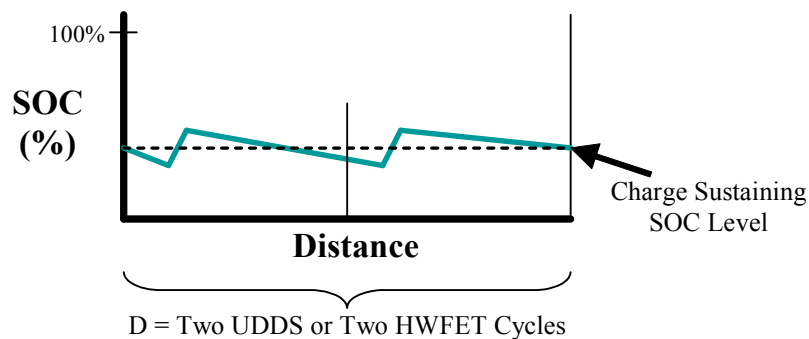
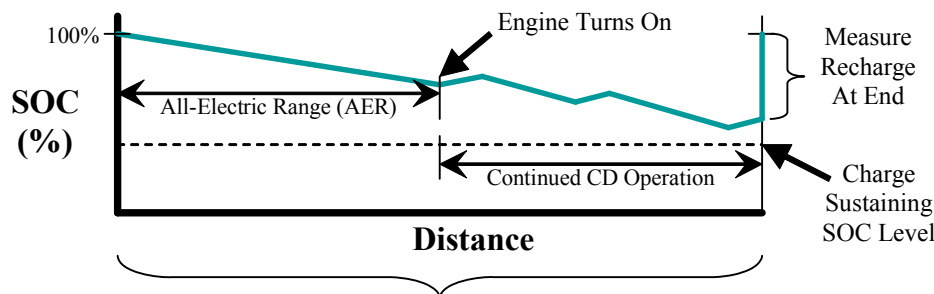

Figure 2: PCT to measure Charge-Sustaining (CS) vehicle fuel economy; illustrated with application to the UDDS or HWFET test cycles

Figure 3 provides a similar example of how SOC may vary over the course of the SAE J1711 FCT. The SOC begins the cycle at 100% and decreases as the vehicle is driven electrically. The distance traveled up until the PHEV engine turns on is recorded as the vehicle’s All-Electric Range (as defined in the introduction to this paper) for the particular test cycle. Following this initial engine turn-on, the vehicle may continue operating in a Charge-Depleting (CD) mode with the engine and ESS/motor working together in a blended manner to propel the vehicle. For the two principal test cycles, the FCT is terminated after four repetitions of the UDDS or three repetitions of the HWFET. However, if the engine has not turned on at that point, the cycles continue repeating until it does turn on. At the conclusion of the test, the ESS is fully recharged using off-board electricity, and the required electrical charging energy is recorded. The following equation is used to calculate the CD mile-per-gallon rating, “ $mpg_{CD}$ ,” as determined by the SAE J1711 FCT. The new terms in this equation are “ $E_{charge}$ ,” the required electrical recharge energy in kilowatt-hours, and “ $E_{gasoline}$ ,” a constant equal to 33.44 kWh/gal

representing the energy content of a gallon of gasoline. Note that this approach converts the electrical recharge energy into an energy-equivalent volume of gasoline to add to the actual volume of fuel consumed.

$$mpg_{CD} = \frac{D}{V_{fuel} + \frac{E_{charge}}{E_{gasoline}}}$$



**D = Four UDDS or Three HWFET Cycles (~30 miles)**  
**(if no engine on in first 30 miles continue to run cycles until it does turn on)**

Figure 3: FCT to measure Charge-Depleting (CD) fuel economy, illustrated with application to the UDDS or HWFET test cycles

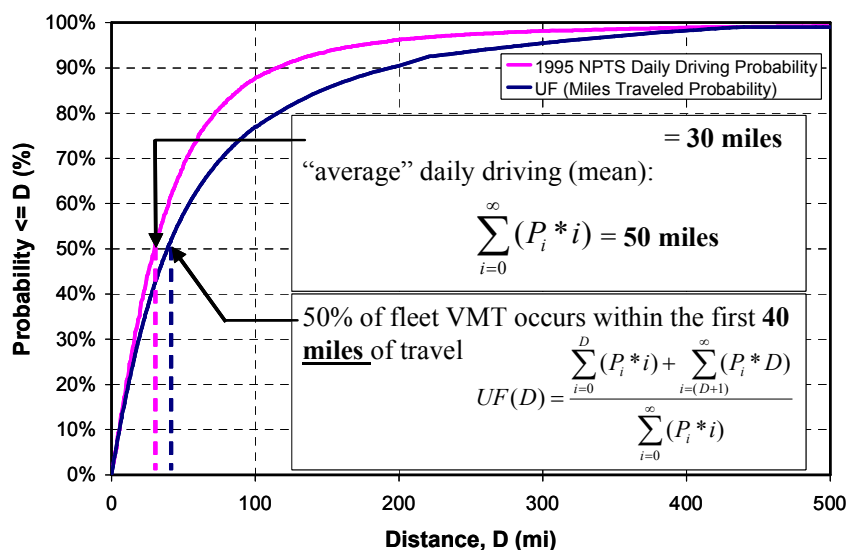

Figure 4: Illustration of Utility Factor (UF) weighting with U.S. national driving statistics

The next key step in SAE J1711 is to weight the FCT result with national driving statistics. Again, because of the focus on U.S. standards, the weighting data is taken from information on U.S. driving behavior. The purpose of the weighting is to determine on aggregate how much of a vehicle’s driving is expected to occur in its CD mode vs. in its CS mode. Figure 4 demonstrates how the appropriate weighting factor is determined. The top line in the figure represents the daily driving probability distribution determined by the 1995 National Personal Transportation Survey (NPTS) conducted in the United States. For each distance, “D,” given along the x-axis, the corresponding point on the y-axis indicated by the curve is the probability that a vehicle’s total daily driving will be less than or equal to D. The point at which the NPTS probability curve crosses 50% is the median or “typical” daily driving distance of 30 miles. However, because longer trips consist of more driving miles, the average daily driving distance is greater – 50 miles as given by the top equation in Figure 4, where “i” is the mileage increment for driving statistics in steps of 1 mile and “P<sub>i</sub>” is the probability that a vehicle will be driven i miles per day. The utility of a CD operating mode to the vehicle fleet must be calculated

on a miles-driven probability basis rather than a “typical vehicle” driving basis because fuel consumption is related to total driven miles, and the 50% of vehicles with daily driving distances greater than the median account for a larger portion of all driven miles. The bottom equation in Figure 4 determines utility on a miles-driven basis, including in the utility calculation all miles for vehicles with daily driving less than the CD distance, as well as the initial miles for vehicles with daily driving greater than the CD distance. The second curve shows the resulting UF calculation as a function of D. For this curve, the interpretation of the 50% probability crossing point is that 50% of fleet Vehicle Miles Traveled (VMT) occurs within the first 40 miles of daily driving.

In SAE J1711, the FCT distance used to determine  $mpg_{CD}$  is roughly 30 miles (assuming four UDDS cycles or three HWFET cycles). The UF value corresponding to this distance is 0.42, which would be used in the following equation to calculate the UF-weighted CD mile-per-gallon rating: “ $mpg_{CD,UF}$ .”

$$mpg_{CD,UF} = \frac{1}{\frac{UF}{mpg_{CD}} + \frac{(1-UF)}{mpg_{CS}}}$$

The final step in SAE J1711 for calculating the cycle fuel economy, “ $mpg_{cycle}$ ,” for a PHEV is to assume the vehicle is equally likely to be driven in a UF-weighted CD mode as to be driven in a CS mode. This is similar to assuming that the vehicle is equally likely to be charged daily as to never be charged at all, or that the vehicle is charged on average once every 2 days. The equation below applies this equal probability assumption.

$$mpg_{cycle} = \frac{2}{\frac{1}{mpg_{CD,UF}} + \frac{1}{mpg_{CS}}}$$

Because the above-described approach only determines the fuel economy for specific test cycles, it is assumed that a composite PHEV fuel economy number would have to be obtained by employing the EPA’s multi-cycle weighting methodology. The current-status EPA approach would be to apply a 55/45% weighted harmonic average to the results of the city/highway test cycles.

## 4 Important points and recommended changes to SAE J1711

The SAE J1711 Recommended Practice addresses several of the key issues necessary for properly measuring PHEV fuel economy. In particular, the document correctly recognizes that vehicle performance must be evaluated in both CD and CS operating modes, and that both fuel and net electricity consumption must be included. To account for the utility of CD operation, SAE J1711 also correctly applies a UF approach to account for the distribution of daily driving behavior that is weighted based on daily distances driven. This step is necessary to determine a PHEV fuel economy rating that is comparable on a national benefits scale to other vehicles’ ratings (again assuming that national driving statistics were used to generate the UF curve).

There are also several aspects of SAE J1711 that the authors recommend modifying. Three of the most important changes include keeping fuel and electricity consumption separated, better determining the CD operating distance for UF weighting, and changing the charging frequency assumption from once every other day to once daily. The remainder of this section will discuss each of these recommendations in more detail and provide an example of their relative impact.

### 4.1 Recommendation 1: Report electricity separately

As discussed in section 2 of this paper, the energy equivalence method of treating electricity consumption as if it were gasoline does not support the needs of stakeholders that use the vehicle’s fuel economy rating. A more useful approach to that currently suggested by SAE J1711 would be to

present a fuel economy and electricity consumption rating for the vehicle (such as providing a watt-hour-per-mile (Wh/mi) value in addition to the mile per gallon number). When combined with a distance driven over a period of time (that is representative of the typical daily distance distribution), these two numbers would provide an estimate of the volume of fuel used and the electrical charging energy that went into the vehicle over that operating period. A stakeholder who knew a baseline vehicle’s fuel consumption and the production mix of a certain region’s electrical utility could then take these separate fuel and electrical energy values to determine petroleum and CO<sub>2</sub> impact. For the benefit of consumers who are typically most interested in their vehicle’s total energy cost (including fuel and electricity use), this rating approach could also consider average gasoline and electricity prices along with a typical annual driving distance to estimate a representative energy cost comparable from vehicle to vehicle.

Table 1 provides an example of the impact this revision to J1711 would have on two hypothetical PHEVs. The assumptions used to generate the annual energy cost estimates for all the tables in this paper were fuel and electricity costs of \$2.50/gal and \$0.09/kWh, respectively, and an annual driving distance of 15,000 miles (a typical annual VMT for U.S. drivers). Note also that all of the annual cost estimates are for illustration purposes only, as they are extrapolated from hypothetical test results over one cycle only. As the results in Table 1 illustrate, this change (to report electricity separately) does not by itself produce a large change in the energy cost estimate, but it does provide more accurate and useful information about the distribution of energy use between gasoline and electricity.

Table 1: Example impact of Recommendation 1 – reporting electricity separately\*

Example PHEVs	<u>PHEV5</u>	<u>PHEV30</u>
PCT Results	50 mpg	50 mpg
FCT Results	30 mi, 0.5 gal, 1.2 kWh	30 mi, 0.15 gal, 5 kWh
J1711	51.1 mpg, <b>\$733/yr</b>	55.9 mpg, <b>\$671/yr</b>
J1711 Recommendation 1	51.8 mpg, 8.4 Wh/mi, <b>\$735/yr</b>	59.3 mpg, 35.0 Wh/mi, <b>\$679/yr</b>

\*Assumes \$2.50/gal fuel, \$0.09/kWh electricity and 15,000 miles/year

#### 4.2 Recommendation 2: Determination of utility factor (UF) weighting distance

A second recommended change to the existing J1711 reporting procedure would be to improve determination of the CD operating distance for UF weighting. Figure 5 provides an example of the SOC profile during the UDDS FCT (as described in Figure 3) for the two example PHEV5 and PHEV30 vehicles in order to demonstrate how the existing procedure could be improved. For both example vehicles, the engine turns on during the first four cycle repetitions, so the existing procedure calls for ending the test after completing the fourth cycle and measuring the recharge energy required. As the figure shows for the PHEV5 vehicle, the ESS SOC drops quickly during the first half of the initial UDDS cycle, and continues to drop at a somewhat slower rate once it begins operating in a blended (engine plus ESS/motor) mode. From partway through the second cycle until the end of the fourth cycle, the PHEV5 operates in a CS mode. For the PHEV30, the ESS discharges during all-electric vehicle operation through the first three cycles, and then continues to discharge at a slower rate during the fourth cycle as the vehicle operates in a blended mode. By the end of the fourth cycle when the existing SAE J1711 approach calls for completing the test, the ESS has not yet reached its CS SOC level. By holding the FCT to the fixed length of four-cycles, the existing J1711 approach actually averages together roughly 50% CD operation and 50% CS operation to obtain the “CD rating” for the PHEV5, and it also does not credit the PHEV30 for its continued CD operation beyond the end of the fourth cycle (instead assuming the CS rating applies to all cycles after the first four).

Instead of fixing the FCT length, the authors recommend ending the FCT after completing the cycle during which the CS SOC is reached. In a practical implementation, this would mean tracking the total Ampere-hour (Ah) discharge from the vehicle ESS and calculating when the manufacturer’s CS



SOC level was reached, or determining when the net ESS Ah change either increases or remains within a tolerance during all or most of one cycle. (The latter approach could result in one full cycle of CS operation included at the end of the FCT, so the following steps could be adjusted accordingly in order to set the UF-weighting distance to only include cycles in which CD operation occurred.) Assuming that it could be determined when the CS operating level was reached, the end of the cycle during which this occurred would be used as the distance, D, in the UF-weighting, and the recharge energy would be measured at this point. As Figure 5 illustrates, the modified FCT would be completed after two cycles for the PHEV5 vehicle and the recharge energy would remain basically the same. For the PHEV30 vehicle, the modified FCT would be extended to seven total cycles and the recharge energy would be greater (accurately reflecting the energy required to return the vehicle from a CS SOC state to fully-charged).

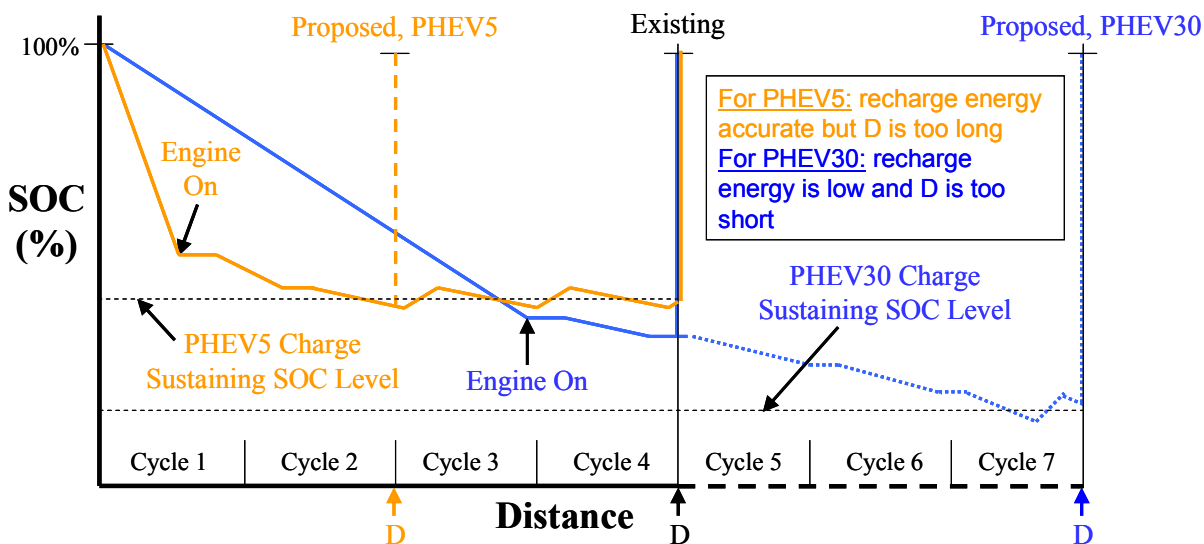

Figure 5: Hypothetical FCT SOC profiles for two example PHEVs over a UDDS cycle test

Table 2 presents an example of the impact this change might have on estimated energy use and cost. The table compares the result of just modifying J1711 with the separate electricity reporting recommendation to the result of using J1711 with separate electricity reporting and a modified FCT to more accurately determine the UF weighting distance. The result of the change is minor for the PHEV5 vehicle, but is noticeable for the PHEV30 vehicle – producing a 5% decrease in the annual energy cost estimate. The impact of the change should be largest for vehicles with a large ESS, for which the existing procedure potentially misses many miles of continued CD operation between the end of the FCT and when the vehicle actually begins CS operation.

Table 2: Example impact of Recommendation 2 – determining UF weighting distance\*

Example PHEVs	<u>PHEV5</u>	<u>PHEV30</u>
PCT Results	50 mpg	50 mpg
Original FCT Results	30 mi, 0.5 gal, 1.2 kWh	30 mi, 0.15 gal, 5 kWh
Revised FCT Results	15 mi, 0.2 gal, 1.2 kWh	52.5 mi, 0.3 gal, 7.2 kWh
J1711 Recommendation 1	51.8 mpg, 8.4 Wh/mi, <b>\$735/yr</b>	59.3 mpg, 35.0 Wh/mi, <b>\$679/yr</b>
J1711 Recommendations 1&2	52.1 mpg, 9.6 Wh/mi, <b>\$733/yr</b>	63.3 mpg, 40.5 Wh/mi, <b>\$647/yr</b>

\*Assumes \$2.50/gal fuel, \$0.09/kWh electricity and 15,000 miles/year

Note that to ensure CS operation follows completion of the FCT, the FCT and PCT could be combined into one single procedure to first measure CD operation and then subsequent CS operation. However, the authors anticipate that comprehensive emissions measurement will still necessitate completion of a

cold-start PCT, and so do not suggest moving away from two separate tests. Note also that the procedure for determining the UF weighting distance implicitly assumes that the average mpg and Wh/mile values can be uniformly applied over the vehicle’s driving up to distance, “D.” In reality, the vehicle will likely consume more electricity and less fuel early on in the cycles, and will shift to consuming more fuel and less electricity as it approaches the distance, “D.” A worthwhile approach to consider for capturing this effect would be to segment the utility factor in whole-cycle increments in order to weight the fuel and electricity use over each individual cycle for determining the total representative energy use estimate. However, the authors do not recommend this more complicated approach because the uncertainty introduced through necessary estimation of the recharge energy required for each cycle could easily offset the improved accuracy over a uniform CD operation assumption. In addition, the uncertainties in the data used to generate the UF curve could be amplified and inadvertently propagated when assigning individual weightings to each incremental cycle segment distance.

### 4.3 Recommendation 3: Changing the charging frequency assumption

The third recommended change to SAE J1711 is fairly simple but can have a large impact on reported energy consumption and cost. As described in section 3, the current approach averages together the UF-weighted CD result (which is intended to approximate once daily charging) and the CS result (which represents no charging). Because no reliable national data exists to predict how often PHEV drivers will plug in their vehicles, the original J1711 task force selected this equal weighting between “plug-in” and “non-plug-in” operation as a placeholder for combining the effects of these two operating modes. However, in the absence of conclusive data to capture expected charging frequency for PHEVs, the authors of this paper assert that once-per-day charging (represented by the UF-weighted CD result) is a better placeholder for combining CD and CS operation. This is because in addition to charging the vehicle either zero or one time per day, the PHEV driver could charge the vehicle multiple times per day (known as “opportunity charging”) whenever parked at a home, work, or other location that had a charging outlet.

Especially during the early years of their introduction into the market, there will likely be a large price increment between a conventional or hybrid and a comparable PHEV. In order to recover some of this initial expense, there will be a large economic incentive for PHEV drivers to take advantage of the significantly lower energy cost to operate the vehicle on electricity rather than on gasoline alone. The relatively small early market penetration levels should also require fairly little utility control over vehicle charging to avoid exacerbating peak daytime electricity demand. This would permit PHEV drivers to act on the incentive to opportunity charge several times daily. Even so, until solid data sets become available to support an average charging frequency assumption greater than once daily (or between 0-1 times per day), once daily charging provides a reasonable placeholder for this frequency assumption. Because of the economic incentive to charge, especially in the initial years of PHEV adoption and test procedure application, this once per day assumption should provide a more accurate placeholder than a once every other day assumption.

Table 3: Example impact of Recommendation 3 – changing the charging frequency assumption\*

Example PHEVs	<u>PHEV5</u>	<u>PHEV30</u>
PCT Results	50 mpg	50 mpg
Revised FCT Results	15 mi, 0.2 gal, 1.2 kWh	52.5 mi, 0.3 gal, 7.2 kWh
J1711 Recommendations 1&2	52.1 mpg, 9.6 Wh/mi, <b>\$733/yr</b>	63.3 mpg, 40.5 Wh/mi, <b>\$647/yr</b>
J1711 Recommendations 1,2&3	54.3 mpg, 19.2 Wh/mi, <b>\$716/yr</b>	86.4 mpg, 80.9 Wh/mi, <b>\$543/yr</b>

\*Assumes \$2.50/gal fuel, \$0.09/kWh electricity and 15,000 miles/year

Table 3 provides the final example results highlighting the impact of adding this third recommended change to the first two. For both example vehicles, the final change causes the reported fuel economy

to increase at the expense of a higher per-mile electricity consumption rating, but ultimately provides an overall reduction in the estimated annual energy cost. The observed impact is again much greater for the PHEV30 with its larger ESS – resulting in a 16% reduction in the annual energy cost estimate.

#### **4.4 Additional discussion**

There are two significant open issues not addressed in SAE J1711 that this document does not examine in detail. The first is the correlation between driving type and driving distance. The current-status UF weighting approach implicitly assumes that the daily distance distribution of the driving represented by a particular test cycle matches the average distribution given by national (U.S.) driving statistics. For instance, with the current two-cycle city and highway EPA approach, the same national driving statistics would determine the combined CD and CS weighting for the UDDS (city driving) and for the HWFET (highway driving) before merging these values into a composite rating (by applying the 55/45% weighting of city/highway driving). This set UF weighting approach for each cycle neglects the fact that shorter city trips are likely to make up a larger fraction of CD operating miles, and longer highway trips are likely to make up a larger fraction of CS operating miles.

If future travel surveys can begin to capture the variation of driving type by daily driving distance, then a unique UF curve could be selected for each cycle. In the mean time, it once again seems most appropriate to maintain application of the uniform UF curve to each cycle evaluated. The EPA's proposed move to a five-cycle procedure [4] will present additional challenges, not the least of which is a dramatically increased burden of up to ten tests in order to complete the PCT and FCT for each cycle. An official revision to J1711 should consider the new procedure EPA officially adopts and balance decisions to improve accuracy with those to avoid excessive testing complexity and cost.

The second challenging issue that will require further examination is how to apply EPA in-use fuel economy adjustment factors to a PHEV. The EPA introduced these adjustment factors in 1984 in an effort to quantify observed reductions in real-world fuel economy below certification cycle test results due to effects such as more aggressive driving and use of accessories (especially air conditioning). This adjustment approach is still in use today, although continued overestimation of in-use fuel economy has prompted the EPA to now consider more dramatic procedure revisions. The current methodology reduces the UDDS and HWFET test results by 10 and 22 percent, respectively, to determine the city and highway fuel economy estimates. However, the same methodology cannot be used to adjust a PHEV's UF-weighted fuel economy and electricity consumption results because the effects that the adjustment factors are supposed to represent (such as more aggressive driving) would be observed prior to performing the UF weighting of CD and CS operation. Specifically, the adjusted cycle could impact the PCT and FCT mile per gallon and watt-hour per mile results, as well as the CD distance used for UF weighting.

One possible approach to apply the EPA adjustment factors to a PHEV would be to reduce the PCT fuel economy in the same manner as would be done for a conventional vehicle, and determine the resulting increase in fuel volume consumed over a CS distance equal to the original (UF weighting) FCT distance. The UF weighting distance for the FCT would then be assumed to remain the same, with the calculated volume of fuel added into the FCT fuel economy result. An alternate approach would be to apply the adjustment factor to the PCT and FCT fuel economy and electricity consumption results, as well as to the CD distance (resulting in a reduced distance to use with the UF weighting curve). Further analysis will be required to determine the validity of either of these approaches. Fortunately, either method would maintain some applicability to the anticipated EPA procedure changes, as the EPA proposal retains a downward adjustment of measured fuel economy results to account for effects impossible to incorporate in laboratory dynamometer testing [4].

## 5 Summary and conclusions

In its present form, the SAE J1711 recommended practice provides useful guidelines for consistent reporting of hybrid vehicle fuel economy across a range of vehicle types. Through application to standard drive cycles and weighting the utility of CD PHEV operation (based on national fleet statistics), J1711 provides a more objective comparison of PHEV performance to that of conventional and HEVs than do other less formalized rating approaches. J1711 nonetheless requires some revision to fully satisfy the needs of stakeholders using the fuel economy rating, and to further improve its accuracy in reporting PHEV performance. Table 4 summarizes the example impacts for the three major recommended changes described in this paper.

Table 4: Summary of example impacts for recommended changes to SAE J1711\*

Example PHEVs	<u>PHEV5</u>	<u>PHEV30</u>
<b>J1711 original result</b>	<b>51.1 mpg, \$733/yr</b>	<b>55.9 mpg, \$671/yr</b>
+ Keep electricity separate	51.8 mpg, 8.4 Wh/mi, \$735/yr	59.3 mpg, 35.0 Wh/mi, \$679/yr
+ Better capture CD distance	52.1 mpg, 9.6 Wh/mi, \$733/yr	63.3 mpg, 40.5 Wh/mi, \$647/yr
+ Assume once daily charging ( <b>New final result</b> )	<b><u>54.3 mpg, 19.2 Wh/mi, \$716/yr</u></b>	<b><u>86.4 mpg, 80.9 Wh/mi, \$543/yr</u></b>

\*Assumes 50 mpg PCT, \$2.50/gal fuel, \$0.09/kWh electricity and 15,000 miles/year

The new results for the modified reporting approach provide a more accurate estimate of the petroleum savings each of these vehicles could provide, which was understated by the original J1711 result. Specifically, the petroleum consumption estimate is reduced by 6% for the PHEV5 and by 35% for the PHEV30. The new results also provide an estimate of the electricity consumption per mile that a typical user could expect the vehicle to achieve. From this more accurate description distinguishing fuel from electricity use, and assuming once daily charging, the results demonstrate a 2% reduction in the annual energy cost estimate for the PHEV5 and a 19% reduction in the annual energy cost estimate for the PHEV30 relative to the original J1711 result. The magnitude of the improved estimates for petroleum use and energy cost are greater for longer distance rated PHEVs because of the potential offered by their larger energy storage systems.

It is in the best interest of all those evaluating the potential benefits of PHEVs to be able to objectively evaluate the technology relative to other vehicles. It should likewise be in the best interest of PHEV advocates to establish and follow consensus PHEV reporting procedures to avoid accusations of providing unfounded “hype” for the technology. In particular, the adopted procedures should characterize PHEV performance over a representative range of driving conditions, including proper weighting of typical vehicle daily driving distances. A discussion of accurate and objective PHEV fuel economy reporting is particularly important in the present context of increasing technical interest in PHEVs, expiration of the original issuance of SAE J1711 and EPA’s proposal to change the agency’s conventional vehicle test procedures. It is the authors’ hope that the issues raised in this paper help stimulate the necessary discussion and contribute to adoption of consensus reporting metrics. As discussed in this paper, for the resulting metrics to be useful, stakeholders must be able to translate the numbers into sound predictions of relative vehicle energy cost, petroleum use, and potential carbon dioxide (CO<sub>2</sub>) production.

## Acknowledgement

The authors would like to acknowledge the programmatic support of the U.S. Department of Energy Office of Energy Efficiency and Renewable Energy FreedomCAR and Vehicle Technologies Program.

## List of symbols and acronyms

AER – all-electric range	BEV – battery electric vehicle
CARB – California Air Resources Board	CD – charge depleting
CO <sub>2</sub> – carbon dioxide	CS – charge sustaining
CV – conventional vehicle	D – distance [miles]
DOE – U.S. Department of Energy	E <sub>charge</sub> – electrical recharge energy
E <sub>gasoline</sub> – gasoline energy content (33.44 kWh/gal)	ESS – energy storage system
EPA – U.S. Environmental Protection Agency	EV – electric vehicle
FCT – Full-Charge Test	HEV – hybrid electric vehicle
HWFET – Highway Fuel Economy Test	i – mileage increment for driving statistics
mpg <sub>X</sub> – mile-per-gallon rating in mode X	OVC – off-vehicle charge
NPTS – National Personal Transportation Survey	PCT – Partial-Charge Test
PHEV – plug-in hybrid electric vehicle	P <sub>i</sub> – probability i miles driven in a day
SAE – Society of Automotive Engineers	SOC – state of charge (of the ESS)
UDDS – Urban Dynamometer Driving Schedule	UF – Utility Factor
V <sub>fuel</sub> – fuel volume consumed [gallons]	VMT – vehicle miles traveled

## References

- [1] Markel, T., O’Keefe, M., Simpson, A., Gonder, J., and Brooker, A. *Plug-in HEVs: A Near-term Option to Reduce Petroleum Consumption*, Milestone Report, National Renewable Energy Laboratory, 2005.
- [2] California Air Resources Board, *California Exhaust Emission Standards and Test Procedures for 2005 and Subsequent Model Zero-Emission Vehicles, and 2002 and Subsequent Model Hybrid Electric Vehicles, in the Passenger Car, Light-Duty Truck and Medium-Duty Vehicle Classes*, California Environmental Protection Agency, 2003.
- [3] Society of Automotive Engineers Surface Vehicle Recommended Practice, *SAE J1711 – Recommended Practice for Measuring Fuel Economy of Hybrid-Electric Vehicles*, Society of Automotive Engineers Publication, Issued March 1999.
- [4] Environmental Protection Agency, *Fuel Economy Labeling of Motor Vehicles: Revisions to Improve Calculation of Fuel Economy Estimates*, 40 CFR Parts 86, 600, EPA: Notice of Proposed Rulemaking, EPA-HQ-OAR-2005-0169.

## Authors



Jeffrey Gonder, Research Engineer, National Renewable Energy Laboratory (NREL), 1617 Cole Blvd; Golden, CO 80401 USA; Tel: 303-275-4462; Fax: 303-275-4415; [jeff\\_gonder@nrel.gov](mailto:jeff_gonder@nrel.gov). Jeff joined the Advanced Vehicle Systems Group at NREL in 2005. His research includes systems analysis of plug-in hybrid electric vehicles and novel hybrid control strategies. Jeff holds a Master’s degree in Mechanical Engineering from The Pennsylvania State University and a Bachelor’s degree in the same subject from the University of Colorado. Prior to joining NREL, Jeff developed fuel cell systems and vehicles at Anuvu Inc. in Sacramento, CA. In graduate school, Jeff researched direct methanol fuel cells and helped lead the Penn State FutureTruck hybrid vehicle competition team.



Andrew Simpson, Vehicle Systems Engineer, National Renewable Energy Laboratory (NREL), 1617 Cole Blvd, Golden CO 80401 USA; Tel: 303-275-4430; Fax: 303-275-4415; [andrew\\_simpson@nrel.gov](mailto:andrew_simpson@nrel.gov). Andrew joined the Advanced Vehicle Systems Group at NREL in 2005 and his current focus is plug-in hybrid-electric vehicles. He holds a Bachelor of Mechanical Engineering (2000) and Ph.D. in Electrical Engineering (2005) from the University of Queensland, Brisbane, Australia. Prior to NREL, Andrew worked as a CFD consultant for Maunsell Australia. He co-founded the Sustainable Energy Research Group at The University of Queensland and was a coordinating member of the University’s “SunShark” solar racing team which competed successfully from 1996-2000.

# Section 2

## Plug-In Hybrid Electric Vehicle Cost and Consumption Benefit Analysis

“Comparing the Benefits and Impacts of Hybrid Electric Vehicle Options,” a report published by the Electric Power Research Institute in July 2001, was a unique study that stands as a comprehensive analysis of hybrid electric vehicle and PHEV technology implementation. NREL contributed vehicle system simulation results to this report. The analysis scope was limited to just a few vehicle scenarios, including conventional, HEV0, PHEV20, and PHEV60. These vehicles were designed to achieve all-electric operation on the urban cycle for the specified distance.

NREL recently developed a rapid design exploration methodology and applied the methodology to an expanded PHEV analysis spectrum that includes PHEVs with a wide range of power and energy capabilities. In particular, the scope included PHEVs with limited all-electric capabilities that are still able to realize tangible petroleum displacement by operating in a “blended” charge-depleting mode.

Key conclusions from the analyses are:

- The PHEV<sub>x</sub> definition should be based on the *energy equivalent all-electric range* of the energy storage system, rather than on actual all-electric range (the distance before first engine turn-on event). The current all-electric range focused definition constrains the PHEV design space and is not necessarily directly related to petroleum displacement.
- The expected petroleum reduction of a PHEV is substantial, but the incremental costs may present a barrier to broad market penetration. A PHEV20 would likely reduce petroleum consumption by 50% but cost \$8,000 more than a conventional vehicle. The PHEV40 would cost \$11,000 more than a conventional vehicle and may reduce petroleum consumption by 62%.
- Data in open literature support an inverse correlation between battery cycle life and cycle depth of discharge. To provide equivalent cycle life performance, the usable state-of-charge window of a short-range PHEV must be significantly less than that of a long-range PHEV. For example, for a 15-year life, a PHEV10 can only use 41% of the capacity, while a PHEV60 may use up to 73% and still achieve battery life targets.
- If PHEVs are to provide a payback relative to a hybrid electric vehicle within 10 years, based on fuel cost savings and purchase cost alone, battery costs must reach long-term, high-volume cost estimates (<\$300/kWh), and gasoline costs must increase to more than \$4/gal. In the absence of both lower battery costs and higher gas prices, alternative value propositions (e.g., government incentives, vehicle-to-grid revenue, battery leases, the value of a “green” image, avoided trips to the gas station, and the feel of electric operation) must be considered to overcome the cost premium of PHEVs.

The analysis thus far has not allowed vehicle platform engineering as a strategy to reduce costs and improve fuel economy. Aerodynamics and vehicle light-weighting will likely have a more pronounced impact on PHEVs than any other configuration. Future analysis will focus on vehicle platform enhancements and their impact on the relative costs and benefits of PHEVs. In addition, design options and alternative business models will be explored to address the high cost of batteries for PHEVs.

For more extensive discussion of this topic, please refer to sections 2.1, 2.2, 2.3, 2.4, and 2.5.

# Section 2.1

**Title:** “Cost/Benefit Analysis of Hybrid-Electric and Plug-In Hybrid-Electric Vehicle Technology”

**Type:** Presentation

**Authors:** Andrew Simpson

**Date:** March 1, 2006 (updated May 2006)

**Conference or Meeting:** Presented to the Vehicle Systems Analysis Technical Team

**Abstract:** Explores the spectrum of PHEV design space with respect to battery options and quantifies the most cost-effective scenarios

## Cost / Benefit Analysis of Hybrid-Electric and Plug-In Hybrid-Electric Vehicle Technology

A presentation to the FreedomCAR Vehicle Systems Analysis Technical Team by

**Andrew Simpson**  
**National Renewable Energy Laboratory**

Presented Wednesday, 1<sup>st</sup> March 2006  
REVISED May 2006

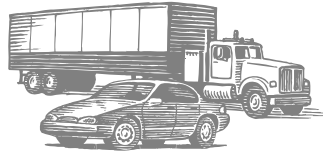

With support from the  
U.S. Department of Energy  
Office of Energy Efficiency and Renewable Energy  
FreedomCAR and Vehicle Technologies Program

### Disclaimer and Government License

This work has been authored by Midwest Research Institute (MRI) under Contract No. DE-AC36-99GO10337 with the U.S. Department of Energy (the "DOE"). The United States Government (the "Government") retains and the publisher, by accepting the work for publication, acknowledges that the Government retains a non-exclusive, paid-up, irrevocable, worldwide license to publish or reproduce the published form of this work or allow others to do so, for Government purposes.

Neither MRI, the DOE, the Government, nor any other agency thereof, nor any of their employees, makes any warranty, express or implied, or assumes any liability or responsibility for the accuracy, completeness, or usefulness of any information, apparatus, product, or process disclosed, or represents that its use would not infringe any privately owned rights. Reference herein to any specific commercial product, process, or service by trade name, trademark, manufacturer, or otherwise does not constitute or imply its endorsement, recommendation, or favoring by the Government or any agency thereof. The views and opinions of the authors and/or presenters expressed herein do not necessarily state or reflect those of MRI, the DOE, the Government, or any agency thereof.



# The Perfect Storm

- Petroleum **consumption** has steadily **increased** while domestic **production** has continued to **decline**
- World oil **production** predicted to **peak** within the next 5-15 years
- Recent increase in **gasoline price** is indicator of **growing tension** between supply and demand

Gasoline price - 200% rise in 8 years!

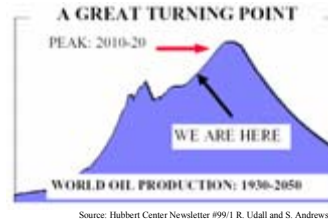
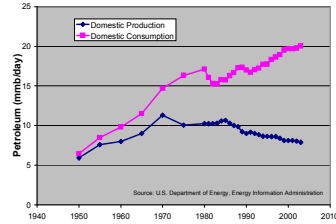
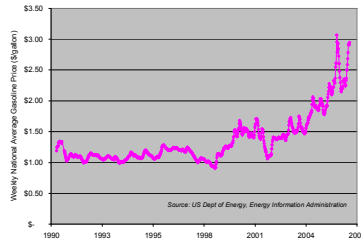

**WHAT'S OUR PLAN?**

3

# Oil Use Reduction with HEVs

Light Duty Fleet Oil Use - Impact of HEVs on Consumption

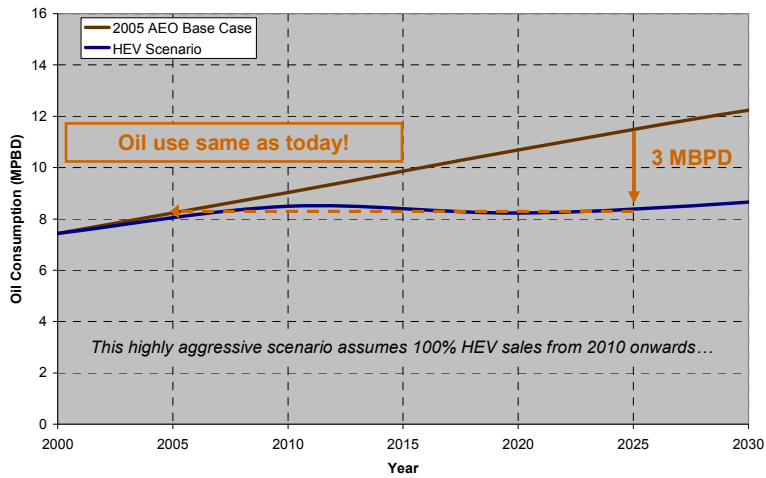

Produced using VISION model, MBPD = million barrels per day

4

## Key Messages

1. There is a very broad spectrum of HEV-PHEV designs.
2. Reduction in per-vehicle fuel consumption via HEVs is limited, whereas PHEVs can reduce per-vehicle fuel use much further.
3. PHEVs have higher powertrain costs than HEVs, but have lower “fuel” costs than HEVs.
4. PHEVs are the most-cost-effective choice in a scenario of projected (low) battery costs and high fuel costs.

5



## Presentation Outline

- Study Objectives
- Potential petroleum reduction from PHEVs
- Simulation of PHEV efficiency and cost
  - Baseline vehicle assumptions
  - Components models (cost, mass, volume, efficiency)
  - Control strategy
- Results
  - Component sizing
  - Fuel Economy
  - Incremental cost
  - Payback scenarios
- Conclusions & Next Steps

6



## Study Objective

Question:  
Under what circumstances do PHEVs  
“make sense”?

Subject to:

- battery energy / PHEV range
- battery power / degree of hybridization (DOH)
- control strategy including SOC/DOD window
- battery chemistry
- fuel prices
- driving habits

7



## Potential Gasoline Savings from Plug-In HEVs

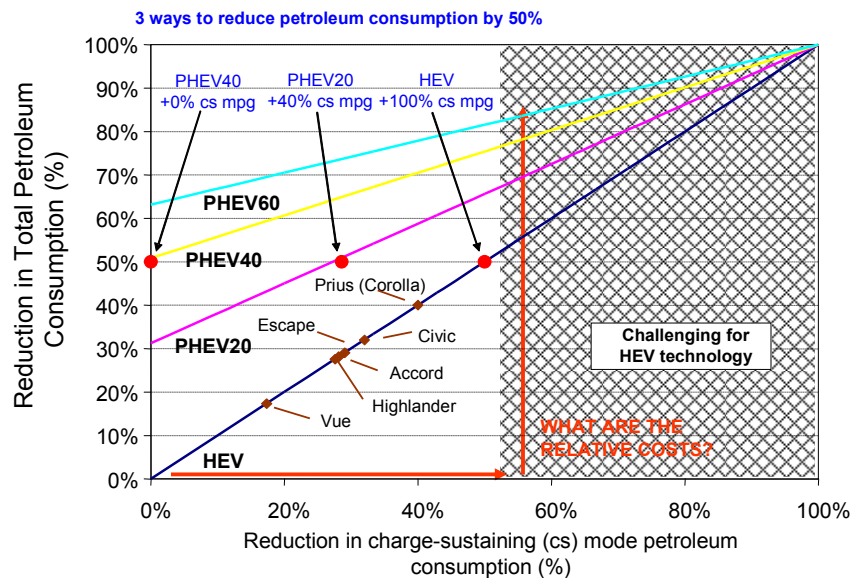

8



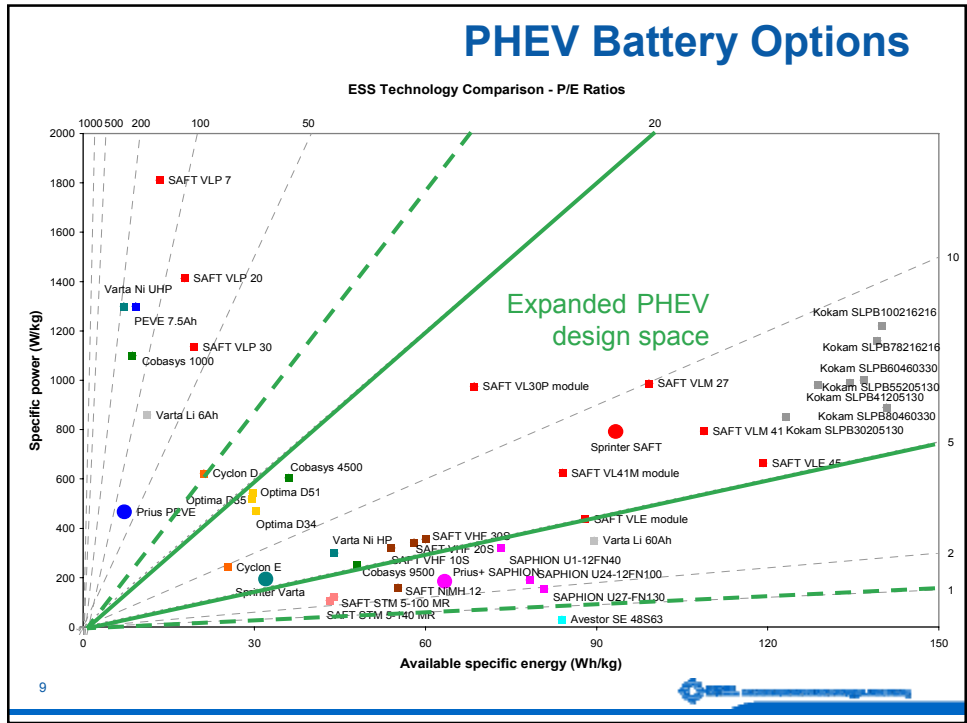

## Simulation of PHEV Efficiency and Cost

**Approach**

- Power-flow simulation in spreadsheet
- Mass-compounding produced via circular referencing
- Vehicle configurations:
  - conventional automatic
  - pre-transmission parallel hybrid: HEV or PHEV

- Calculates component sizes and costs including 74% retail markup
- Measures fuel/electricity consumption using NREL-proposed revisions to SAE J1711 (uses national average driving statistics)
- 2 powertrain technology scenarios – near term and long term
- **Battery definition is key input to the simulation**

## Powertrain Technology Scenarios

Battery	Near-Term Scenario	Long-Term Scenario
Chemistry	NiMH	Li-Ion
Module cost	Double EPRI projections, see slide 20	EPRI projections, see slide 20
Pack cost	$\$ = (\$/kWh + 13) \times kWh + 680$ (from EPRI study)	Same
Module mass	NiMH battery design function (Delucchi), see slide 19	Li-Ion battery design function (Delucchi), see slide 19
Pack mass	Tray + straps + thermal management = 0.06 kg/kg Harness + bus bars = 0.14 kg/kW (Delucchi)	Same
Efficiency	Equivalent circuit model based on P/E ratio	Same
SOC window	Based on JCI data for NiMH, see slide 21	Assumes Li-Ion achieves same cycle life as NiMH

Motor	Near-Term Scenario	Long-Term Scenario
Mass	DOE 2006 current status, see slide 15	Based on GM Precept motor drive, see slide 15
Efficiency	95% peak efficiency curve, see slide 14	Same
Cost	From EPRI study, see slide 16	From EPRI study, see slide 16

Engine	Near-Term Scenario	Long-Term Scenario
Mass	Based on MY2003 production engines, see slide 15	Same
Efficiency	35% peak efficiency curve, see slide 13	Same
Cost	From EPRI study, see slide 16	Same

11



## Baseline Vehicle Characteristics

MIDSIZE SEDAN (AUTOMATIC) – MSRP \$23,400	
<b>Platform Parameters</b>	
Glider Mass	905 kg
Curb Mass	1429 kg
Test Mass	1565 kg (136 kg load)
Gross Vehicle Mass (GVM)	1899 (470 kg load)
Drag coefficient	0.30
Frontal area	2.27m <sup>2</sup>
Rolling resistance coefficient	0.009
Accessory load	700 W elec. or 823 W mech.
<b>Performance Parameters</b>	
Standing acceleration	0-60 mph in 8.0 s
Passing acceleration	40-60 mph in 5.3 s
Top speed	110 mph
Gradeability	6.5% at 55 mph at GVM with 2/3 fuel converter power
<b>Vehicle attributes</b>	
Engine power	121 kW
Fuel economy	22.2 / 35.2 / 26.6 mpg (urban / highway / composite, unadjusted)



12



## Engine Map

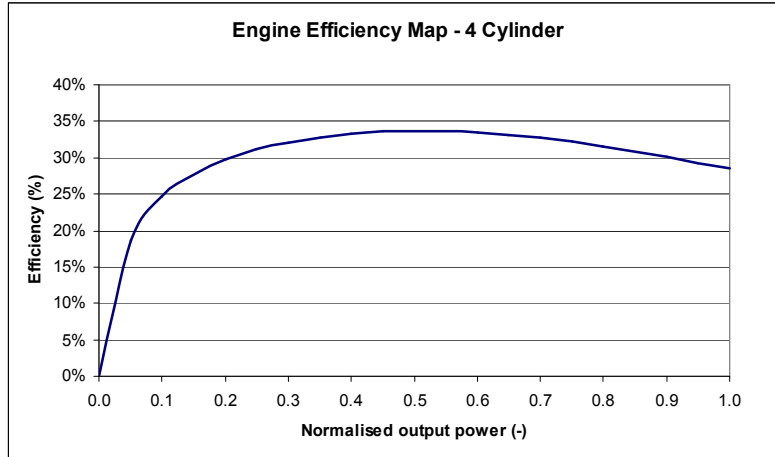

*Based on 1.9L, 95kW gasoline engine*

13



## Motor/Controller Map

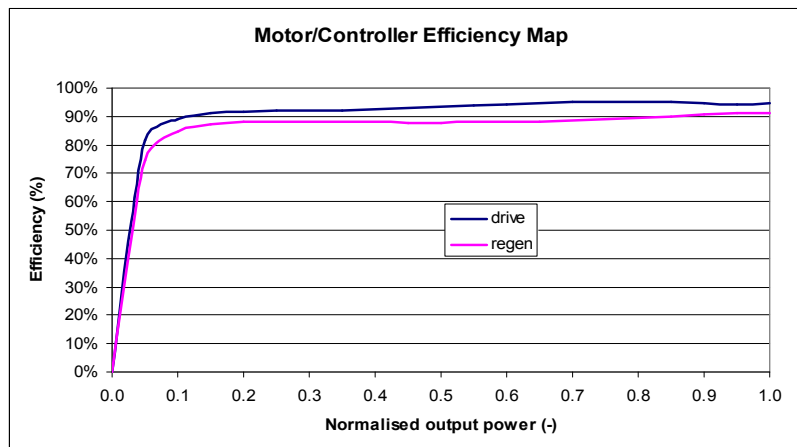

*Based on 50kW permanent magnet motor/controller*

14



## Engine / Motor Masses

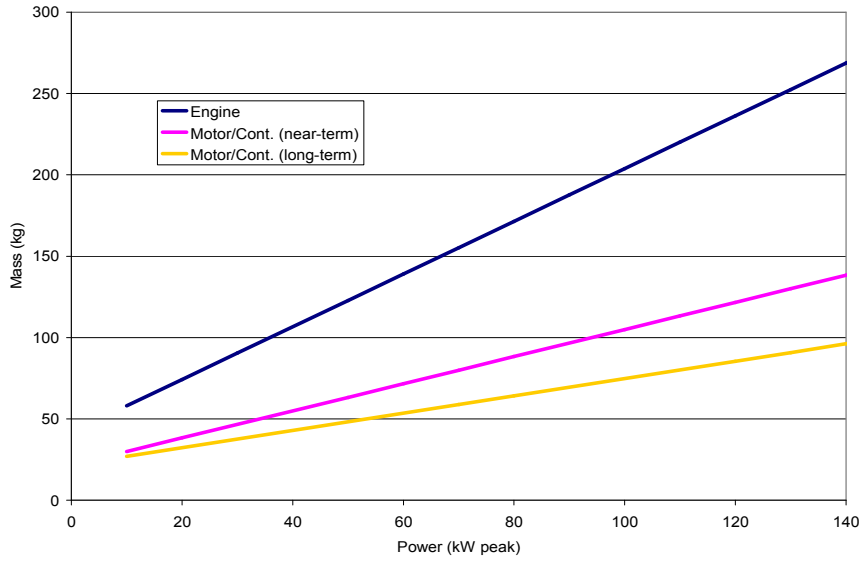

15



## Engine / Motor Costs

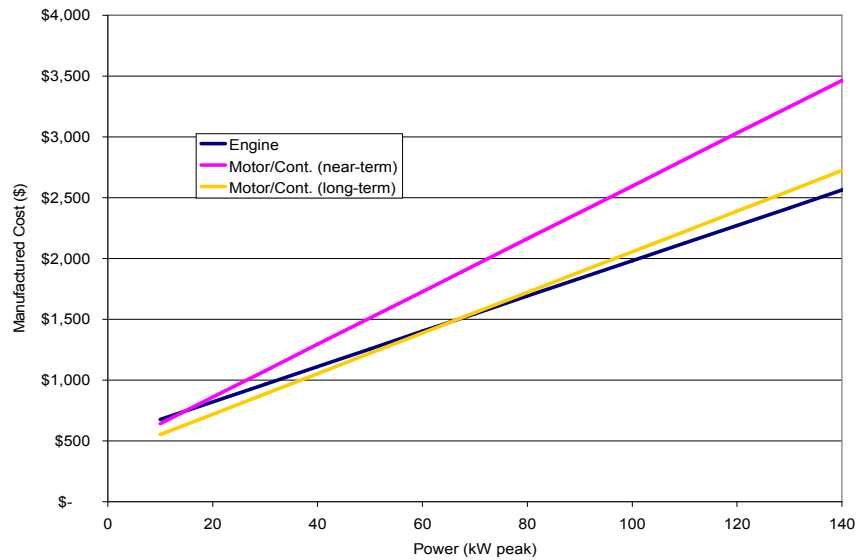

16



## Simulation Validation

### Conventional Automatic Midsize Sedan

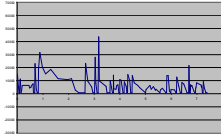

	Unadjusted Fuel Economy		
	Urban	Highway	Composite
Benchmark vehicle	22.2 mpg	35.2 mpg	26.6 mpg
Simulated vehicle	22.3 mpg	34.9 mpg	26.6 mpg

< 1% error

17



## Battery Definition as Key Input to Simulation

Input parameters that define the battery in BLUE

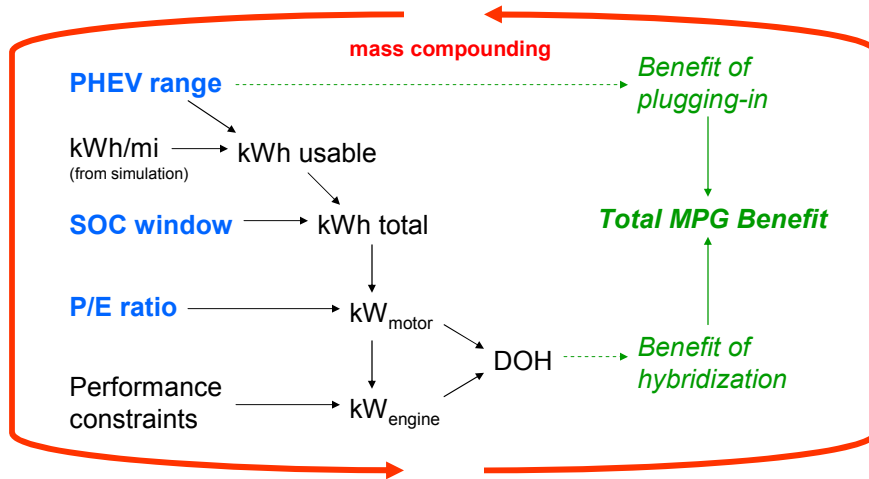

18

DOH = degree of hybridization





## Battery Model based on P/E Ratio

Battery Design Functions

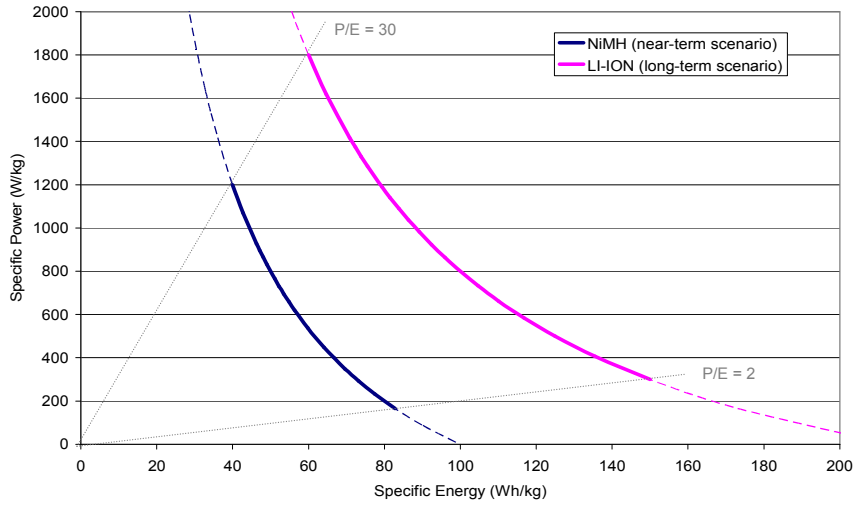

19



## Battery Model based on P/E Ratio

Battery Module Cost Functions

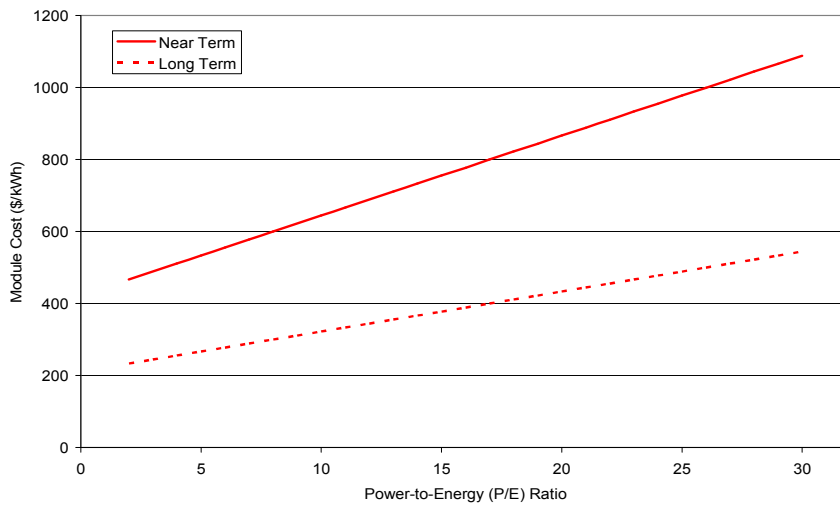

20



## Battery Model (cont.) – SOC Window

Battery SOC Operating Window vs. Specified All-Electric Range

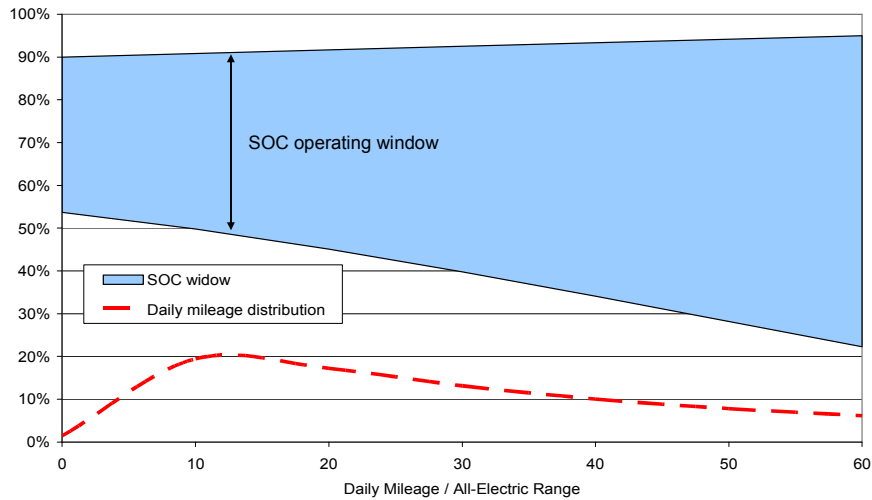

21

## HEV/PHEV Control Strategy

- Engine power request adjusted w.r.t. battery SOC

$$P_{\text{engine}} = P_{\text{driveline}} - k (\text{SOC} - \text{SOC}_{\text{target}})$$

- Engine turn-on/off strategy:

- engine turn-on occurs when

- » SOC-adjusted engine power request > 0

- idle-off allowed when

- » SOC-adjusted engine power request <= 0

- » **AND** vehicle is stationary

- » **AND** engine has been on for at least 5 minutes

- Motor provides supplemental power and does 60% of braking regeneratively (net recapture subject to component efficiencies)
- All component power limits are enforced
- Electric accessories

Idle-off for extended periods allows some PHEVs to avoid significant fuel-use penalty during charge-depleting mode.

To enable this, modifications to emissions control system would be required e.g. vacuum-insulated catalyst...

However, all vehicles (conventional and hybrid) can benefit from these systems

22

# Results



## PHEV Design Space

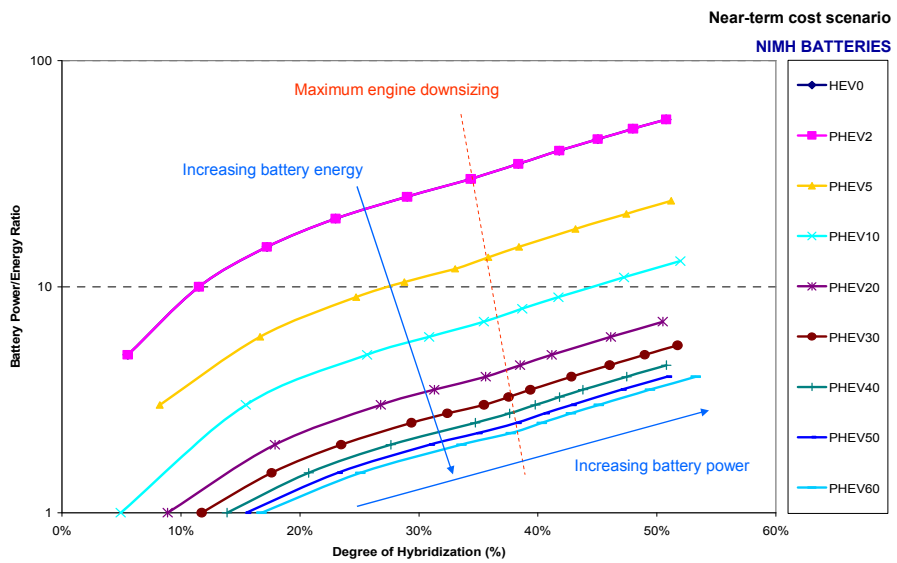

## Results – Fuel Consumption Reduction

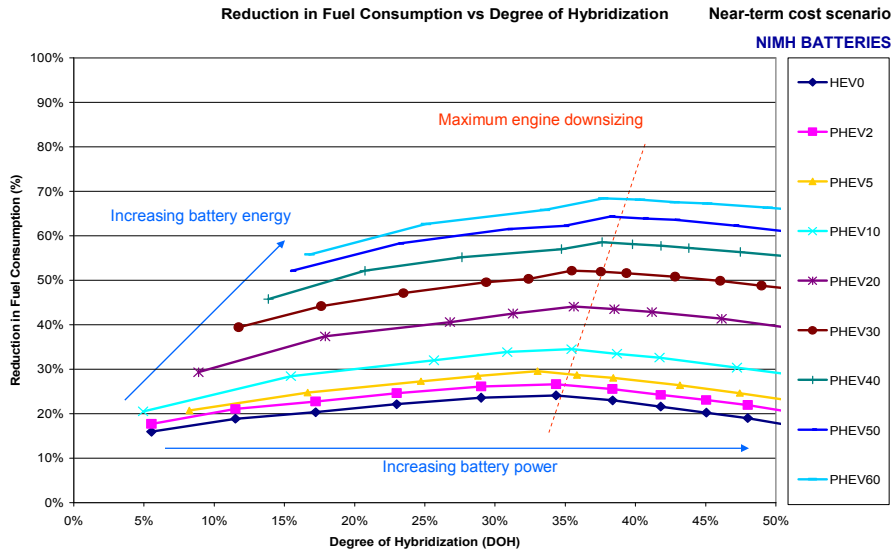

25



## Results – Powertrain Cost Increments

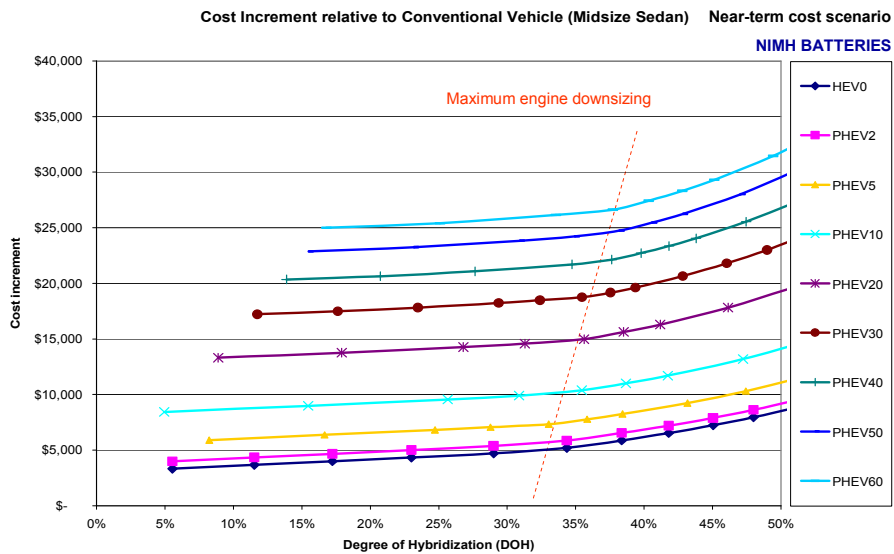

26



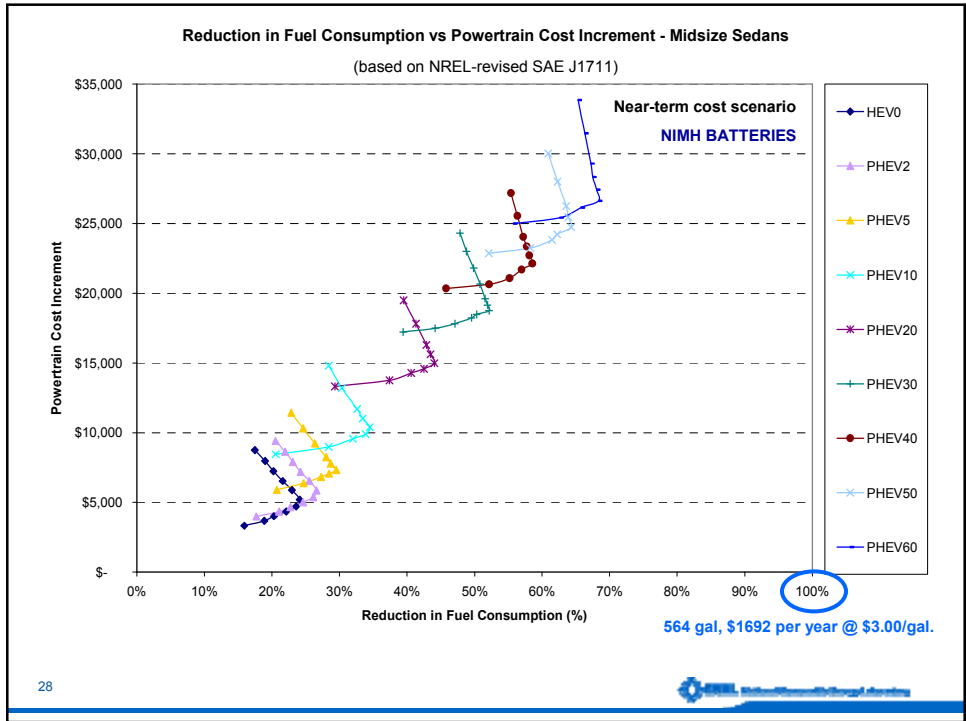
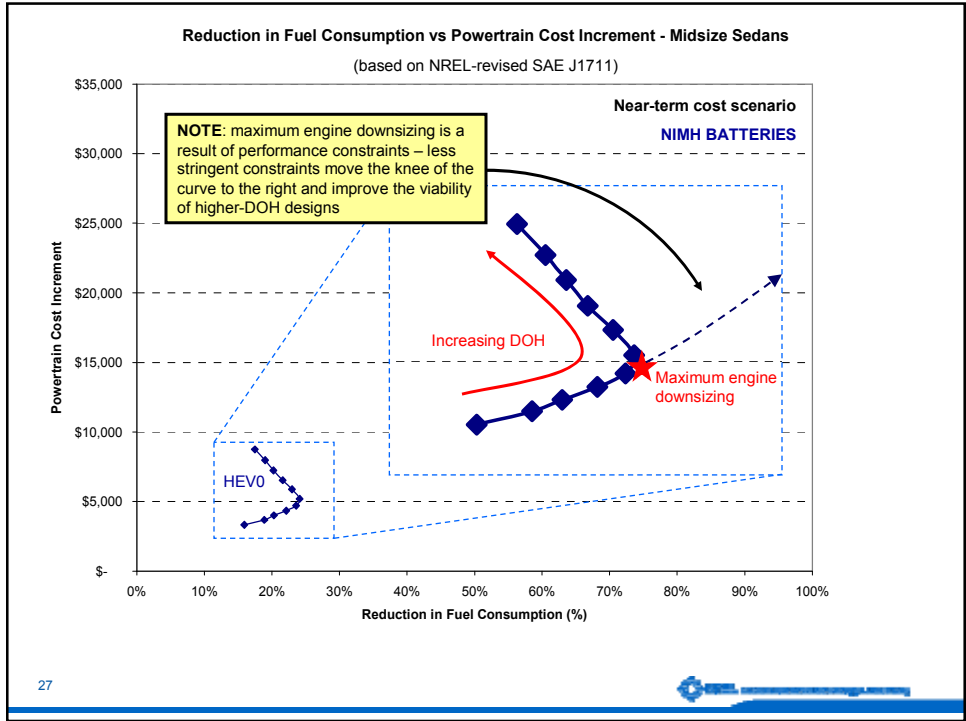

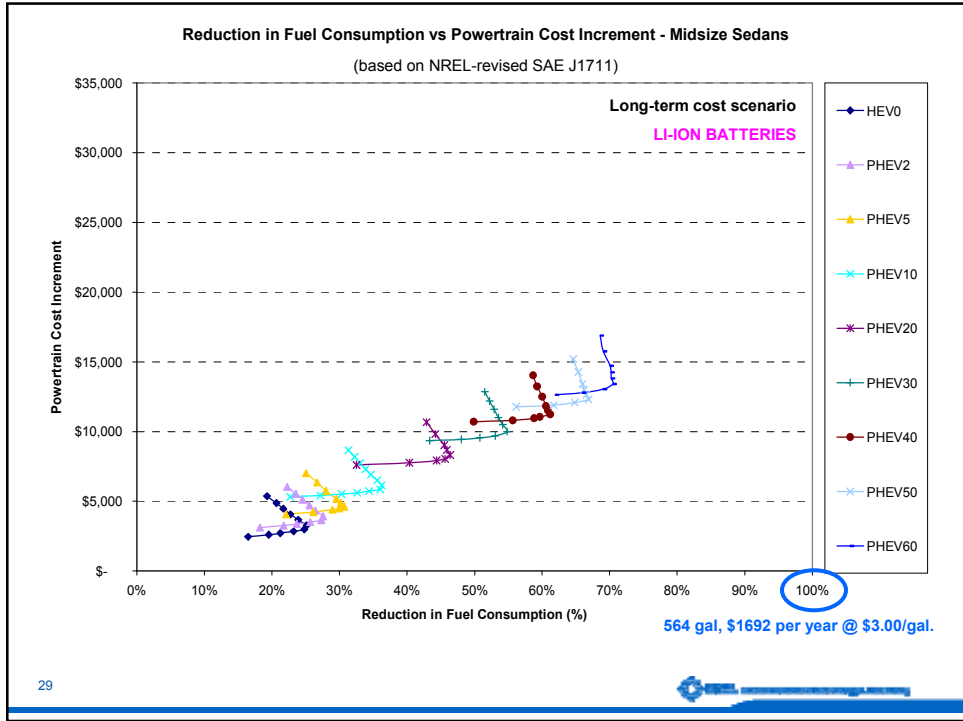

### Optimum PHEV Designs – Near & Long Term Scenarios

Near-term: NIMH BATTERIES										
Vehicle	Curb Mass (kg)	Engine (kW)	Motor (kW)	DOH	Battery (kWh)	P/E (1/h)	SOC	MPG	Wh/mi	Retail Cost Increment
CV	1429	121.7	---	---	---	---	---	26.6	0	\$ -
HEV0	1453	78.3	41.0	34%	1.5	30.0	37%	35.1	0	\$ 5,199
PHEV2	1453	78.3	41.0	34%	1.5	30.0	37%	36.3	11	\$ 5,863
PHEV5	1493	79.7	39.3	33%	3.5	12.0	39%	37.8	28	\$ 7,326
PHEV10	1566	81.9	45.0	35%	6.9	7.0	41%	40.6	54	\$ 10,389
PHEV20	1666	85.0	47.0	36%	12.6	4.0	47%	47.6	101	\$ 14,980
PHEV30	1747	88.2	48.5	35%	17.3	3.0	53%	55.6	138	\$ 18,754
PHEV40	1820	89.9	54.2	38%	21.1	2.8	59%	64.2	171	\$ 22,129
PHEV50	1875	91.6	56.6	38%	24.2	2.5	66%	74.6	197	\$ 24,737
PHEV60	1913	92.8	56.2	38%	26.6	2.3	73%	84.1	218	\$ 26,617

Long-term: LI-ION BATTERIES										
Vehicle	Curb Mass (kg)	Engine (kW)	Motor (kW)	DOH	Battery (kWh)	P/E (1/h)	SOC	MPG	Wh/mi	Retail Cost Increment
CV	1429	121.7	---	---	---	---	---	26.6	0	\$ -
HEV0	1416	77.2	40.4	34%	1.4	30.0	37%	35.5	0	\$ 3,261
PHEV2	1416	77.2	40.4	34%	1.4	30.0	37%	36.7	11	\$ 3,925
PHEV5	1438	77.8	38.4	33%	3.4	12.0	39%	38.4	27	\$ 4,623
PHEV10	1478	79.1	43.3	35%	6.6	7.0	41%	41.7	52	\$ 6,147
PHEV20	1528	80.7	44.5	36%	11.9	4.0	47%	49.6	95	\$ 8,314
PHEV30	1563	81.8	45.0	36%	16.1	3.0	53%	58.9	129	\$ 10,002
PHEV40	1588	82.6	44.8	35%	19.2	2.5	59%	68.6	157	\$ 11,236
PHEV50	1610	83.3	45.8	35%	21.8	2.3	66%	80.4	180	\$ 12,311
PHEV60	1637	84.1	50.4	37%	23.9	2.3	73%	90.2	198	\$ 13,406

30

# Annual Vehicle Mileage Schedule

used in following payback scenarios

Vehicle Mileage Schedule from NHTSA (2006)

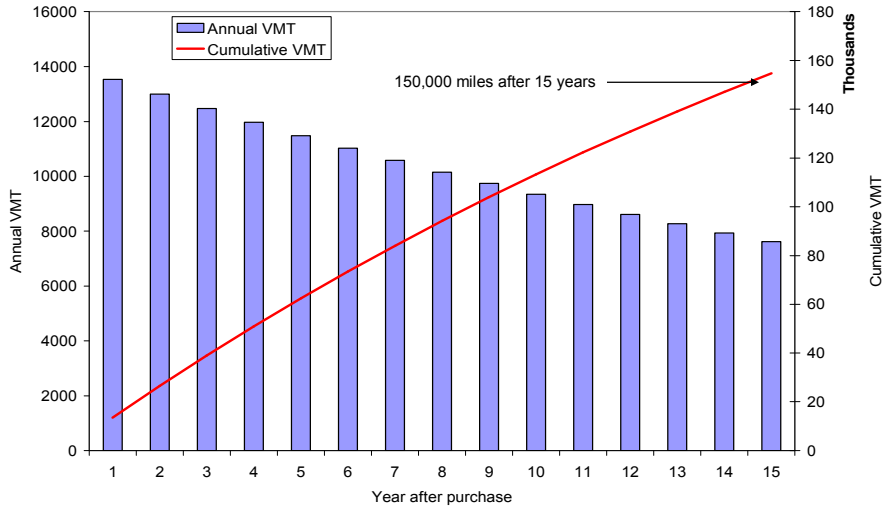

31



# Fuel Use Reduction from HEVs and PHEVs

Cumulative Per-Vehicle Fuel Use

Near-term cost scenario

NIMH BATTERIES

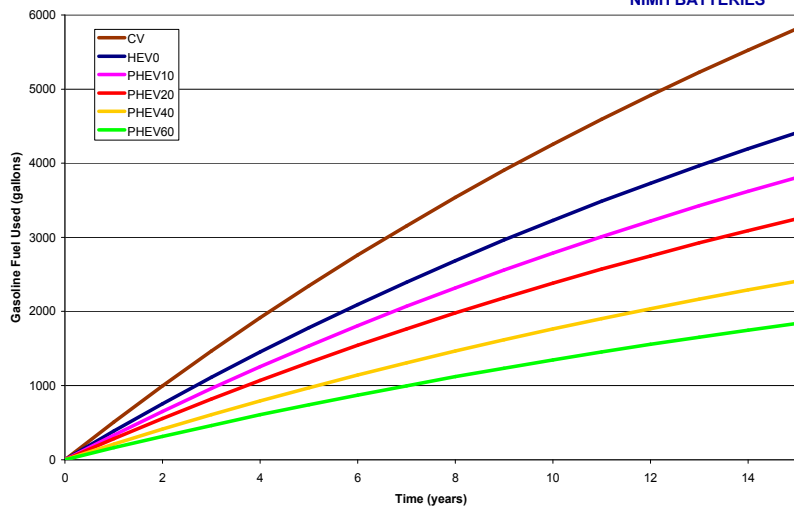

138 bbl



44 bbl

32



## Cost Reduction from HEVs and PHEVs

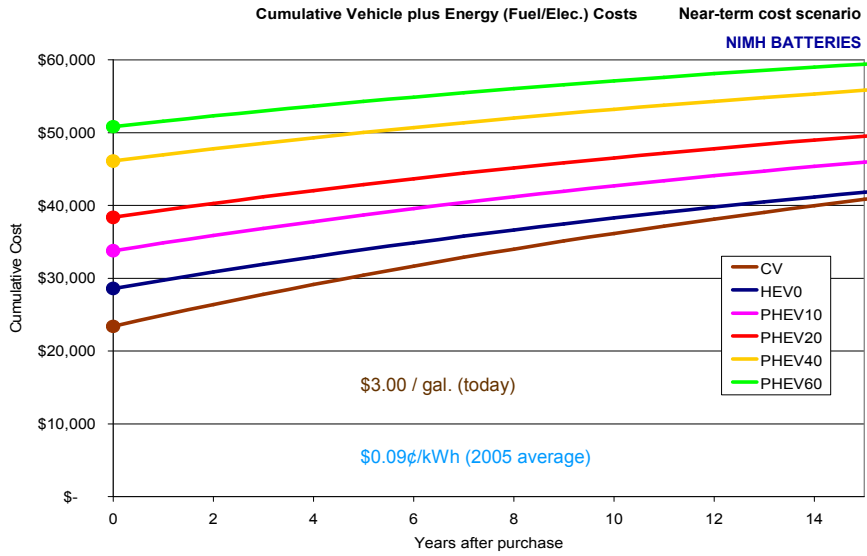

33

## Cost Reduction from HEVs and PHEVs (cont.)

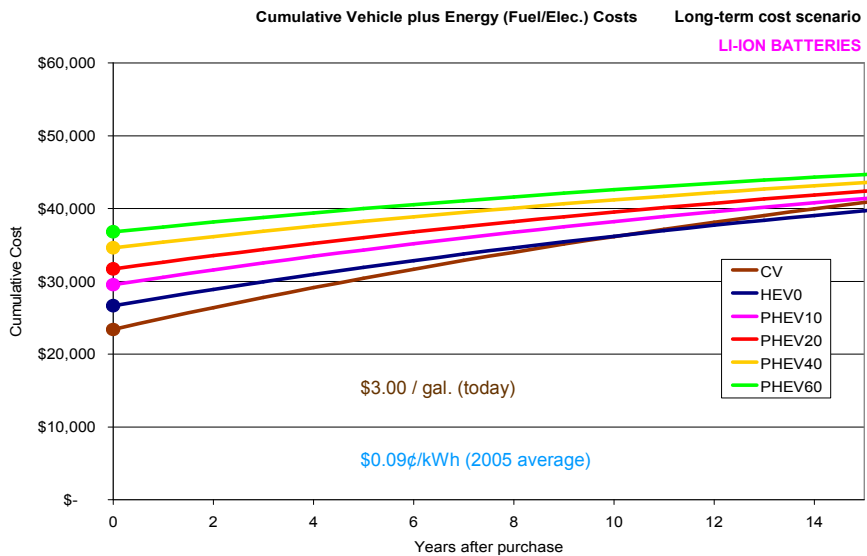

34



## Cost Reduction from HEVs and PHEVs (cont.)

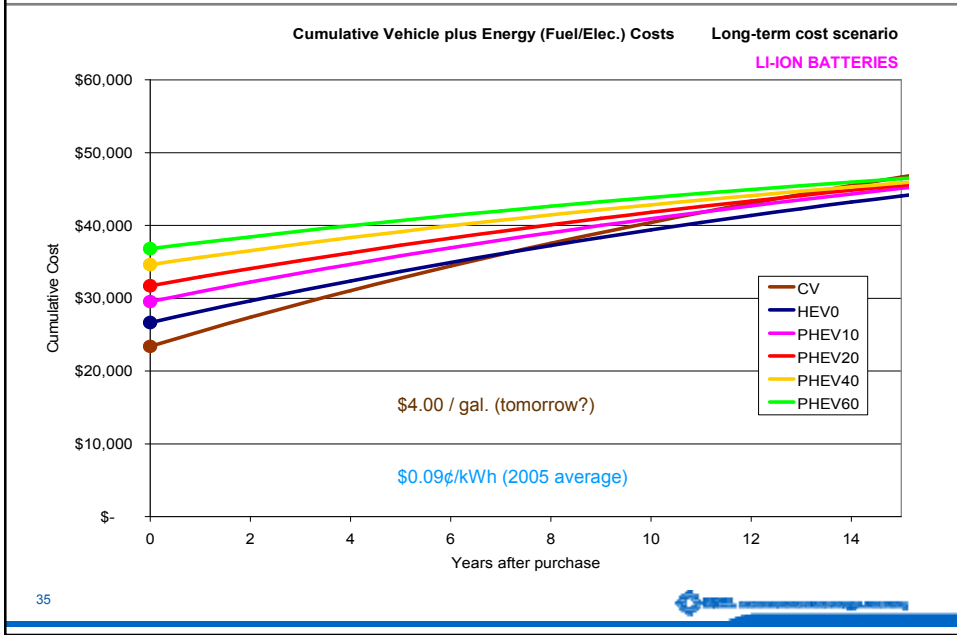

## Cost Reduction from HEVs and PHEVs (cont.)

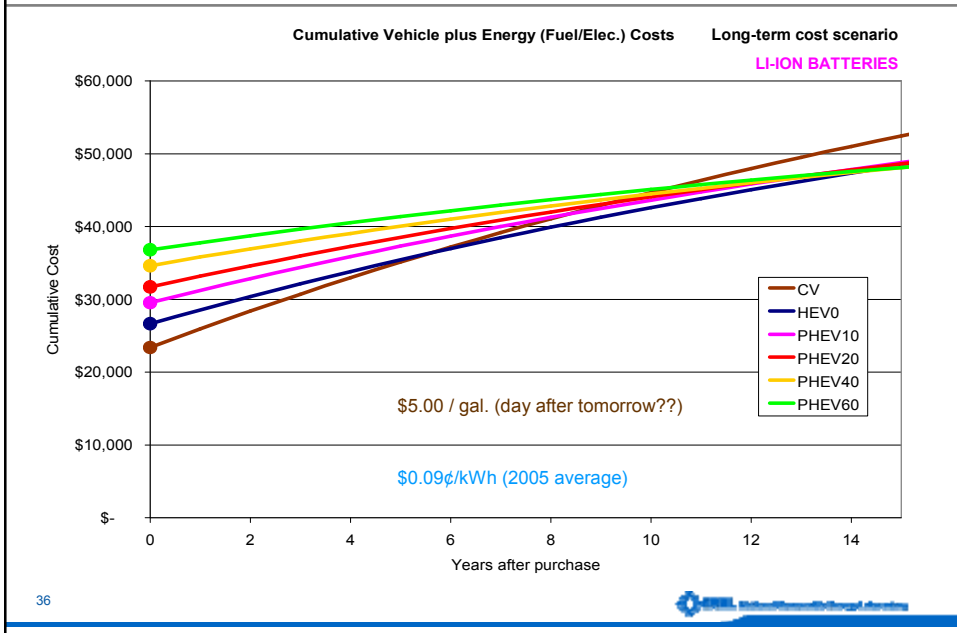

## HEV/PHEV Payback is Sensitive to Annual Mileage

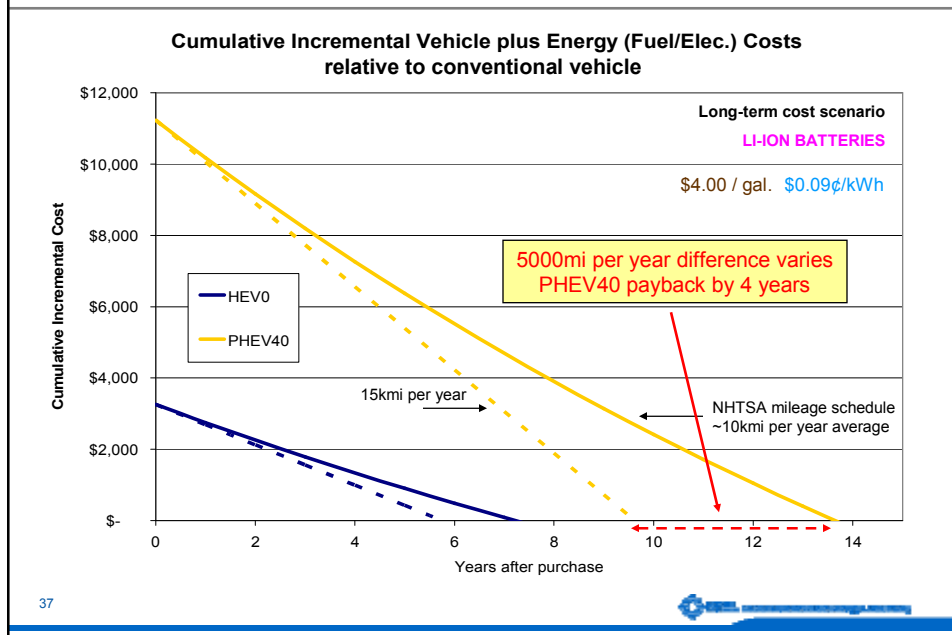

## Vehicle Costs cont.

### Why might PHEV buyers pay more?

1. Tax incentives
2. Reduced petroleum use, air pollution and CO<sub>2</sub>
3. National energy security
4. Less maintenance
5. Reduced fill-ups
6. Convenience of home recharging (off-peak)
7. Improved acceleration (high torque of electric motors)
8. Green image, "feel-good factor"
9. Vehicle-to-grid (V2G)

## Conclusions

1. There is a very broad spectrum of HEV-PHEV designs.
2. **Key factors** in the HEV/PHEV cost-benefit equation include:
  - **Battery costs**
  - **Fuel costs**
  - **Control strategy** (battery SOC window and emissions considerations)
  - **Driving habits** (annual VMT and trip-length distribution)
3. Based on the midsize vehicle platform, performance constraints, component technologies and control strategies used in this study:
  - HEVs can reduce per-vehicle fuel use by approx. 25%. Note this study did not consider benefits from platform engineering (i.e. mass/drag reduction).
  - PHEVs can **reduce per-vehicle fuel use by up to 45% for PHEV20s, up to 60% for PHEV40s and up to 70% for PHEV60s.**
  - In the long term, powertrain cost increments are predicted to be **\$2-5k for HEVs, \$7-11k for PHEV20s, \$10-14k for PHEV40s and \$13-17k for PHEV60s** assuming that projected component (battery) costs can be achieved.

39



## Conclusions (cont.)

4. Based on combined powertrain and energy costs:
  - At today's fuel and powertrain component costs, conventional vehicles are the most cost-competitive.
  - **HEVs become the most cost-competitive EITHER if fuel prices increase OR projected battery costs are achieved.**
  - **PHEVs become cost-competitive ONLY if projected battery costs are achieved AND fuel prices increase.**
  - Since high-range PHEVs reduce petroleum consumption the most, they might be good candidates for subsidies or tax-incentives to improve their cost-competitiveness and help realize national security goals.
  - Alternative business models (e.g. battery lease) could significantly improve the market for PHEVs

40



## Next Steps

- Expand the HEV-PHEV analysis space to include:
  - Platform engineering (mass/drag reduction)
  - Different performance constraints / component sizes
- Detailed simulation of promising PHEV designs:
  - Real world driving patterns (e.g. St Louis data)
  - Control strategy optimization
- Optimization of PHEV competitiveness using Technical Targets Tool
  - Various gas price and battery cost scenarios

## Section 2.2

**Title:** “Cost-Benefit Analysis of Plug-In Hybrid Electric Vehicle Technology”

**Type:** Paper

**Authors:** Andrew Simpson

**Date:** October 2006

**Conference or Meeting:** Published at the 22nd International Battery, Hybrid, and Fuel Cell Electric Vehicle Symposium and Exposition

**Abstract:** Explores the spectrum of PHEV design space with respect to battery options and quantifies the most cost-effective scenarios

# COST-BENEFIT ANALYSIS OF PLUG-IN HYBRID ELECTRIC VEHICLE TECHNOLOGY<sup>1</sup>

ANDREW SIMPSON  
National Renewable Energy Laboratory

## Abstract

Plug-in hybrid-electric vehicles (PHEVs) have emerged as a promising technology that uses electricity to displace petroleum consumption in the vehicle fleet. However, there is a very broad spectrum of PHEV designs with greatly-varying costs and benefits. In particular, battery costs, fuel costs, vehicle performance attributes and driving habits greatly-influence the relative value of PHEVs. This paper presents a comparison of the costs (vehicle purchase costs and energy costs) and benefits (reduced petroleum consumption) of PHEVs relative to hybrid-electric and conventional vehicles. A detailed simulation model is used to predict petroleum reductions and costs of PHEV designs compared to a baseline midsize sedan. Two powertrain technology scenarios are considered to explore the near-term and long-term prospects of PHEVs. The analysis finds that petroleum reductions exceeding 45% per-vehicle can be achieved by PHEVs equipped with 20 mi (32 km) or more of energy storage. However, the long-term incremental costs of these vehicles are projected to exceed US\$8,000, with near-term costs being significantly higher. A simple economic analysis is used to show that high petroleum prices and low battery costs are needed to make a compelling business case for PHEVs in the absence of other incentives. However, the large petroleum reduction potential of PHEVs provides strong justification for governmental support to accelerate the deployment of PHEV technology.

**Keywords:** Plug-in Hybrid; Hybrid-Electric Vehicles; Battery, Secondary Battery; Modeling, Simulation; Energy Security.

## 1 Introduction to Plug-In Hybrid-Electric Vehicles

Plug-in hybrid-electric vehicles have recently emerged as a promising alternative that uses electricity to displace a significant fraction of fleet petroleum consumption [1]. A plug-in hybrid-electric vehicle (PHEV) is a hybrid-electric vehicle (HEV) with the ability to recharge its electrochemical energy storage with electricity from an off-board source (such as the electric utility grid). The vehicle can then drive in a charge-depleting (CD) mode that reduces the system's state-of-charge (SOC), thereby using electricity to displace liquid fuel that would otherwise have been consumed. This liquid fuel is typically petroleum (gasoline or diesel), although PHEVs can also use alternatives such as biofuels or hydrogen. PHEV batteries typically have larger capacity than those in HEVs so as to increase the potential for petroleum displacement.

### 1.1 Plug-In Hybrid-Electric Vehicle Terminology

Plug-in hybrid-electric vehicles are characterized by a "PHEV<sub>x</sub>" notation, where "x" typically denotes the vehicle's all-electric range (AER) – defined as the distance in miles that a fully charged PHEV can drive before needing to operate its engine. The California Air Resources Board (CARB) uses the standard Urban Dynamometer Driving Schedule (UDDS) to measure the AER of PHEVs and provide a fair comparison between vehicles [2]. By this definition, a PHEV<sub>20</sub> can drive 20 mi (32 km) all-electrically on the test cycle before the first engine turn-on. However, this all-electric definition fails

---

<sup>1</sup> This work has been authored by an employee or employees of the Midwest Research Institute under Contract No. DE-AC36-99GO10337 with the U.S. Department of Energy. The United States Government retains and the publisher, by accepting the article for publication, acknowledges that the United States Government retains a non-exclusive, paid-up, irrevocable, worldwide license to publish or reproduce the published form of this work, or allow others to do so, for United States Government purposes.

to account for PHEVs that might continue to operate in CD-mode after the first engine turn-on. Therefore, the author uses a definition of PHEV<sub>x</sub> that is more appropriately related to petroleum displacement. By this definition, a PHEV20 contains enough useable energy storage in its battery to displace 20 mi (32 km) of petroleum consumption on the standard test cycle. Note that this definition does not imply all-electric capability since the vehicle operation will ultimately be determined by component power ratings and their control strategy, as well as the actual in-use driving cycle.

## 1.2 The Potential of Plug-In Hybrid-Electric Vehicles

The potential for PHEVs to displace fleet petroleum consumption derives from several factors. First, PHEVs are potentially well-matched to motorists' driving habits – in particular, the distribution of distances traveled each day. Based on prototypes from the last decade, PHEVs typically fall in the PHEV10-60 range [3]. Figure 1 shows the US vehicle daily mileage distribution based on data collected in the 1995 National Personal Transportation Survey (NPTS) [4]. Clearly, the majority of daily mileages are relatively short, with 50% of days being less than 30 mi (48 km). Figure 1 also shows the Utility Factor (UF) curve for the 1995 NPTS data. For a certain distance D, the Utility Factor is the fraction of total vehicle-miles-traveled (VMT) that occurs within the first D miles of daily travel. For a distance of 30 mi (48 km), the utility factor is approximately 40%. This means that an all-electric PHEV30 can displace petroleum consumption equivalent to 40% of VMT, (assuming the vehicle is fully recharged each day). Similarly, an all-electric PHEV60 can displace about 60%. This low-daily-mileage characteristic is why PHEVs have potential to displace a large fraction of *per-vehicle* petroleum consumption.

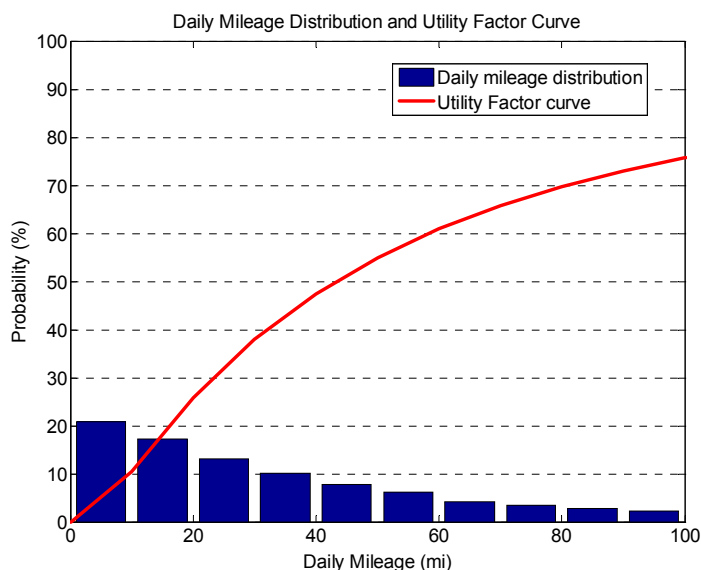

Figure 1: Daily mileage distribution for US motorists based on the 1995 National Personal Transportation Survey

However, for PHEVs to displace *fleet* petroleum consumption, they must penetrate the market and extrapolate these savings to the fleet level. A second factor that is encouraging for PHEVs is the success of HEVs in the market. Global hybrid vehicle production is currently several hundred thousand units per annum [5]. Because of this, electric machines and high-power storage batteries are rapidly approaching maturity with major improvements in performance and cost having been achieved. Although HEV components are not optimized for PHEV applications, they do provide a platform from which HEV component suppliers can develop a range of PHEV components.

Finally, PHEVs are very marketable in that they combine the beneficial attributes of HEVs and battery electric vehicles (BEVs) while mitigating their disadvantages. Production HEVs achieve high fuel economy, but they are still designed for petroleum fuels and do not enable fuel substitution/flexibility. PHEVs, however, are true fuel-flexible vehicles that can run on petroleum or electrical energy. BEVs do not require any petroleum, but are constrained by battery technologies resulting in limited driving ranges, significant battery costs and lengthy recharging times. PHEVs have a smaller battery which mitigates battery cost and recharging time while the onboard petroleum fuel tank provides driving range equivalent to conventional and hybrid vehicles. This combination of attributes is building a strong demand for PHEVs, as evidenced by the recently launched Plug-In Partners Campaign [6].

PHEVs have the potential to come to market, penetrate the fleet, and achieve meaningful petroleum displacement relatively quickly. Few competing technologies offer this potential combined rate and timing of reduction in fleet petroleum consumption [7]. However, PHEV technology is not without its challenges. Energy storage system cost, volume, and life are major obstacles that must be overcome for these vehicles to succeed. Increasing the battery storage beyond that of HEVs increases vehicle cost and presents significant packaging challenges. Furthermore, the combined deep/shallow cycling in PHEV batteries is uniquely more demanding than that experienced by HEVs or BEVs. PHEV batteries may need to be oversized to last the life of the vehicle, further increasing cost. Given that HEVs are succeeding in the market, the question relevant to PHEVs is, “What incremental petroleum reductions can be achieved at what incremental costs?” These factors will critically affect the marketability of PHEVs through their purchase price and cost-of-ownership. This paper presents the results of a study designed to evaluate this cost-benefit tradeoff.

## 2 Modeling PHEV Petroleum Consumption and Cost

The reduction of per-vehicle petroleum consumption in a PHEV results from two factors:

1. Petroleum displacement during CD-mode, which as previously discussed relates to the PHEV<sub>x</sub> designation based on the added battery energy capacity of the vehicle.
2. Fuel-efficiency improvement in charge-sustaining (CS) mode due to hybridization, which relates to the degree-of-hybridization (DOH) or added battery power capability of the vehicle. HEVs, which do not have a CD-mode, are only able to realize savings via this second factor.

For a PHEV<sub>x</sub>, these two factors can be combined mathematically as follows:

$$\frac{FC_{PHEV_x}}{FC_{CV}} = [1 - UF(x)] \frac{FC_{CS}}{FC_{CV}} \quad (1)$$

where  $FC_{PHEV_x}$  is the UF-weighted fuel consumption of the PHEV<sub>x</sub>,  $FC_{CV}$  is the fuel consumption of the reference conventional (non-hybrid) vehicle and  $FC_{CS}$  is the PHEV<sub>x</sub>'s CS-mode fuel consumption. Note that this expression becomes approximate for PHEVs without all-electric capability because use of the utility factor in this way assumes that no petroleum is consumed in the first  $x$  miles of travel.

Figure 2 uses Equation 1 to compare the petroleum reduction of various PHEV designs. We see there are a variety of ways to achieve a target level of petroleum reduction. For example, a 50% reduction is achieved by an HEV with 50% reduced fuel consumption, a PHEV20 with 30% CS-mode reduction and by a PHEV40 with 0% CS-mode reduction (this last example is unlikely since PHEVs will show CS-mode improvement due to hybridization, notwithstanding the increase in vehicle mass from the larger battery). To demonstrate the feasible range of CS-mode reduction, Figure 2 compares several contemporary HEVs to their conventional counterparts (in the case of the Toyota Prius, a comparison is made to the Toyota Corolla which has similar size and performance). At the low end of the spectrum, the “mild” HEV Saturn Vue achieves a modest reduction of less than 20%. The “full” HEV Toyota Prius achieves the highest percentage reduction (40%) of all HEVs currently on the market although, in addition to the platform enhancements employed in production hybrids, it also uses an

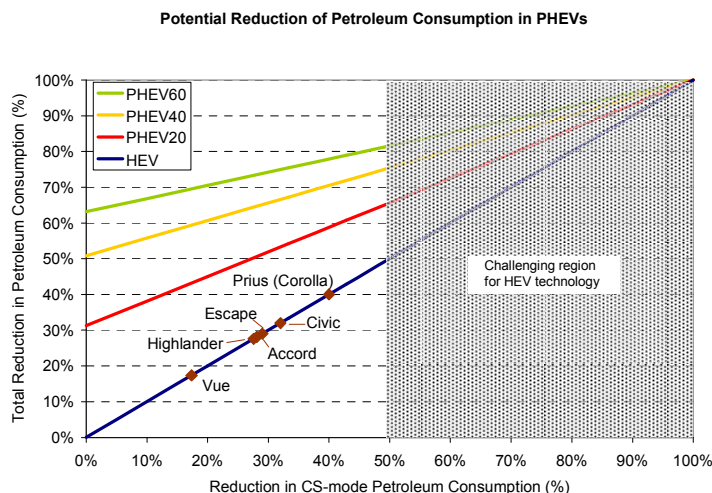

Figure 2: Potential per-vehicle reduction of petroleum consumption in PHEVs



advanced (Atkinson-cycle) engine technology. Note that none of the production HEVs achieve the 50% reduction discussed in the above example, suggesting that there is an upper limit on the benefit of hybridization alone. Reductions exceeding 50% are available through CD-mode operation in a PHEV, although increasing PHEV<sub>x</sub> ranges can be seen to provide diminishing returns due to the nature of the Utility Factor curve (Figure 1).

The PHEV design space in Figure 2 characterized by CS/CD-mode fuel consumption has a matching space characterized by battery power/energy. Improving CS-mode fuel consumption implies an increase in DOH and battery power, while increasing CD-mode benefit implies an increase in PHEV<sub>x</sub> and useable battery energy. Moving in either direction incurs additional vehicle costs. However, the link between battery specifications, CS/CD-mode reductions, and vehicle costs is not obvious and must be explored through detailed vehicle fuel consumption and cost modeling. Therefore, a model was developed to predict the petroleum reductions and costs of contrasting PHEV designs compared to a reference conventional vehicle. The details of this model are presented in the following sections.

## 2.1 Modeling Approach and Scope of the Study

The PHEV cost-benefit model includes several sub-models. First, a *performance model* calculates component sizes necessary to satisfy the performance constraints listed in Table 1. Second, a *mass balance* calculates the vehicle mass based on component sizes determined by the performance model. Third, an *energy-use model* simulates the vehicle's gasoline and electricity consumption over various driving cycles. The vehicle performance and energy-use models are coupled to vehicle mass, so the model is able to capture mass compounding in the sizing of components. Fourth, a *cost model* estimates the vehicle retail price based on the component sizes. All costs are reported in 2006 US dollars. Finally, the *results post-processing* performs calculations to report the vehicle energy consumption and operating costs in meaningful ways. The model is implemented in an iterative Microsoft Excel spreadsheet.

The energy-use model is a detailed, second-by-second, dynamic vehicle model that uses a reverse-calculation approach [8]. It is also characterized as a power-flow model since it models component losses/efficiencies as functions of device power, rather than as functions of torque/speed or current/voltage as in more detailed models. This reverse-calculation, power-flow method provides rapid estimation of vehicle energy usage and enables the coupled, iterative spreadsheet described above. A solution is obtained in only a few seconds, meaning that the design space can be explored very quickly and thoroughly. Several hundred PHEV designs were therefore included in the study.

The model performs simulations of both conventional vehicles (CVs) and HEVs (including PHEVs) so that side-by-side comparisons can be made. The performance and energy-use models were validated for a Toyota Camry sedan and Honda Civic Hybrid. In both cases, errors of less than 5% were observed in the estimates of vehicle performance and energy use.

Two powertrain technology scenarios (Table 2) were included in the study. The near-term scenario (2005-2010) represents vehicles produced using current-status powertrain technologies, whereas the long-term scenario (2015-2020) allows for advanced technologies expected to result from ongoing R&D efforts and high-volume production levels. The long-term scenario does not, however, include advanced engine technologies since the author wanted to isolate the impact of improved electric drive and energy storage technologies on the relative cost-benefit of PHEVs.

## 2.2 Vehicle Platform, Performance and Cost Assumptions

All vehicles included in the study satisfied the same performance constraints and used a vehicle platform identical to the baseline CV. The baseline CV was a midsize sedan (similar to a Toyota Camry or Chevrolet Malibu) and relevant parameters are presented in Table 1. Most parameters were calculated from sales-weighted average data for the top selling US midsize sedans in 2003 [9]. Some parameters, such as rolling resistance, accessory loads, passing acceleration, and gradeability, were engineering estimates. The baseline manufacturer's suggested retail price (MSRP) of US\$23,392 was

used in combination with the powertrain cost model to estimate the baseline “glider” cost (i.e. vehicle with no powertrain). The cost of a 121 kW CV powertrain was estimated at US\$6,002, leading to an estimated baseline glider cost of US\$17,390.

Table 1: Vehicle Platform and Performance Assumptions for Midsize Sedan

<b>Platform Parameters</b>		
Glider Mass	905 kg	
Curb Mass	1429 kg	
Test Mass	1565 kg (136 kg load)	
Gross Vehicle Mass (GVM)	1899 (470 kg load)	
Drag coefficient	0.3	
Frontal area	2.27m <sup>2</sup>	
Rolling resistance coefficient	0.009	
Baseline accessory load	800 W elec. (4000 W peak)	
<b>Performance Parameters</b>		
Standing acceleration	0-97 kph (0-60 mph) in 8.0 s	
Passing acceleration	64-97 kph (40-60 mph) in 5.3 s	
Top speed	177 kph (110 mph)	
Gradeability	6.5% at 88 kph (55 mph) at GVM with 2/3 fuel converter power	
<b>Vehicle attributes</b>		
Engine power	121 kW	
Fuel consumption	10.6 / 6.7 / 8.8 L per 100km (urban / highway / composite)	
MSRP	\$23,392	

Table 2: Powertrain Technology Scenarios for the Cost-Benefit Analysis

	Near-Term Scenario	Long-Term Scenario
<b>Battery</b>		
Chemistry	NiMH	Li-Ion
Module cost	Twice that of long-term scenario	\$/kWh = 11.1 x P/E + 211.1 [14]
Pack cost	\$ = (\$/kWh + 13) x kWh + 680 [14]	Same
Module mass	NiMH battery design function [15], see Figure 6	Li-Ion battery design function [15], see Figure 6
Pack mass	Tray/straps + thermal mgmt = 0.06 kg/kg [15] Harness + bus bars = 0.14 kg/kW [15]	Same
Efficiency	Equivalent circuit model based on P/E ratio, see Figure 5	Same
SOC window	SOC design window curve, see Figure 4	Same (assumes Li-Ion cycle life = NiMH)
<b>Motor</b>		
Mass	kg = 21.6 + 0.833 x kW [13]	kg = 21.6 + 0.532 x kW [14]
Cost	\$ = 21.7 x kW + 425 [14]	\$ = 16 x kW + 385 [14]
Efficiency	95% peak efficiency curve, see Figure 5	Same
<b>Engine</b>		
Mass	kg = 1.62 x kW + 41.8 [9]	Same
Cost	\$ = 14.5 x kW + 531 [14]	Same
Efficiency	34% peak efficiency curve, see Figure 5	Same

### 2.3 Powertrain Architecture

The two things that differentiate a PHEV from an HEV are the inclusion of a CD operating mode and a recharging plug. Therefore, a PHEV can be implemented using any of the typical HEV architectures (parallel, series, or power-split). For this study, a parallel architecture was assumed with the ability to declutch the engine from the powertrain (Figure 3). This parallel layout provides greater flexibility in engine on/off control compared to Honda’s integrated motor assist (IMA) parallel system [10]

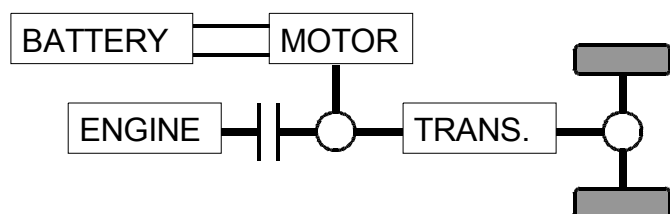

Figure 3: Parallel HEV powertrain architecture

where the engine and motor are always connected. To create more flexibility in engine on/off control, it was also assumed that all accessories (including air conditioning) would be powered electrically from the battery.

## 2.4 Component Sizing

### Battery

The battery is the first component sized by the model and the two key inputs are the PHEV<sub>x</sub> designation and the battery power-to-energy (P/E) ratio. The useable battery energy is calculated using an estimate of the vehicle's equivalent electrical energy consumption per unit distance multiplied by the target PHEV<sub>x</sub> distance. The electrical energy consumption is estimated using the PAMVEC model [11]. The total battery energy is then calculated based on the SOC design window. Finally, the rated battery power is calculated by multiplying the total battery energy by the input P/E ratio and then de-rating by 20% to account for battery power degradation at end-of-life.

To achieve similar battery cycle life, different PHEV<sub>x</sub> ranges require different SOC design windows. The daily mileage distribution (Figure 1) means that a PHEV10 is far more likely to experience a deep cycle than a PHEV60. Therefore, the SOC design window must be chosen such that the average daily SOC swing is consistent across the range of PHEVs. Figure 4 shows the SOC design windows assumed in the PHEV cost-benefit model, based on cycle-life data presented by Rosenkrantz [12] and a target battery life of 15 years (assuming one full recharge each day). Figure 4 also shows the resulting average daily SOC swing which is consistent across the range.

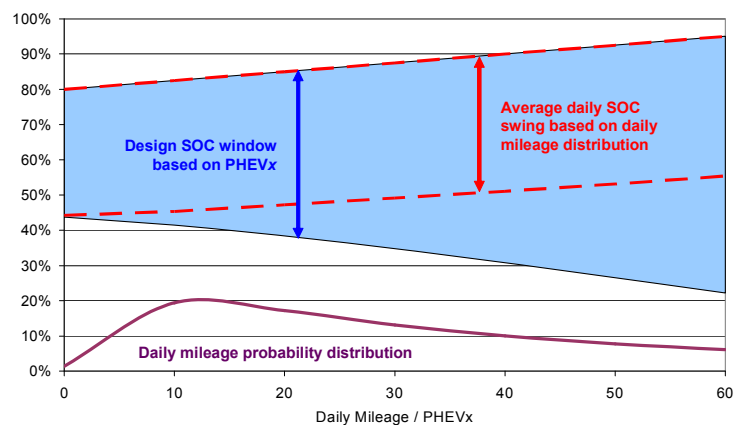

Figure 4: SOC design window for PHEVs

### Electric Motor

The motor power is matched to the battery power, but with the resulting motor power being slightly smaller after accounting for electric accessory loads and motor/controller efficiency.

### Engine

Several steps are required to size the engine. First, the required peak power of the engine plus motor is calculated using the PAMVEC model [11]. This power is typically dictated by the standing acceleration performance and for the baseline midsize platform is approximately 120kW. The motor power is then subtracted from the total to provide a requirement for the engine power. This produces some “engine downsizing,” but there are downsizing limits imposed by other performance constraints. Continuous performance events (gradeability and top speed) determine the minimum permissible engine size. Gradeability performance is limited to 2/3 of peak engine power due to engine thermal management and noise, vibration, and harshness (NVH) considerations. For the baseline midsize platform, the minimum engine size is approximately 80kW.

## 2.5 Component Efficiencies, Masses, and Costs

### Engine and Electric Motor

As discussed in section 2.1, the PHEV energy-use model is a reverse-calculation, power-flow model that simulates component losses/efficiencies as a function of output power. Both the engine and electric motor efficiencies are modeled using polynomial expressions for component input power as a function of output power. The engine curve is based on a 4-cylinder, 1.9L, 95kW gasoline engine. A 3<sup>rd</sup>-order polynomial was fitted to data from an ADVISOR simulation [8] using this engine. The

motor curve is based on a 50kW permanent magnet machine and a 9<sup>th</sup>-order polynomial was fitted to data from an ADVISOR simulation using this motor. Both efficiency curves are shown in Figure 5.

The engine and motor masses and costs are modeled as linear functions of rated output power. The engine mass function is derived from a database of 2003 model-year vehicles [9]. The near-term motor-controller mass function is based on the 2006 current status listed in the FreedomCAR and Vehicle Technologies Program Plan [13]. The long-term motor-controller mass is based on technology demonstrated in the GM Precept concept vehicle [14]. The engine cost function is based on manufacturers' data provided to the EPRI Hybrid-Electric Vehicle Working Group (HEVWG) [14]. The near-term and long-term motor cost functions are also based on data reported by EPRI [14].

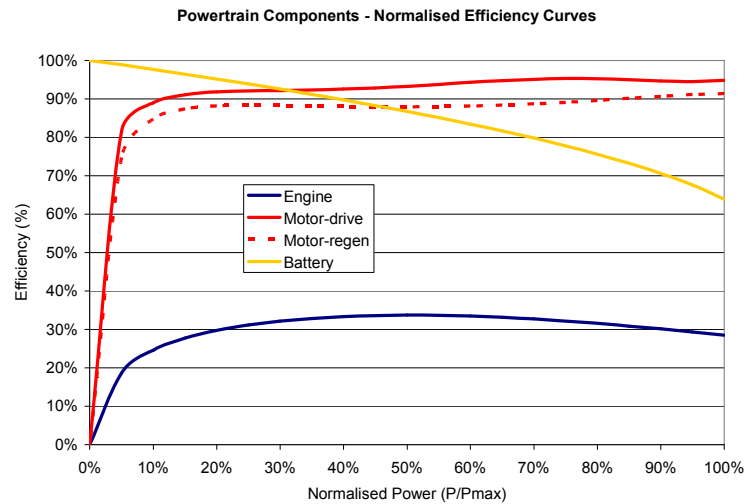

Figure 5: Efficiency curves used in the PHEV cost-benefit model

### Battery

Battery efficiency is modeled using a normalized function for efficiency vs. input power (Figure 5). This relationship was derived from an equivalent circuit model using realistic values for nominal open-circuit voltage and internal impedance. Battery-module mass for both NiMH and Li-Ion technology is modeled using battery design functions developed by Delucchi [15] and shown in Figure 6. The added mass of battery packaging and thermal management was also based on [15].

Battery-module-specific costs (\$/kWh) vary as a function of power-to-energy ratio (Figure 6). The long-term Li-Ion cost curve is based on estimates from EPRI [14]. After speaking with battery suppliers and other experts, it was estimated that the near-term specific cost of NiMH modules was approximately double that of EPRI's long-term prediction. The costs of battery packaging and thermal management are also based on those listed in [14].

### Recharging Plug and Charger

PHEVs are assumed to be equipped with an inverter-integrated plug/charger with 90% efficiency and an incremental manufactured cost of US\$380 over the baseline inverter cost [14].

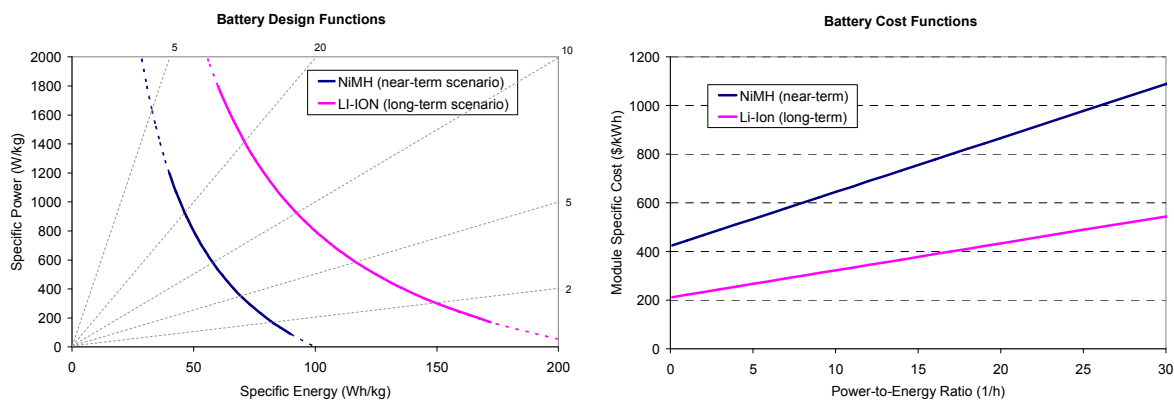

Figure 6: Battery design functions and module cost curves assumed for NiMH and Li-Ion technology

### *Retail Markup Factors*

The component cost functions in Table 2 model the manufactured cost of components. To convert these to retail costs in a vehicle, various markup factors are applied. A manufacturer's markup of 50% and dealer's markup of 16.3% are assumed based on estimates by EPRI [14]

## **2.6 Powertrain Control Strategy**

A generic control strategy was developed for the spectrum of PHEV designs. This control strategy consists of four basic elements. The basis of the strategy is an SOC-adjusted engine power request:

$$P_{engine-request} = P_{driveline} - k(SOC - SOC_{target}) \quad (2)$$

When the SOC is higher than the target, the engine power request is reduced to promote CD operation. Alternatively, when the SOC is lower than the target, the engine power request is increased to recharge the battery. The adjustment is governed by the factor  $k$  which is set proportional to total battery capacity. An electric-launch speed of 10 mph (16 kph) is also specified, below which the strategy tries to operate the vehicle all-electrically by setting the engine power request to zero. However, both the SOC adjustment and electric launch can cause the power ratings of the motor to be exceeded. Therefore, a third element of the strategy is to constrain the engine power request to within acceptable limits such that no components are overloaded. Finally, there is engine on/off control logic. The engine is triggered on whenever the adjusted engine power request becomes positive. Once on, however, the engine can only turn off after it has been on for at least 5 minutes. This final constraint is designed to ensure the engine warms up thoroughly so that repeated cold starts are avoided.

The aim of this control strategy is to prioritize discharging of the battery pack. Given the nature of the daily mileage distribution, this approach ensures that the maximum petroleum will be displaced. However, the strategy does not explicitly command all-electric operation. Rather, it discharges battery energy at the limits of the battery/motor power capabilities and uses the engine as needed to supplement the road load power demand. Therefore, the vehicle behavior that results is totally dependent on the power ratings of components. Vehicles with higher electric power ratings will have all-electric capability in more aggressive driving, whereas vehicles with lower electric power ratings will tend to operate in a "blended" CD-mode that utilizes both motor and engine. For more discussion of all-electric vs "blended" operation, the reader is directed to [16].

## **2.7 Driving Cycles**

The cost-benefit model simulates CVs, HEVs, and PHEVs over two cycles – the Urban Dynamometer Driving Schedule (UDDS) and the Highway Fuel Economy Test (HWFET) – used by the US Environmental Protection Agency (EPA) for fuel economy and emissions testing and labeling [17].

## **2.8 Fuel Economy Measurement and Reporting**

The PHEV fuel economies and operating costs are measured and reported using a procedure based on a modification of the Society of Automotive Engineers' (SAE) *J1711 Recommended Practice for Measuring the Exhaust Emissions and Fuel Economy of Hybrid-Electric Vehicles* [18]. This procedure measures the fuel and electricity use in both CD and CS-modes and weights them according to the Utility Factor (UF), assuming the PHEVs are fully-recharged each day. Further discussion of this procedure for fuel economy measurement and reporting is provided in [17].

## **3 Results**

PHEV2, 5, 10, 20, 30, 40, 50, and 60 vehicles were considered in the study. Also, an HEV0 was modeled as a PHEV2 with its charger/plug removed. P/E ratios were chosen to vary DOH (defined as the ratio of motor power to total motor plus engine power) across a range of approximately 10%–55%. Note that the engine downsizing limit corresponds to a DOH of approximately 32%, and that DOH higher than this results in excess electric power capability onboard the vehicle.

Figure 7 shows the battery specifications for the spectrum of PHEVs in the long-term scenario. The total battery energy varies from approximately 1.5 kWh for the HEV0/PHEV2 to approximately 25kWh for the PHEV60. The battery power varies from approximately 10–100kW across the range of DOH. Figure 7 includes dashed lines of constant P/E ratio, which varied from approximately 1–50. Figure 7 also indicates the minimum battery power requirement (approximately 45kW) for the PHEVs to have all-electric capability on the UDDS test cycle. The battery specifications for the near-term scenario are similar to Figure 7 but have increased power and energy requirements due to mass-compounding from the lower specific energy of NiMH batteries.

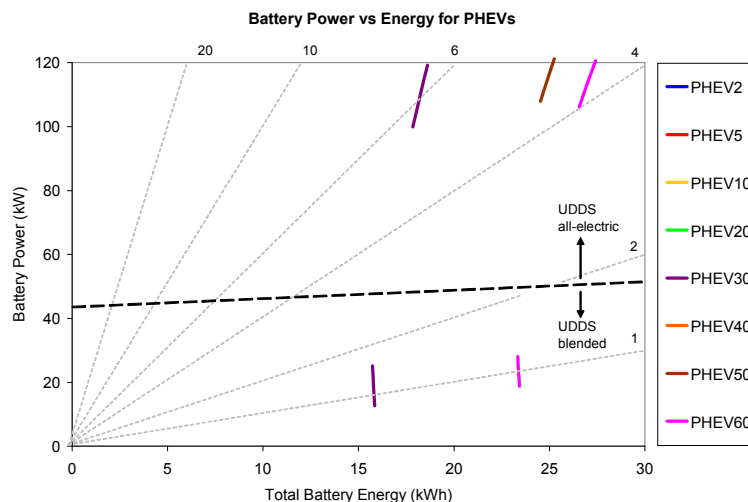

Figure 7: Battery specifications for the spectrum of PHEV designs (long-term scenario)

Figure 8 presents the reductions in annual petroleum consumption and incremental costs for the spectrum of PHEVs in the long-term scenario. Taking a macroscopic view, we see that increasing PHEV<sub>x</sub> provides increasing reduction in petroleum consumption. Relative to the baseline CV, which consumes 659 gal (2494 L) of petroleum based on 15,000 mi (24,100 km) each year, the HEVs reduce petroleum consumption by 20%–28%. The PHEVs reduce petroleum consumption further, ranging from 21%–31% for the PHEV2s up to 53%–64% for the PHEV60s. However, these increasing reductions come at increasing costs.

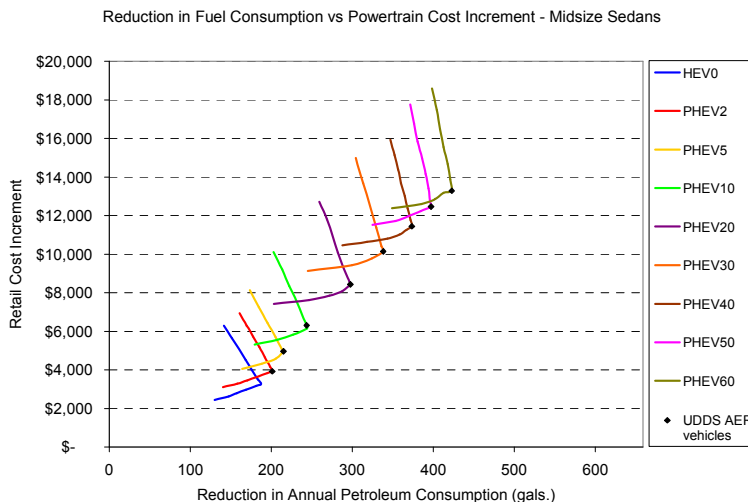

Figure 8: Incremental costs and annual petroleum consumption for the spectrum of PHEV designs (long-term scenario)

The HEV0s are projected to cost US\$2,000–\$6,000 more than the baseline CV, whereas the PHEV60s are projected to cost US\$12,000–\$18,000 more. The near-term trend is quite similar to Figure 8, except that petroleum reductions are slightly reduced and vehicle cost increments are much larger due to the greater mass and significantly higher cost of near-term NiMH batteries.

Looking closely at Figure 8, we see a repeated trend in the relative cost-benefit of PHEVs with varying DOH, and there is an optimum DOH for each PHEV<sub>x</sub>. For the HEV0s, the optimum DOH (32%) coincides with the limit of engine downsizing. For the PHEVs, the optimum DOH is higher (35%) to coincide with the minimum battery power required for all-electric capability on the UDDS cycle (the maximum power requirement on the HWFET cycle is lower). This all-electric capability allows vehicles to avoid engine idling losses that would otherwise be incurred due to engine turn-on events subject to the 5-minute minimum engine on time constraint. The optimum HEVs and PHEVs for the near-term and long-term scenarios are summarized in Tables 3 and 4.

It must be emphasized that these optimum DOH are highly-dependent on the vehicle platform/performance attributes and the nature of the driving pattern. The analysis should be repeated for other baseline vehicles (e.g. sport-utility vehicles) to see how the PHEV designs will vary. Furthermore, PHEVs should be simulated over real-world driving cycles to identify differences in the petroleum displacement and all-electric operation compared to standard test cycles. Such further analyses should provide the understanding needed to optimize PHEVs for the market.

Table 3: Near-Term Scenario PHEV Specifications – Optimum DOH Vehicles

Vehicle	Curb Mass (kg)	Engine Power (kW)	Motor Power (kW)	DOH	Battery Energy (kWh)	P/E Ratio (1/h)	SOC Window	Fuel Cons. (L/100km)	Elec. Cons. (Wh/km)	Retail Cost (US\$)
CV	1429	122	---	---	---	---	---	10.3	---	23,392
HEV0	1451	78	38	33%	1.5	33.4	37%	7.5	---	28,773
PHEV2	1451	78	38	33%	1.5	33.4	37%	7.3	7	29,435
PHEV5	1505	80	42	35%	3.6	15.9	39%	7.1	17	31,447
PHEV10	1571	82	44	35%	6.9	8.6	41%	6.7	33	34,180
PHEV20	1678	85	47	35%	12.7	4.9	47%	6.0	60	38,935
PHEV30	1759	89	49	36%	17.2	3.8	53%	5.4	84	42,618
PHEV40	1824	91	51	36%	20.8	3.3	59%	4.8	104	45,655
PHEV50	1880	94	52	36%	23.9	2.9	66%	4.5	118	48,162
PHEV60	1923	96	53	36%	26.4	2.7	73%	4.1	133	50,184

Table 4: Long-Term Scenario PHEV Specifications – Optimum DOH Vehicles

Vehicle	Curb Mass (kg)	Engine Power (kW)	Motor Power (kW)	DOH	Battery Energy (kWh)	P/E Ratio (1/h)	SOC Window	Fuel Cons. (L/100km)	Elec. Cons. (Wh/km)	Retail Cost (US\$)
CV	1429	122	---	---	---	---	---	10.3	---	23,392
HEV0	1412	77	36	32%	1.5	32.8	37%	7.4	---	26,658
PHEV2	1412	77	36	32%	1.5	32.8	37%	7.2	7	27,322
PHEV5	1445	78	41	34%	3.5	15.7	39%	7.0	17	28,365
PHEV10	1481	79	42	35%	6.6	8.5	41%	6.5	32	29,697
PHEV20	1531	81	43	35%	11.8	4.9	47%	5.7	58	31,828
PHEV30	1569	82	44	35%	15.9	3.7	53%	5.0	78	33,533
PHEV40	1598	83	45	35%	19.0	3.2	59%	4.5	96	34,839
PHEV50	1618	84	45	35%	21.6	2.8	66%	4.1	108	35,857
PHEV60	1636	84	46	35%	23.6	2.6	73%	3.7	120	36,681

### 3.1 Economics of PHEVs

The PHEV cost-benefit analysis also includes a simple comparison of cost-of-ownership over the vehicle lifetime. The comparison includes the retail cost of the vehicle and the cost of its annual energy (fuel and electricity) consumption, but does not account for possible differences in maintenance costs (for a more thorough analysis of total PHEV lifecycle costs, the reader is directed to [14]). Figure 9 presents economic comparisons for the near-term and long-term scenarios. In calculating annual petroleum and electricity consumption, all vehicles are assumed to travel 15,000 mi (24,100 km) per year to be consistent with the assumptions of the US EPA. The near-term cost of retail gasoline is assumed to be US\$3 per gallon (US\$0.79 per L), whereas a higher gasoline cost of US\$5 per gallon (US\$1.32 per L) is assumed for the projected scenario. The cost of retail electricity is held constant at US\$0.09 per kWh based on the 2005 US average retail price and historical trends [19]. No discount rate was applied to future cash flows.

In the near-term scenario, the HEV achieves a lower cost-of-ownership than the CV after approximately 10 years. However, the PHEVs never achieve a lower cost-of-ownership than the CV nor the HEV over the 15-year vehicle lifetime. The long-term scenario provides a significant contrast, with the HEV providing lower cost than the CV after approximately 4 years and the PHEVs providing lower cost than the HEV after approximately 12 years.

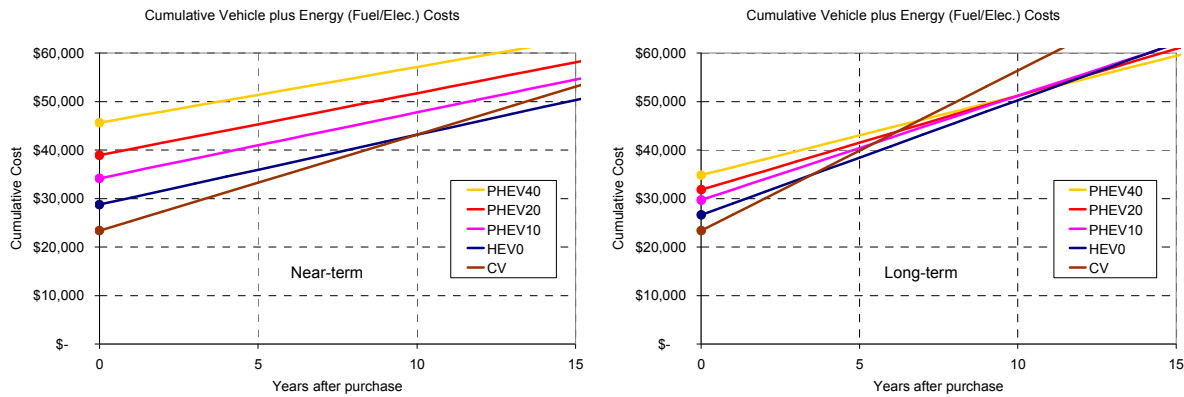

Figure 9: Economic comparison of PHEVs in the near-term and long-term scenarios

Several observations can be made from these comparisons. It is clear that these “payback” analyses are sensitive to the cost of gasoline and also the vehicle retail costs, which are strongly affected by the battery cost assumptions in each scenario. It is also clear that the economics of PHEVs are not promising if gasoline prices remain at current levels and battery costs cannot be improved. However, it does seem that a compelling business case for plug-in hybrids can be made under a scenario of both higher gasoline prices and projected (lower) battery costs, at least from the perspective of the simple consumer economic comparison presented here.

Despite the uncertainty of PHEV economics, there are other factors that may justify the incremental PHEV cost. Examples include tax incentives; reductions in petroleum use, air pollution, and greenhouse emissions; national energy security; reduced maintenance; fewer fill-ups at the gas station; convenience of home recharging; improved acceleration from high-torque electric motors; a green image; opportunities to provide emergency backup power in the home; and the potential for vehicle-to-grid applications. Alternative business models—such as battery leasing—also deserve further consideration since they might help to mitigate the daunting incremental vehicle cost and encourage PHEV buyers to focus on the potential for long-term cost savings.

## 4 Conclusion

This paper has presented a comparison of the costs (vehicle purchase costs and energy costs) and benefits (reduced petroleum consumption) of PHEVs relative to HEVs and CVs. Based on the study results, there is a very broad spectrum of HEV-PHEV designs with greatly varying costs and benefits. Furthermore, the PHEV cost-benefit equation is quite sensitive to a range of factors. In particular, battery costs, fuel costs, vehicle performance, and driving habits have a strong influence on the relative value of PHEVs. Given the large variability and uncertainty in these factors, it is difficult to predict the future potential for PHEVs to penetrate the market and reduce fleet petroleum consumption.

However, the potential for PHEVs to reduce *per-vehicle* petroleum consumption is clearly very high. Reductions in excess of 45% are available using designs of PHEV20 or higher. This compares favorably with the 30% maximum reduction estimated for HEVs. However, it seems likely that the added battery capacity of a PHEV will result in significant vehicle cost increments, even in the long term. For the projected scenario in this study, a retail cost increment of US\$3,000 was estimated for a midsize sedan HEV. In contrast, the long-term cost increments for a midsize PHEV20 and PHEV40 were estimated at US\$8,000 and US\$11,000 respectively. Without knowing the future costs of petroleum, it is impossible to determine the future economics of PHEVs. But it does seem likely, based on the results of this study, that it will be quite a challenge to justify the PHEV capital cost premium on the basis of reduced lifetime energy costs alone. Other incentives and business models may be required to create an attractive value proposition for PHEV motorists. However, the large petroleum reduction potential of PHEVs offers significant national benefits and provides strong justification for governmental support to accelerate the deployment of PHEV technology.



## Acknowledgement

The authors would like to acknowledge the programmatic support of the U.S. Department of Energy Office of Energy Efficiency and Renewable Energy FreedomCAR and Vehicle Technologies Program.

## References

- [1] Sanna, L., "Driving the Solution: The Plug-In Hybrid Vehicle." *EPRI Journal*, 2005.
- [2] California Air Resources Board, "California Exhaust Emission Standards and Test Procedures for 2005 and Subsequent Model Zero-Emission Vehicles, and 2002 and Subsequent Model Hybrid Electric Vehicles, in the Passenger Car, Light-Duty Truck and Medium-Duty Vehicle Classes." California EPA, 2003.
- [3] "Plug-In Hybrids." *California Cars Initiative* online, [www.calcars.org/vehicles.html](http://www.calcars.org/vehicles.html). Accessed July 30, 2006.
- [4] 1995 National Personal Transportation Survey (NPTS), [npts.ornl.gov/npts/1995/doc/index.shtml](http://npts.ornl.gov/npts/1995/doc/index.shtml).
- [5] "Sales Numbers" *hybridCARS.com* online, [www.hybridcars.com/sales-numbers.html](http://www.hybridcars.com/sales-numbers.html). Accessed July 30, 2006.
- [6] *Plug-In Partners* online, <http://www.pluginpartners.org/>. Accessed July 30, 2006.
- [7] Markel, T.; O'Keefe, M.; Gonder, J.; Brooker, A.. *Plug-in HEVs: A Near-term Option to Reduce Petroleum Consumption*. NREL 39415. Golden, CO: National Renewable Energy Laboratory, 2006.
- [8] Wipke, K.B.; Cuddy, M.R.; Burch, S.D. "ADVISOR 2.1: A User-Friendly Advanced Powertrain Simulation Using a Combined Backward/Forward Approach." *IEEE Transactions on Vehicular Technology*; Vol 48, No. 6, 1999; pp. 1751-1761.
- [9] Rush, D. *Market Characterization for Light Duty Vehicle Technical Targets Analysis*, National Renewable Energy Laboratory, 2003.
- [10] "Honda IMA System/Power Unit." *Honda* online, [world.honda.com/CIVICHYBRID/Technology/NewHondaIMASystem/PowerUnit/index\\_1.html](http://world.honda.com/CIVICHYBRID/Technology/NewHondaIMASystem/PowerUnit/index_1.html), accessed July 30, 2006.
- [11] "PAMVEC Model." *University of Queensland Sustainable Energy Research Group* online, [www.itee.uq.edu.au/~serl/PAMVEC.html](http://www.itee.uq.edu.au/~serl/PAMVEC.html), accessed July 30, 2006.
- [12] Rosenkrantz, K. "Deep-Cycle Batteries for Plug-In Hybrid Application." *EVS20 Plug-In Hybrid Vehicle Workshop*, Long Beach, 2003.
- [13] "Multi-Year Program Plan." *FreedomCAR and Vehicle Technologies Program* online. [http://www.eere.energy.gov/vehiclesandfuels/resources/fcvt\\_mypp.html](http://www.eere.energy.gov/vehiclesandfuels/resources/fcvt_mypp.html), accessed July 30, 2006.
- [14] Graham, R. et al. "Comparing the Benefits and Impacts of Hybrid Electric Vehicle Options." *Electric Power Research Institute* (EPRI), 2001.
- [15] Delucchi, M. "Electric and Gasoline Vehicle Lifecycle Cost and Energy-Use Model." *Institute of Transportation Studies*. University of California, Davis, 2000.
- [16] Markel, T.; Simpson, A.; "Plug-In Hybrid Electric Vehicle Energy Storage System Design," *Proc. Advanced Automotive Battery Conference*; 2006, Baltimore, Maryland.
- [17] Gonder, J.; Simpson, A. "Measuring and Reporting Fuel Economy of Plug-In Hybrid Electric Vehicles," *22nd International Battery, Hybrid and Fuel Cell Electric Vehicle Symposium & Exposition*; 2006, Yokohama.
- [18] "SAE J1711 – Recommended Practice for Measuring Fuel Economy of Hybrid-Electric Vehicles." *Society of Automotive Engineers Surface Vehicle Recommended Practice*. Society of Automotive Engineers, Warrendale, 1999.
- [19] *U.S. Energy Information Administration* online, [www.eia.doe.gov](http://www.eia.doe.gov), accessed July 30, 2006.

## Author



Andrew Simpson, Vehicle Systems Engineer, National Renewable Energy Laboratory (NREL), 1617 Cole Blvd, Golden CO 80401 USA; Tel: 303-275-4430; Fax: 303-275-4415; [andrew\\_simpson@nrel.gov](mailto:andrew_simpson@nrel.gov). Andrew joined the Advanced Vehicle Systems Group at NREL in 2005 and his current focus is plug-in hybrid-electric vehicles. He holds a Bachelor of Mechanical Engineering (2000) and Ph.D. in Electrical Engineering (2005) from the University of Queensland, Brisbane, Australia. Prior to NREL, Andrew worked as a CFD consultant for Maunsell Australia. He also co-founded the Sustainable Energy Research Group at The University of Queensland and was a coordinating member of the University's "SunShark" solar car team which raced successfully from 1996-2000.

## Section 2.3

**Title:** “Plug-In Hybrid Electric Vehicles: Current Status, Long-Term Prospects, and Key Challenges”

**Type:** Presentation

**Authors:** Matthew Thornton, Tony Markel, Andrew Simpson, Jeff Gonder, Aaron Brooker

**Date:** July 20, 2006

**Conference or Meeting:** Presented at the Federal Network for Sustainability Meeting at Idaho National Laboratory

**Abstract:** Provides an overview of PHEV technology, technical challenges, and systems analysis efforts



# Plug-in Hybrid Electric Vehicles

## Current Status, Long-Term Prospects and Key Challenges

**Matthew Thornton**

Tony Markel, Andrew Simpson, Jeff Gonder, Aaron Brooker

*Federal Network for Sustainability Meeting  
July 20, 2006*

*Idaho National Laboratory*

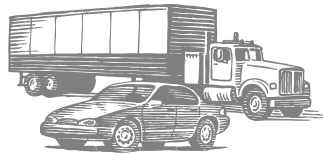

U.S. Department of Energy  
FreedomCAR and Vehicle Technologies Program  
Vehicle Systems Subprogram  
Vehicle Systems Analysis Activity  
Lee Slezak, Technology Manager

### Disclaimer and Government License

This work has been authored by Midwest Research Institute (MRI) under Contract No. DE-AC36-99GO10337 with the U.S. Department of Energy (the "DOE"). The United States Government (the "Government") retains and the publisher, by accepting the work for publication, acknowledges that the Government retains a non-exclusive, paid-up, irrevocable, worldwide license to publish or reproduce the published form of this work or allow others to do so, for Government purposes.

Neither MRI, the DOE, the Government, nor any other agency thereof, nor any of their employees, makes any warranty, express or implied, or assumes any liability or responsibility for the accuracy, completeness, or usefulness of any information, apparatus, product, or process disclosed, or represents that its use would not infringe any privately owned rights. Reference herein to any specific commercial product, process, or service by trade name, trademark, manufacturer, or otherwise does not constitute or imply its endorsement, recommendation, or favoring by the Government or any agency thereof. The views and opinions of the authors and/or presenters expressed herein do not necessarily state or reflect those of MRI, the DOE, the Government, or any agency thereof.

## The Perfect Storm

- Petroleum **consumption** has steadily **increased** while domestic **production** has continued to **decline**
- World oil **production** predicted to **peak** within the next 5-15 years
- Recent increase in **gasoline price** is indicator of **growing tension** between supply and demand

Gasoline price - 85% rise in 5 years!

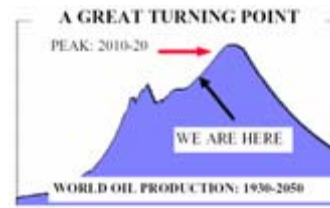
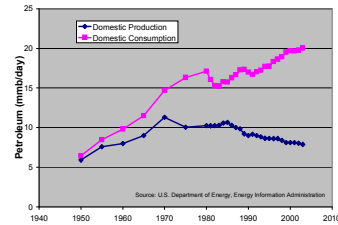
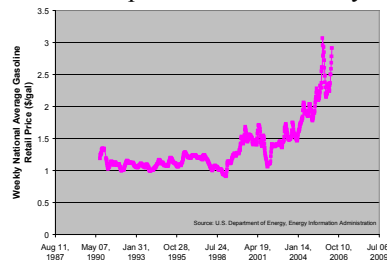

**WHAT'S OUR PLAN?**

3

## America's Oil Addiction



*"America is addicted to oil..."*

- Transportation sector nearly 100% petroleum dependent
- Transportation accounts for two-thirds of total petroleum consumption
- 58% of petroleum is imported

The President's Advanced Energy Initiative Goals:  
Fueling Our Vehicles

1. Develop advanced battery technologies that allow a plug-in hybrid-electric vehicle to have a 40-mile range operating solely on battery charge
2. Foster the breakthrough technologies needed to make cellulosic ethanol cost-competitive with corn-based ethanol by 2012.
3. Accelerate progress towards the President's goal of enabling large numbers of Americans to choose hydrogen fuel cell vehicles by 2020.

4

Source: www.whitehouse.gov



## A "Full" Hybrid

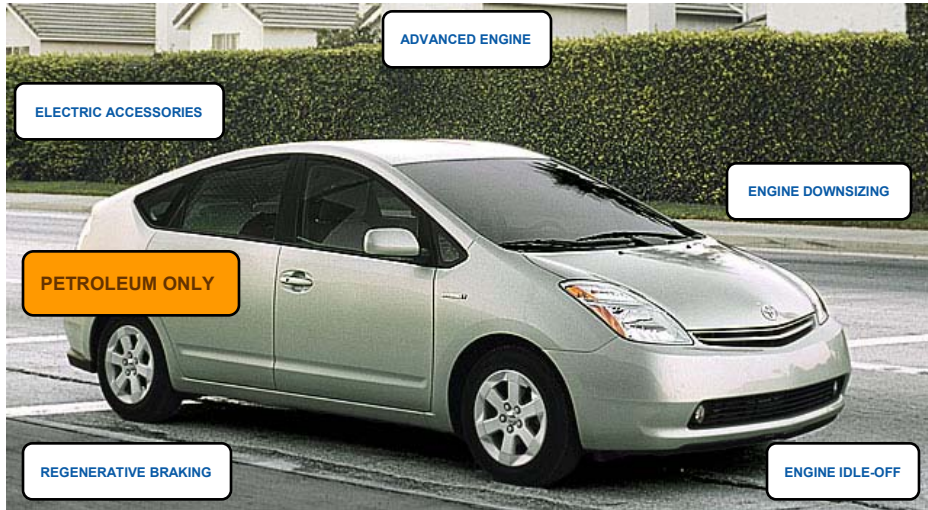

76hp gasoline engine, 67hp electric motor, 1.5kWh battery

5



## Contemporary Hybrids



Toyota Camry



Toyota Prius



Toyota Highlander



Honda Insight



Honda Civic



Honda Accord



Lexus RX400h



Lexus GS450h



Saturn Vue



Ford Escape



Chevy Silverado

6



# A Plug-In Hybrid

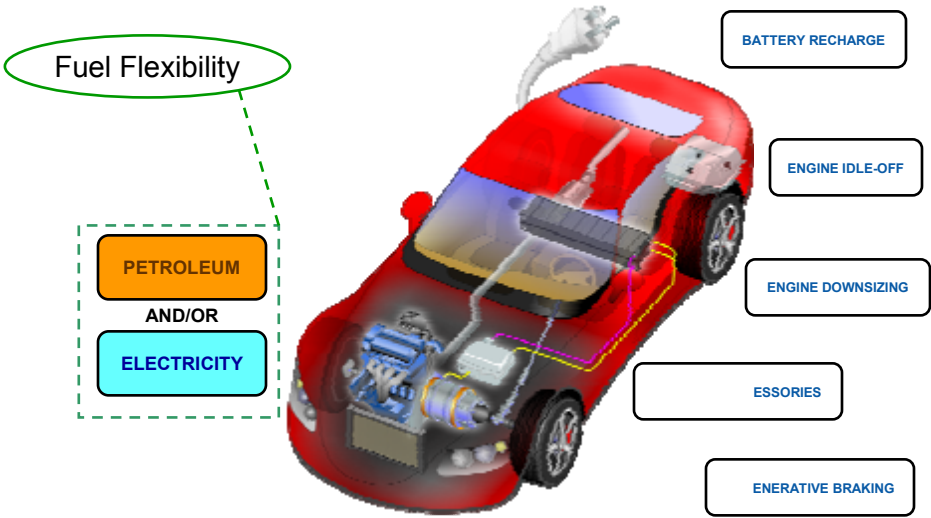

76hp gasoline engine, 67hp electric motor, 9.0kWh battery (30mi)

7

# OEM Plug-In Hybrids



**2003 Renault Kangoo Elect'road**  
 - up to 50mi electric range  
 - approximately 500 sold in Europe

**Renault Cleanova**  
 - Max range 329 miles with 5.3 gallons of fuel



**DaimlerChrysler Sprinter PHEV**  
 - 15 prototypes being produced for testing in various locations in Europe and North America  
 - up to 20mi electric range

8

## Other PHEV Prototypes - Industry



EnergyCS Plug-In Prius



HyMotion Escape PHEV

9



## Oil Use Reduction with HEVs

Light Duty Fleet Oil Use - Impact of HEVs on Consumption

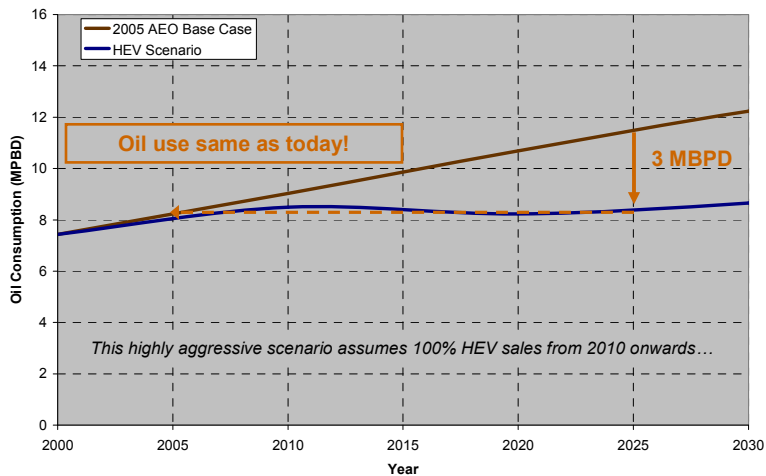

HEVs unable to reduce consumption below today's consumption level

10

Produced using VISION model, MBPD = million barrels per day



# Oil Use Reduction with PHEVs

Light Duty Fleet Oil Use - Impact of PHEVs on Consumption

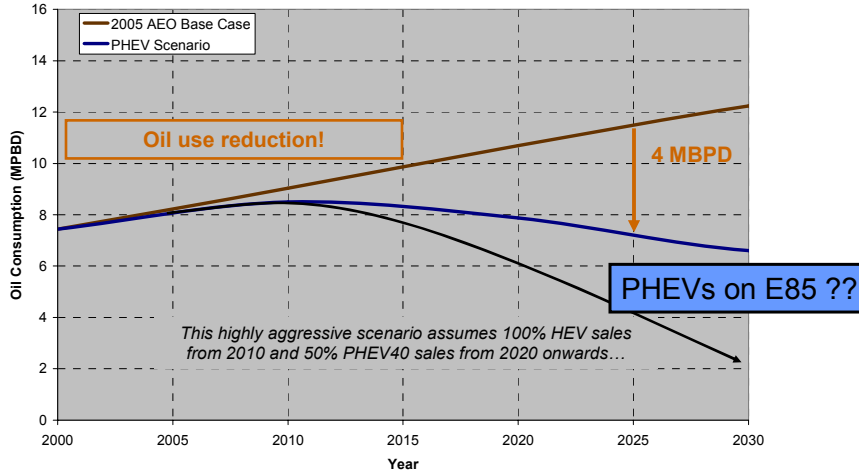

PHEVs reduce oil consumption with a transition to electricity

11

Produced using VISION model, MBPD = million barrels per day



## Design Options All-Electric vs Blended Strategy

All-Electric

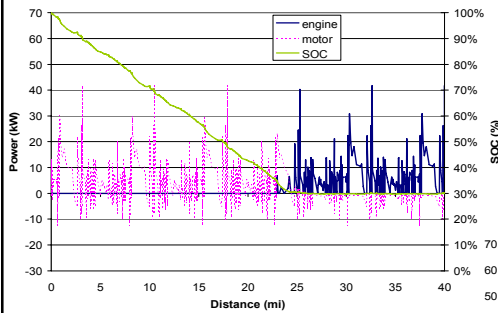

- Engine turns on when battery reaches low state of charge
- Requires high power battery and motor

- Engine turns on when power exceeds battery power capability
- Engine only provides load that exceeds battery power capability

Blended

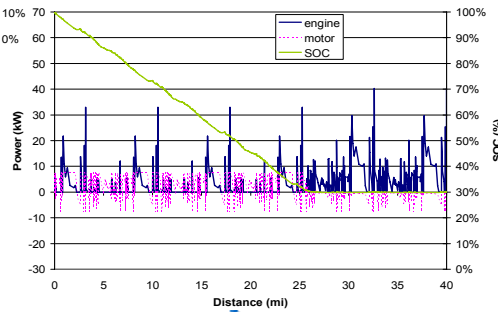

12





## Plug-In Hybrid Fuel Economy

Predicted fuel economy and operating costs for midsize sedan<sup>1</sup>

Vehicle Type	Gasoline Fuel Economy	Electricity Use	Annual Energy Use	Annual Energy Cost	Recharge Time <sup>3</sup>
Conventional	27 mpg	---	564 gal.	\$1360	---
Hybrid-Electric	36 mpg	---	416 gal.	\$1000	---
Plug-In Hybrid 20mi range	51 mpg	0.09 kWh/mi	297 gal. and 1394 kWh <sup>2</sup>	\$716 + \$125	< 4 hrs
Plug-In Hybrid 40mi range	69 mpg	0.16 kWh/mi	218 gal. and 2342 kWh <sup>2</sup>	\$525 + \$211	< 8 hrs

- 1) Assumes 15,000 miles annually, gasoline price of \$2.41 per gallon, electricity price of 9c/kWh
- 2) Note that average US household consumes 10,700 kWh of electricity each year
- 3) Using 110V, 20A household outlet

13



## Household Travel Survey Data Can be Used to Predict Real-World Benefits of Advanced Technologies

- Provides valuable insight into travel behavior
- GPS augmented surveys supply details needed for vehicle simulation

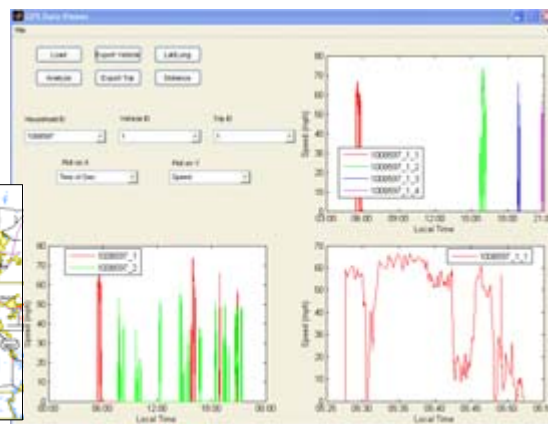

14



## PHEVs Reduce Fuel Consumption By >50% On Real-World Driving Cycles

227 vehicles from St. Louis each modeled as a conventional, hybrid and PHEV

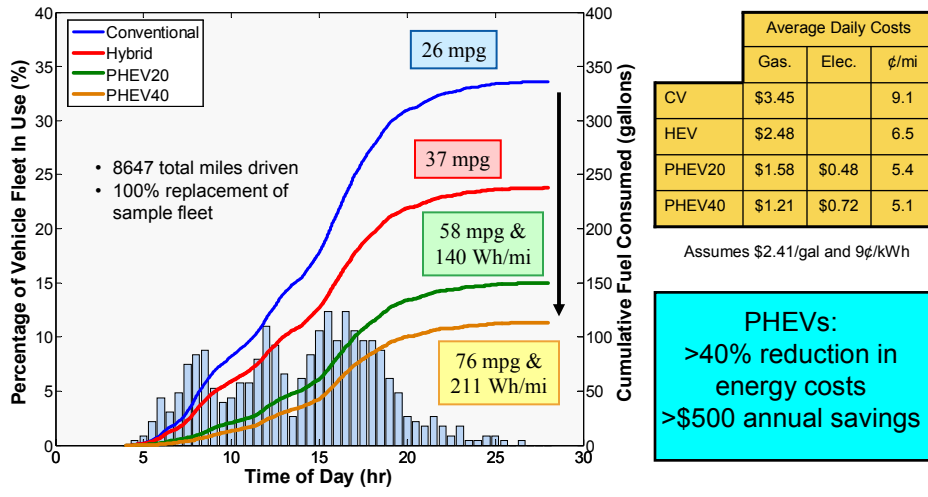

15



## HEVs and PHEVs Likely to Reduce Greenhouse Emissions

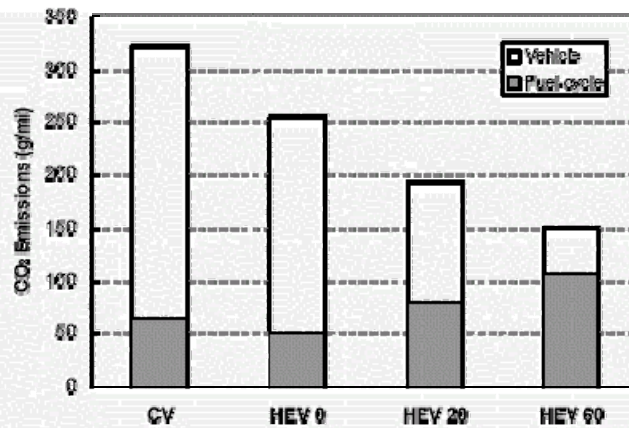

**Figure 2-10**  
 Greenhouse Gas Emissions (CO<sub>2</sub>) "Well-to-Wheels" for the Compact Car for the Average Driving Schedule and Charging Mixture

16

Source: Hybrid Electric Vehicle Working Group, [www.epri.com](http://www.epri.com)



## Electrified Miles May Lead to Cleaner Operation

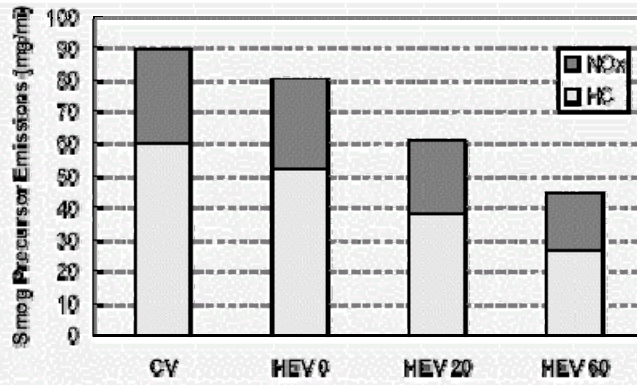

Figure 2-7  
NOx Plus HC (Smog) "Well-to-Wheels" Emissions for the Compact Car for the Average Driving Schedule and Charging Nightly

17 Source: Hybrid Electric Vehicle Working Group, [www.epri.com](http://www.epri.com)



## Technical Challenges Battery Life

- PHEV battery likely to deep-cycle each day driven: 15 yrs equates to 4000-5000 deep cycles
- Also need to consider combination of high and low frequency cycling

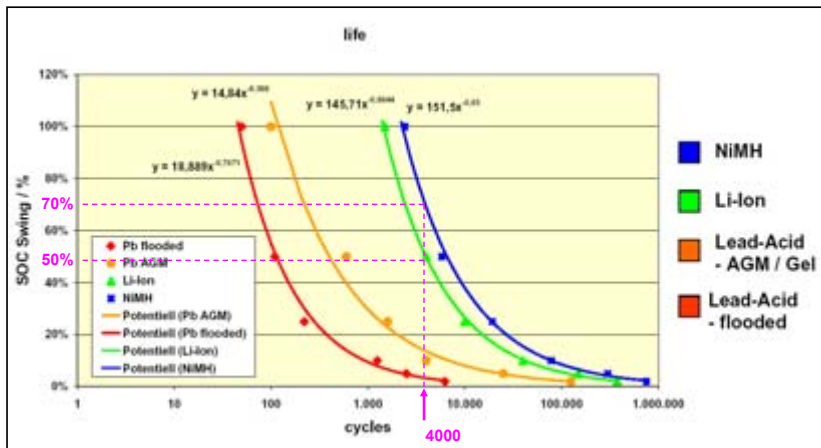

Data presented by Christian Rosenkranz (Johnson Controls) at EVS 20

18



## Technical Challenges Battery Packaging



19



## Technical Challenges Vehicle Costs

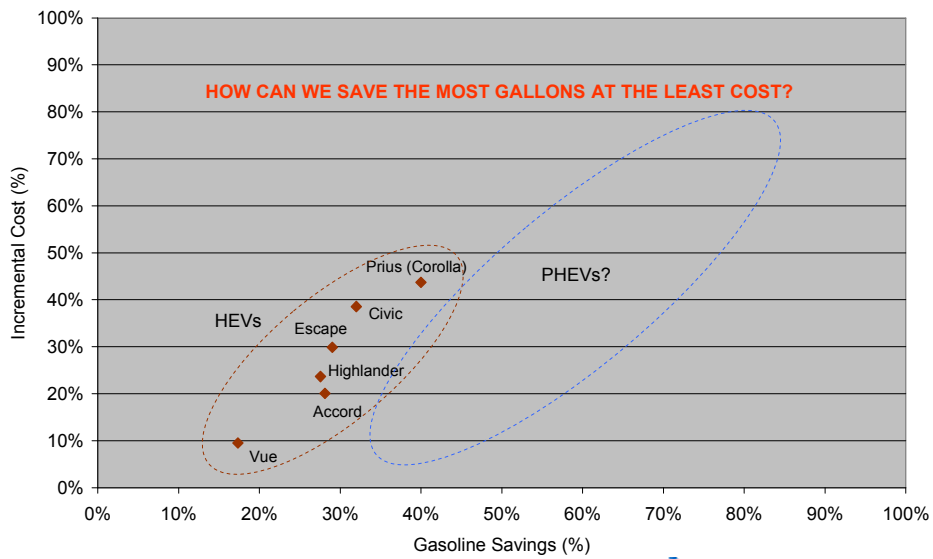

20



## Vehicle Costs

### Projected Retail Powertrain Costs - Midsize Sedans

- 1) including manufacturer and dealer markups
- 2) all component costs assume projected status

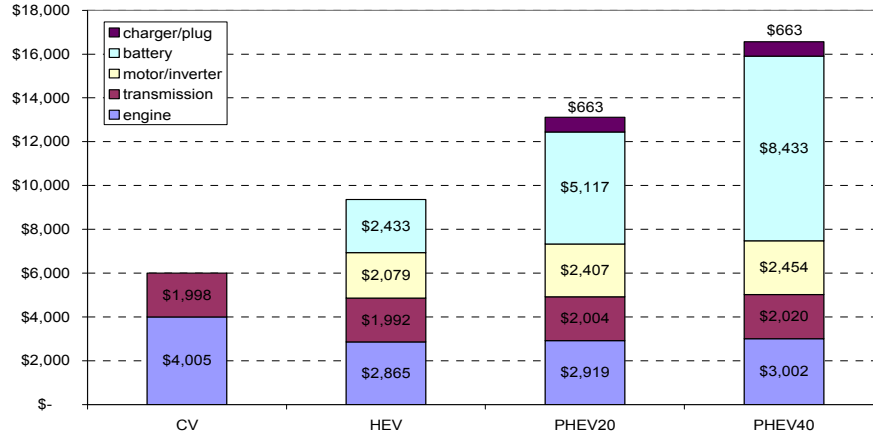

21



## Vehicle Costs cont.

### Cumulative Vehicle plus Energy (Fuel/Elec.) Costs

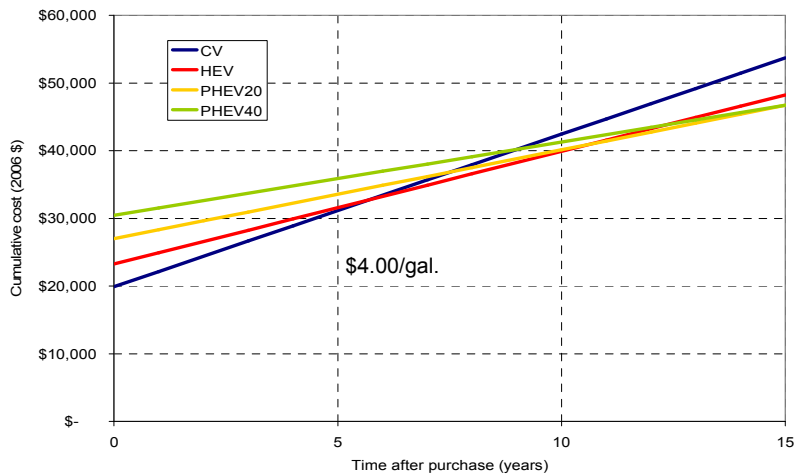

22



## Vehicle Costs cont.

### Why would PHEV buyers pay more?

- Tax incentives
- Reduced petroleum use, air pollution and CO<sub>2</sub>
- National energy security
- Less maintenance
- Reduced fill-ups
- Convenience of home recharging (off-peak)
- Improved acceleration (high torque of electric motors)
- Green image, “feel-good factor”

23



## Our Contributions

- Developing Route-Based control strategies that will help extend the life of vehicle batteries
- Evaluating alternative battery usage and ownership scenarios to reduce costs
  - Does it really have to last the life of the vehicle
  - Battery lease or combine with home mortgage
- Using travel data to develop real-world usage pattern to aid in effective system design
- Vehicle thermal management for PHEVs
  - Energy storage – protection for life
  - Cabin – passenger comfort
  - Engine – emissions control

24



## Conclusions

- Plug-in hybrid technology uses electricity from the utility grid to reduce petroleum consumption beyond that of HEV technology
  - Predicted 50% reduction in in-use consumption based on simulations using travel survey data
- Industry interest is growing and some prototypes have been built
  - Collaboration between labs and industry will likely lead to innovative systems solutions
- The U.S. Department of Energy is expanding its research portfolio to include PHEVs
  - Research will address key remaining barriers to commercial PHEVs including battery life, packaging, and cost

## Section 2.4

**Title:** “Plug-In Hybrid Electric Vehicle Energy Storage Analysis”

**Type:** Presentation

**Authors:** Andrew Simpson and Tony Markel

**Date:** July 25, 2006

**Conference or Meeting:** Presented to the FreedomCAR Electrochemical Energy Storage Technical Team PHEV Working Group Meeting

**Abstract:** Provides a summary of cost and consumption benefit analysis as it relates to setting requirements for energy storage systems for PHEVs



# Plug-In Hybrid Electric Vehicle Energy Storage Analysis

(with implications for vehicle fuel economy and cost)

By

**Andrew Simpson and Tony Markel**  
Vehicle Systems Analysis Team  
National Renewable Energy Laboratory

Plug-In Hybrid Battery Workgroup Meeting  
Electrochemical Energy Storage Tech Team  
USCAR, Southfield, MI

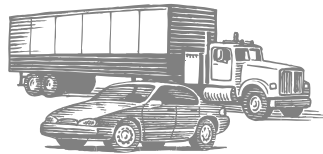

July 25, 2006

With support from  
Lee Slezak, Vehicle Systems Program  
FreedomCAR and Vehicle Technologies Program  
Office of Energy Efficiency and Renewable Energy  
U.S. Department of Energy

## Disclaimer and Government License

This work has been authored by Midwest Research Institute (MRI) under Contract No. DE-AC36-99GO10337 with the U.S. Department of Energy (the "DOE"). The United States Government (the "Government") retains and the publisher, by accepting the work for publication, acknowledges that the Government retains a non-exclusive, paid-up, irrevocable, worldwide license to publish or reproduce the published form of this work or allow others to do so, for Government purposes.

Neither MRI, the DOE, the Government, nor any other agency thereof, nor any of their employees, makes any warranty, express or implied, or assumes any liability or responsibility for the accuracy, completeness, or usefulness of any information, apparatus, product, or process disclosed, or represents that its use would not infringe any privately owned rights. Reference herein to any specific commercial product, process, or service by trade name, trademark, manufacturer, or otherwise does not constitute or imply its endorsement, recommendation, or favoring by the Government or any agency thereof. The views and opinions of the authors and/or presenters expressed herein do not necessarily state or reflect those of MRI, the DOE, the Government, or any agency thereof.

## NREL's Plug-in HEV R&D Activities

- **Battery Level**
  - R&D support to developers
  - Testing and evaluation
  - EPRI/Sprinter PHEV testing
  - Thermal characterization and design
- **Vehicle Level**
  - Real-world PHEV simulations - fuel economy and recharging
  - Development of test procedures for PHEVs and MPG reporting
  - Evaluation of alternative PHEV design strategies
  - PHEV design cost-benefit analysis
- **Utility Level**
  - Assessment of PHEV impacts on utilities
  - Exploring synergies between PHEVs and wind power
  - V2G opportunities for PHEVs in regulation services
- **National Level**
  - Benefits assessment - oil use and emissions
  - Renewable community – linking PHEV to renewable
- **Analysis support to DOE, OEMs, and others**
  - Working to identify and overcome barriers to PHEV adoption



Secretary of Energy visiting NREL on 7/17/06 for ribbon cutting of the new S&T Facility and then discussing plug-in hybrids with EnergyCS & Hymotion

3



## Key Messages

In setting energy storage requirements for PHEVs, we need to consider:

1. There is a VERY large spectrum of PHEV designs
2. There is a link between SOC window, driving habits and cycle life that impacts energy storage size and cost
3. A wide range of P/E ratios may be needed
4. Tradeoffs between fuel economy / oil displacement and powertrain mass, volume and cost

**Fundamental Question:**

What kind of PHEV are we setting requirements for?

4



## Some PHEV Definitions

**Charge-Depleting (CD) Mode:** An operating mode in which the energy storage SOC may fluctuate but on-average decreases while driving

**Charge-Sustaining (CS) Mode:** An operating mode in which the energy storage SOC may fluctuate but on-average is maintained at a certain level while driving

**All-Electric Range (AER):** After a full recharge, the total miles driven electrically (engine-off) before the engine turns on for the first time.

**Zero Emission Vehicle (ZEV) Range:** The same as all-electric range (AER), no tail-pipe emissions during EV mode. To qualify for CARB ZEV, the minimum ZEV or AER should be 10 miles during the UDDS drive cycle.

**EV, HEV and Blended Modes and Range:**

**Electric Vehicle Miles (EVM):** After a full recharge, the total miles driven electrically (engine-off) before the vehicle reaches charge-sustaining mode

**Charge-Depleting Range (CDR):** After a full recharge, the total miles driven before the vehicle reaches charge-sustaining mode.

**PHEV20:** A PHEV with useable energy storage equivalent to 20 miles of driving energy on a reference driving cycle. The PHEV20 can displace petroleum energy equivalent to 20 miles of driving on the reference cycle with off-board electricity.

**NOTE:** PHEV20 does not imply that the vehicle will achieve 20 miles of AER, EVM or CDR on the reference cycle nor any other driving cycle. Operating characteristics also depend on the power ratings of components, the powertrain control strategy and the nature of the driving cycle

5



## PHEV Architectures

A PHEV can be implemented using any of the HEV architectures (parallel, series or power-split).

The two things that differentiate PHEVs from HEVs are a CD operating mode and a recharging plug.

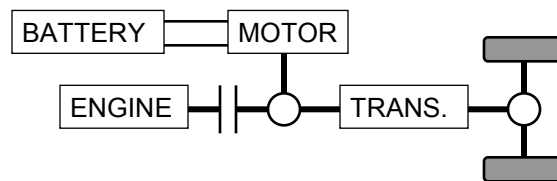

The results shown in this presentation are for a parallel PHEV.

6



## PHEV Design Strategies: All-Electric vs Blended

All-Electric

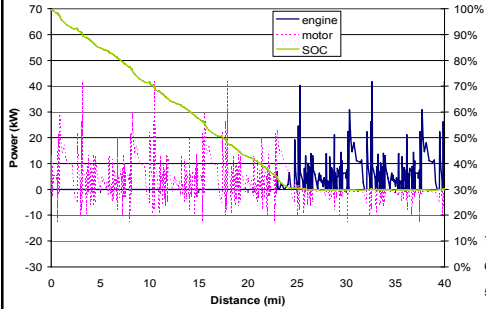

- ← Requires higher-power battery and motor
- ← Engine turns on when battery reaches CS state of charge

- Uses lower-power battery and motor
- Engine turns on when power request exceeds battery power limit

Blended

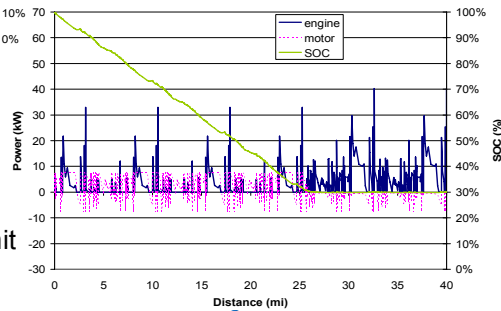

7

## PHEV Design Strategies (cont.)

Benefits of using a blended strategy:

Lower power to energy ratio leads to lighter, smaller, and cheaper energy storage system.

Battery Design Functions

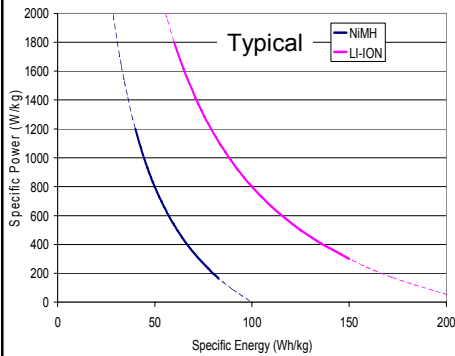

Battery Module Cost Functions

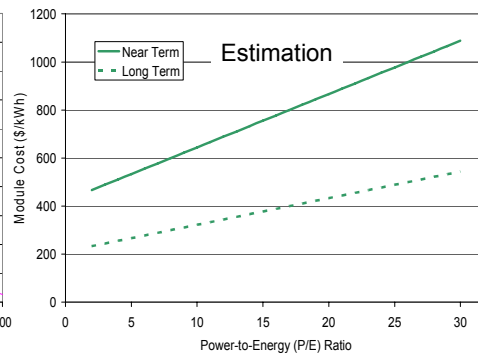

8

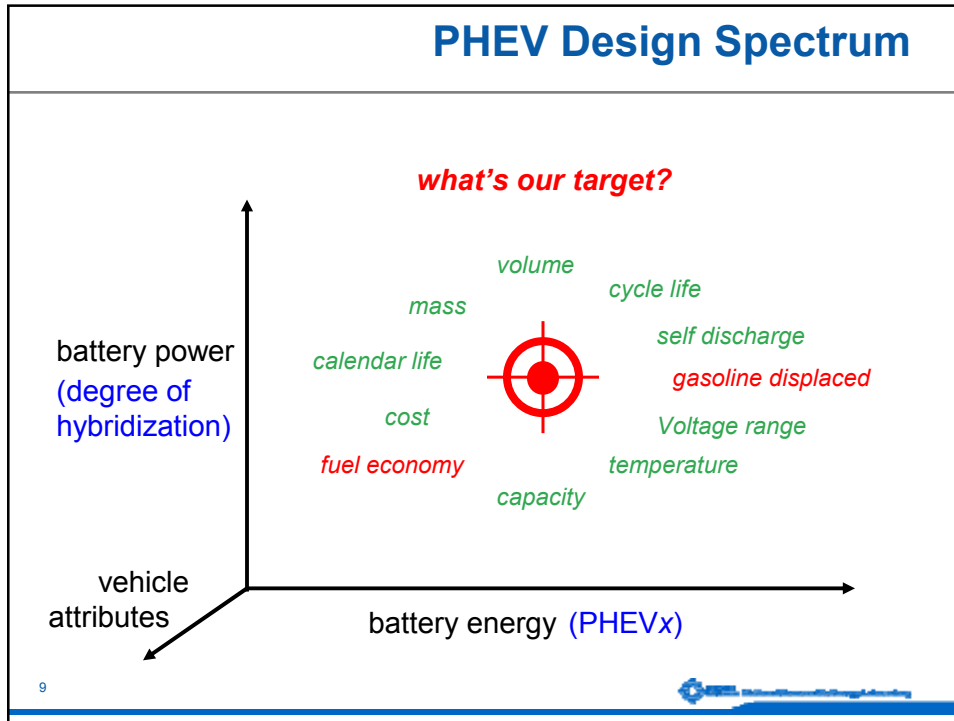

## Exploring the PHEV Design Spectrum

Ongoing NREL study using validated CV/HEV/PHEV simulation model

**Key Inputs:**

- Vehicle platforms and performances
- SOC design window
- Control strategy
- Battery performance and cost models
- Other component performance and cost models

10

## Baseline Vehicle Characteristics – Midsize Sedan

MIDSIZE SEDAN (AUTOMATIC)	
<b>Platform Parameters</b>	
Glider Mass	905 kg
Curb Mass	1429 kg
Test Mass	1565 kg (136 kg load)
Gross Vehicle Mass (GVM)	1899 (470 kg load)
Drag coefficient	0.30
Frontal area	2.27m <sup>2</sup>
Rolling resistance coefficient	0.009
Baseline accessory load	800 W elec. + 2900 W A/C
<b>Performance Parameters</b>	
Standing acceleration	0-60 mph in 8.0 s
Passing acceleration	40-60 mph in 5.3 s
Top speed	110 mph
Gradeability	6.5% at 55 mph at GVM with 2/3 fuel converter power
<b>Vehicle attributes</b>	
Engine power	121 kW
Fuel economy	22.2 / 35.2 / 26.6 mpg (urban / highway / composite, unadjusted)



Under review/recommendation by VSATT

11



## Baseline Vehicle Characteristics – Midsize SUV

MIDSIZE SUV (AUTOMATIC 4WD)	
<b>Platform Parameters</b>	
Glider Mass	1280 kg
Curb Mass	2015 kg
Test Mass	2151 kg (136 kg load)
Gross Vehicle Mass (GVM)	2667 (516 kg load)
Drag coefficient	0.41
Frontal area	2.88m <sup>2</sup>
Rolling resistance coefficient	0.009
Baseline accessory load	1200 W elec. + 4000 W A/C
<b>Performance Parameters</b>	
Standing acceleration	0-60 mph in 8.4 s
Passing acceleration	40-60 mph in 5.3 s
Top speed	110 mph
Gradeability	6.5% at 55 mph at GVM with 2/3 fuel converter power
<b>Vehicle attributes</b>	
Engine power	178 kW
Fuel economy	15.6 / 24.0 / 18.5 mpg (urban / highway / composite, unadjusted)



Under review/recommendation by VSATT

12



# Battery Definition as Key Input to Simulation

Input parameters that define the battery in BLUE

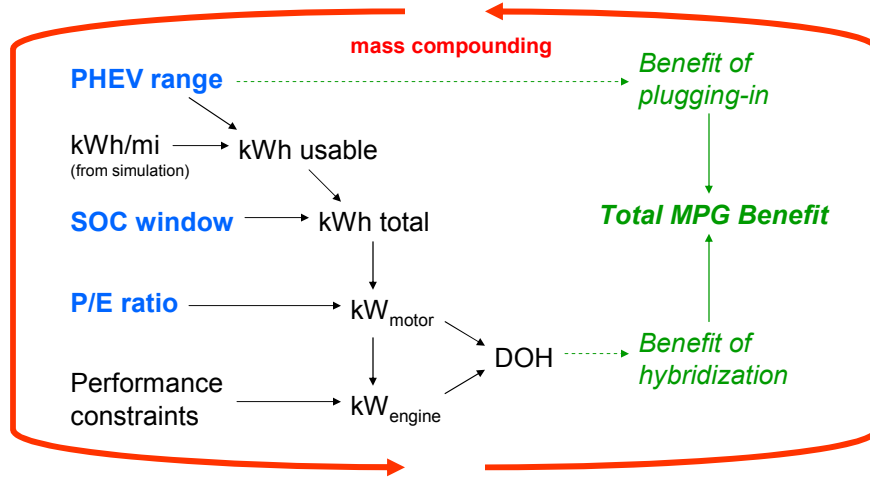

13

DOH = degree of hybridization



# Battery SOC Design Window

In setting requirements, we must have realistic expectations for battery SOC design window because of the impacts on total battery size and life.

SOC design window is a key factor in battery sizing:

$$kWh_{total} = \frac{kWh_{useable}}{SOC\ window}$$

Battery SOC swing is a strong function of driving habits:

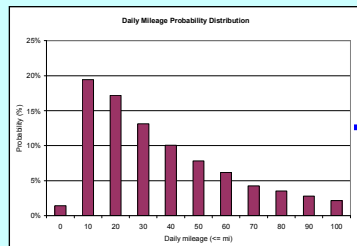

Battery cycle life is a strong function of SOC swing:

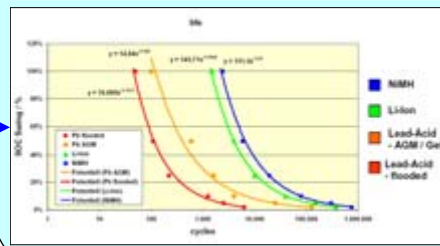

14



## Battery SOC Design Window

In this hypothetical example, all PHEVs use the same SOC design window. However, because of the daily mileage distribution, the low range PHEV batteries experience more-severe cycling and are likely to fail sooner.

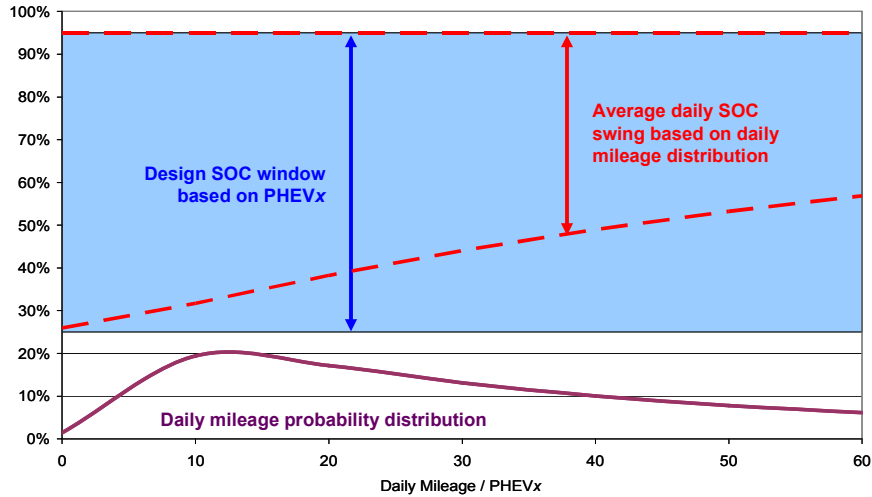

15



## Battery SOC Design Window (cont.)

In this hypothetical example, PHEVs use a different SOC design window based on their PHEVx design range. This produces consistent cycling across the range of PHEVs resulting in consistent expectations for battery life.

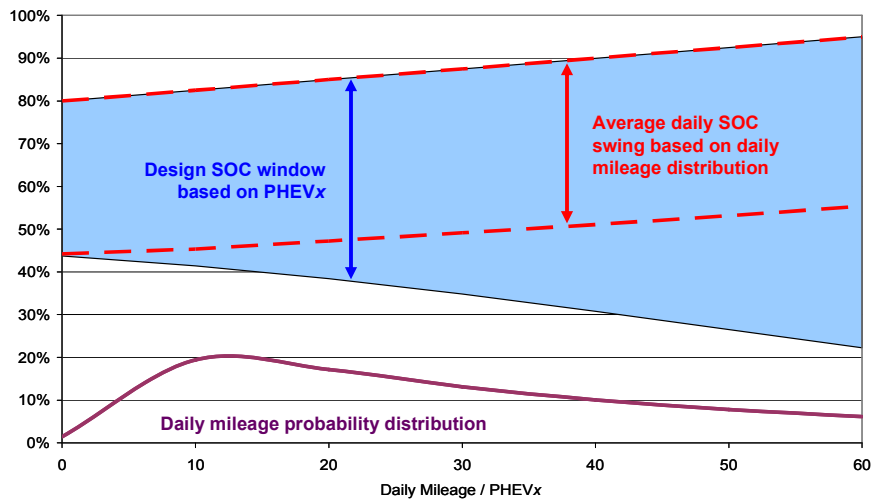

16





# Battery Models (Scaleable)

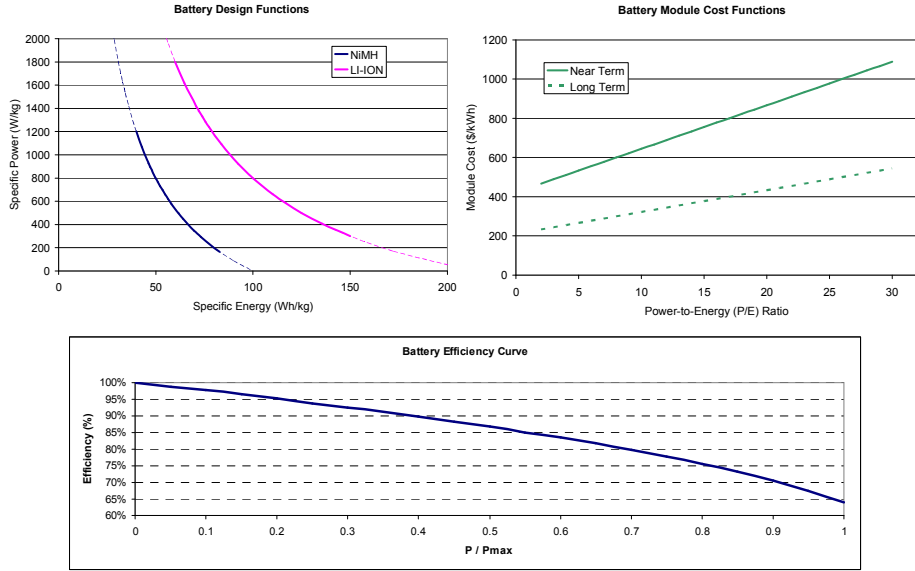

17



# Results: All-Electric Range

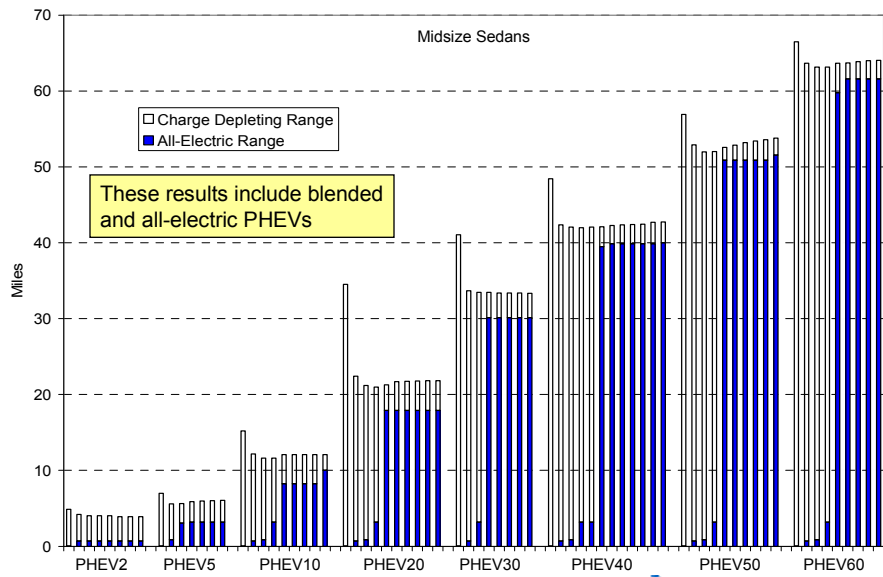

18



## Results: Useable Battery Energy

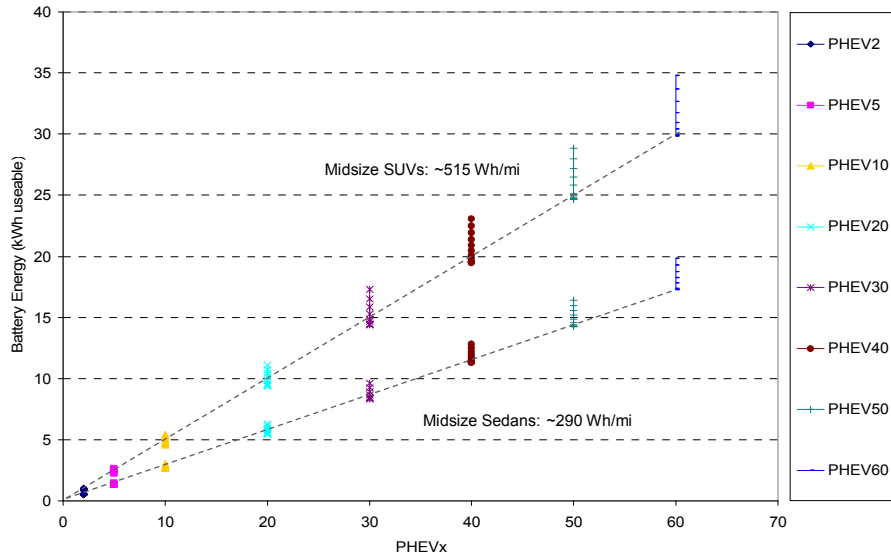

19



## Results: Battery Specifications

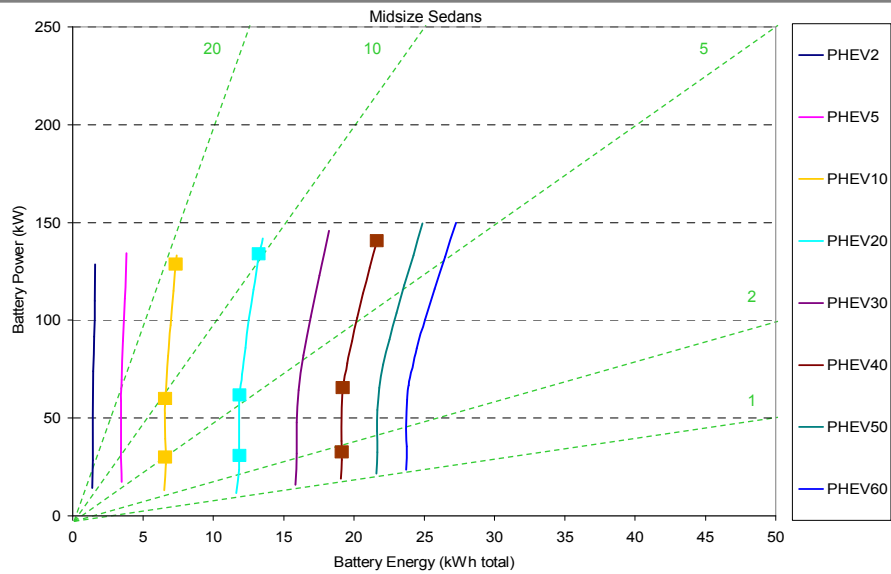

20



## Results: Battery Specifications

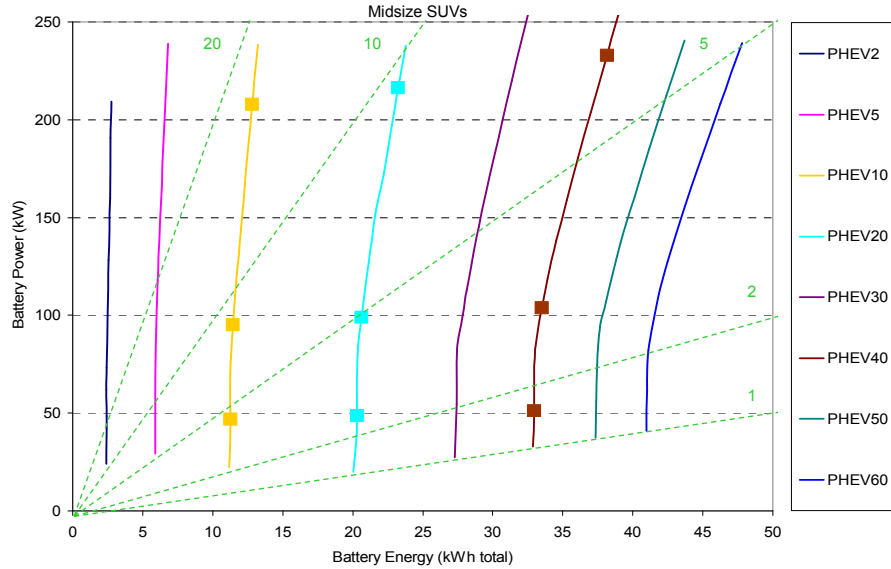

21



## PHEV Battery Options

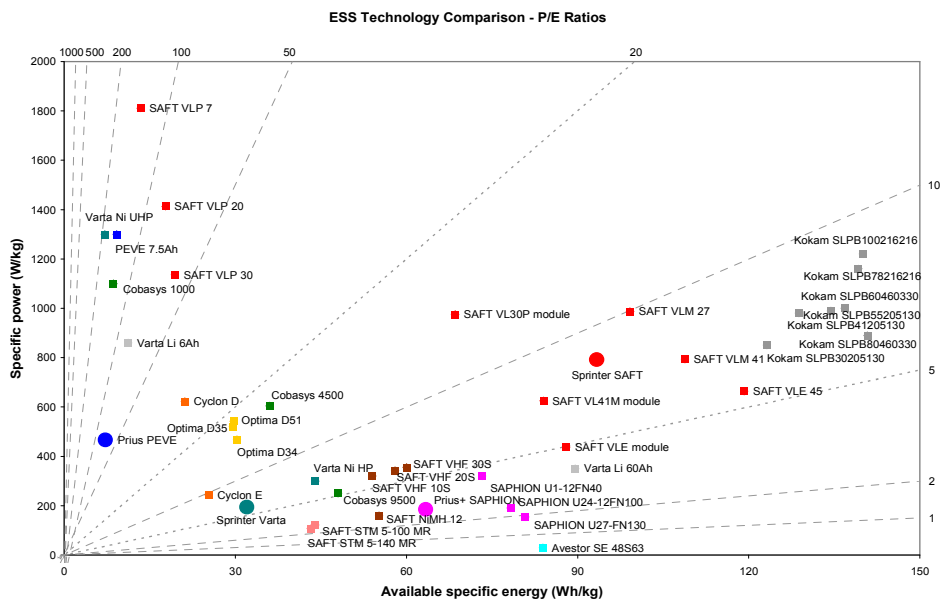

22



## Results: Power-to-Energy Ratio

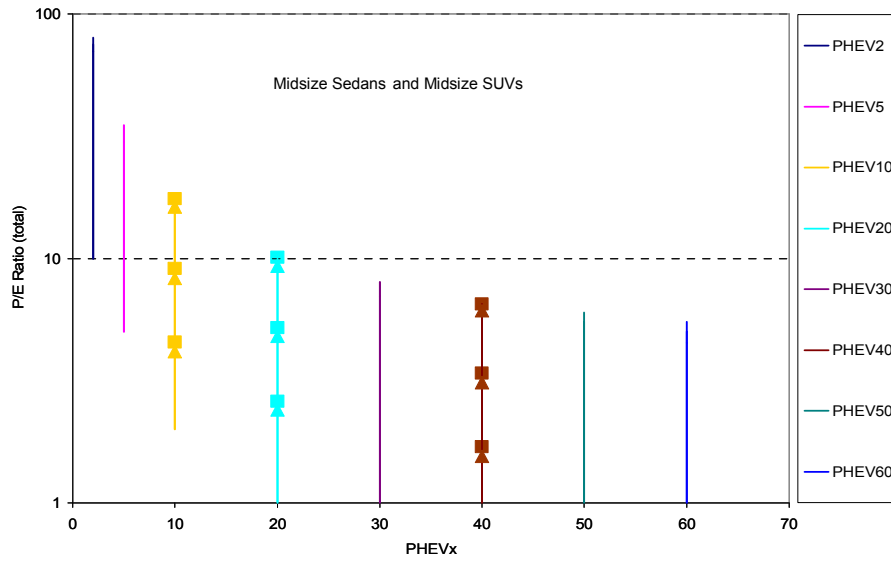

23

## Results: Midsize Sedans

Vehicle	Curb Mass (kg)	Vehicle Cost	Engine (kW)	Motor (kW)	DOH (%)	P/E (1/h)	Battery (kWh)	SOC (%)	Fuel Use (mpg)	Elec. Use (Wh/mi)
CV	---	\$ 23,392	121.7	---	---	---	---	---	26.6	---
HEV downsized	1416	\$ 26,790	75.0	38.7	34%	39.0	1.4	37%	36.0	0.0
PHEV10 blended	1494	\$ 29,071	100.1	19.1	16%	4.6	6.6	41%	38.3	52.0
PHEV10 UDDS AER	1483	\$ 29,698	77.0	41.8	35%	9.1	6.6	41%	42.3	51.9
PHEV10 US06 AER	1584	\$ 32,862	80.2	93.8	54%	17.5	7.3	41%	38.7	57.4
PHEV20 blended	1542	\$ 31,238	102.8	19.7	16%	2.6	11.9	47%	44.0	95.9
PHEV20 UDDS AER	1536	\$ 31,885	78.9	43.1	35%	5.2	11.9	47%	50.1	95.1
PHEV20 US06 AER	1657	\$ 35,458	82.5	97.8	54%	10.1	13.3	47%	45.7	104.4
PHEV40 blended	1605	\$ 34,237	105.9	21.0	17%	1.7	19.1	59%	55.3	160.5
PHEV40 UDDS AER	1604	\$ 34,970	81.0	45.9	36%	3.4	19.2	59%	69.0	157.3
PHEV40 US06 AER	1750	\$ 39,095	85.4	102.9	55%	6.5	21.6	59%	63.2	173.4

↑  
projected battery costs

24

## Results: Midsize SUVs

Vehicle	Curb Mass (kg)	Vehicle Cost	Engine (kW)	Motor (kW)	DOH (%)	P/E (1/h)	Battery (kWh)	SOC (%)	Fuel Use (mpg)	Elec. Use (Wh/mi)
CV	2015	\$ 29,400	184.0	---	---	---	---	---	18.5	---
HEV downsized	2002	\$ 33,175	129.2	41.7	24%	25.7	2.4	37%	23.4	0.0
PHEV10 blended	2111	\$ 37,198	148.9	30.1	17%	4.2	11.3	41%	25.8	89.3
PHEV10 UDDS AER	2138	\$ 38,743	129.9	66.7	34%	8.3	11.4	41%	27.1	90.3
PHEV10 US06 AER	2296	\$ 43,905	130.8	152.3	54%	16.2	12.8	41%	25.4	100.4
PHEV20 blended	2194	\$ 40,944	153.7	31.6	17%	2.4	20.3	47%	29.3	165.2
PHEV20 UDDS AER	2224	\$ 42,528	130.4	69.8	35%	4.8	20.6	47%	32.3	165.9
PHEV20 US06 AER	2415	\$ 48,378	132.3	158.7	55%	9.3	23.3	47%	30.3	183.1
PHEV40 blended	2303	\$ 46,170	160.0	33.4	17%	1.6	33.0	59%	36.9	279.5
PHEV40 UDDS AER	2334	\$ 47,787	131.0	73.5	36%	3.1	33.5	59%	44.5	276.6
PHEV40 US06 AER	2586	\$ 55,058	138.4	171.2	55%	6.1	38.2	59%	41.1	305.9

↑  
projected battery costs

25



## Results: Curb Mass

Reduction in Fuel Consumption vs Curb Mass

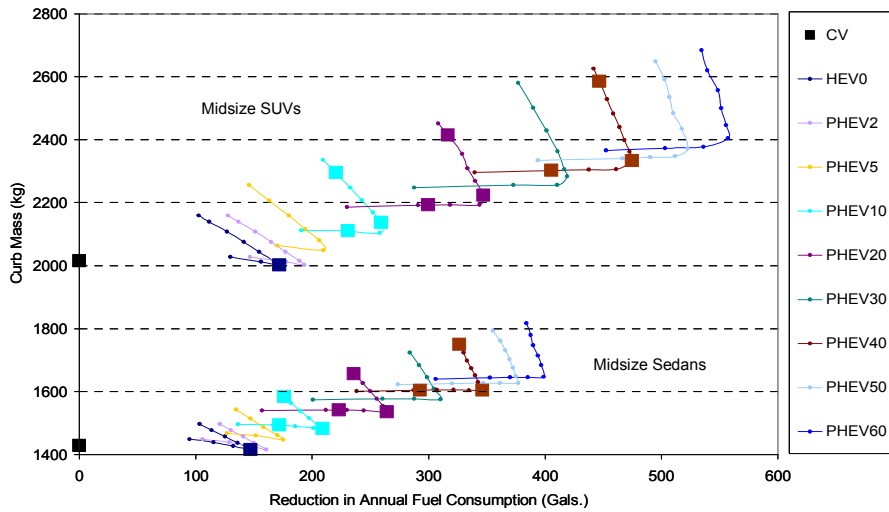

26



## Results: Powertrain Volume

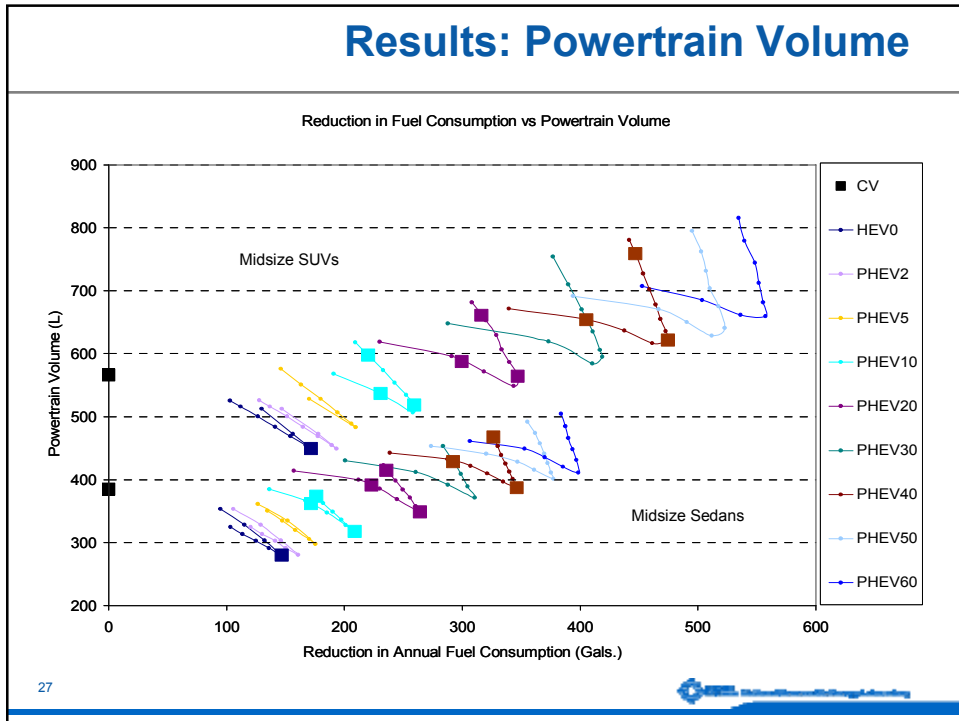

## Results: Battery Volume

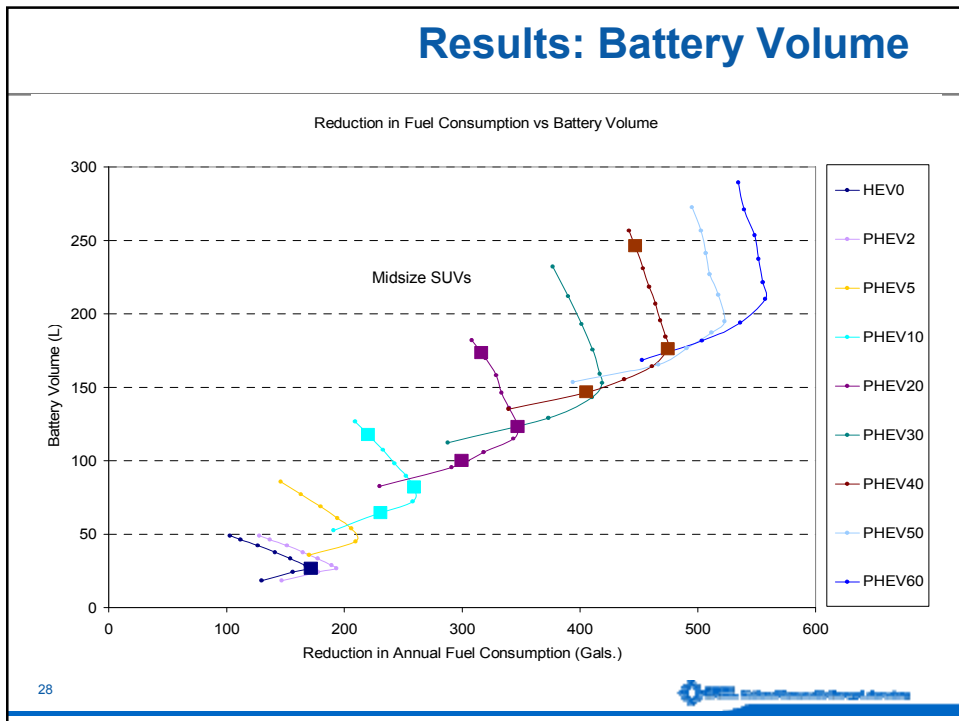

## Results: Vehicle Cost

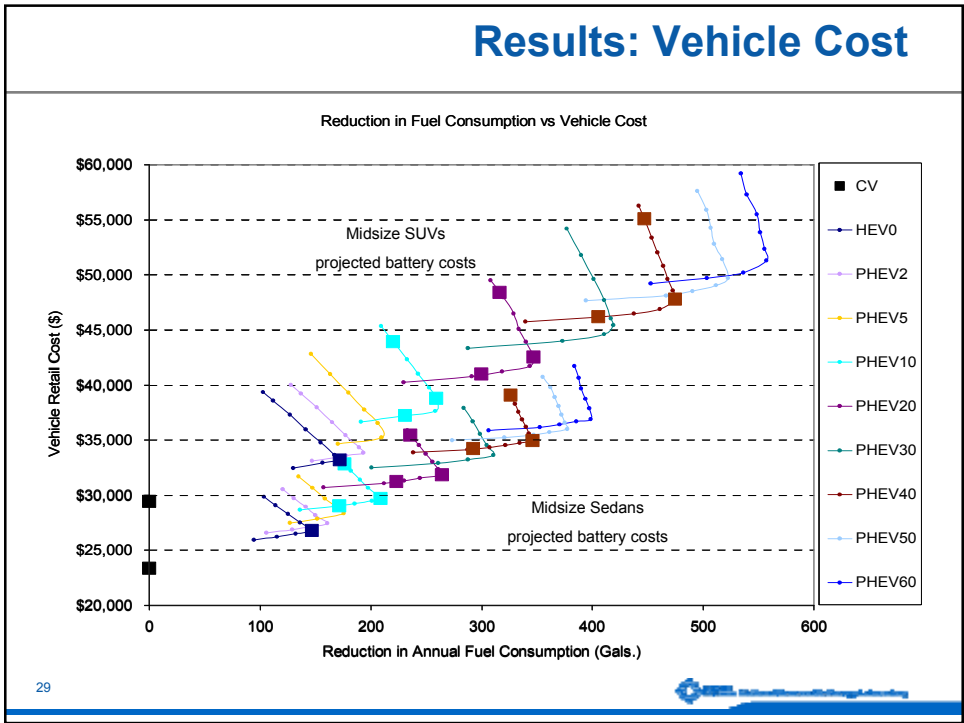

## Results: Vehicle Cost

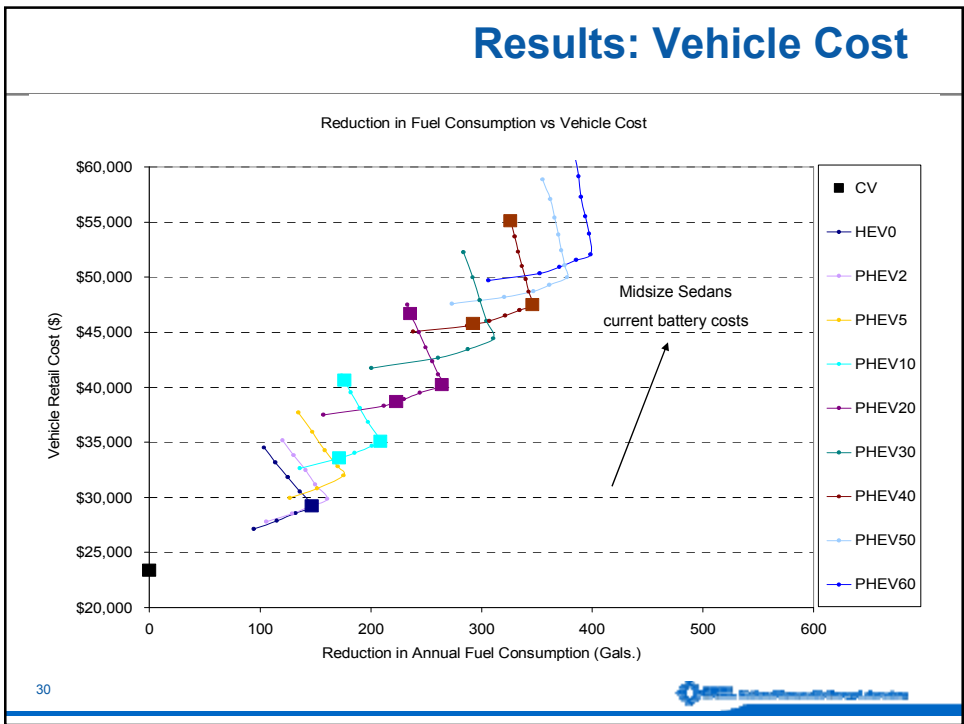

## PHEVs Reduce Fuel Consumption By >50% On Real- World Driving Cycles

227 vehicles from St. Louis each modeled as a conventional, hybrid and PHEV

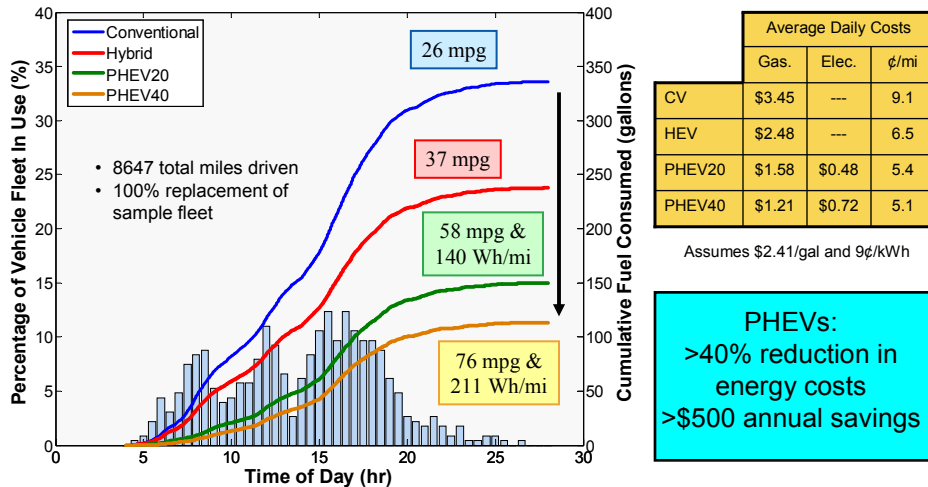

31 Source: Tony Markel, Jeff Gondor, and Andrew Simpson (NREL), Milestone Report, Golden, CO, May 2006

## Fuel Economy and All Electric Range Comparison

- Difference between rated (EPA drive cycles) and Real median values are significant for the PHEVs
  - Consumers likely to observe fuel economy higher than rated value in typical driving
  - Vehicles designed with all electric range likely to operate in a blended mode to meet driver demands

	<i>Fuel Economy (mpg) **</i>		<i>All Electric Range (mi)</i>	
	Rated	Median	Rated	Median
<b>Conventional</b>	26	24.4	n/a	n/a
<b>HEV</b>	39.2	35.8	n/a	n/a
<b>PHEV20</b>	54	70.2	22.3	5.6
<b>PHEV40</b>	67.4	133.6	35.8	3.8

\*\* Fuel economy values do not include electrical energy consumption

32 Source: Tony Markel, Jeff Gonder, and Andrew Simpson (NREL), Milestone Report, Golden, CO, May 2006



## Technical Summary

### Midsize Sedan

Electrical energy use on UDDS: ~290 Wh/mi

Battery power for all-electric UDDS capability: ~60kW

PHEV 10-40 useable energy: 2.7 – 11.4 kWh

PHEV 10-40 total energy: 6.6 – 19.2 kWh

P/E ratio (total energy): 9.1 – 3.4

### Midsize SUV

Electrical energy use on UDDS: ~510 Wh/mi

Battery power for all-electric UDDS capability: ~100kW

PHEV 10-40 useable energy: 4.7 – 19.9 kWh

PHEV 10-40 total energy: 11.4 – 33.5 kWh

P/E ratio (total energy): 8.3 – 3.1

33



## Conclusions and Key Messages

In setting energy storage requirements for PHEVs, we need to consider:

1. There is a VERY large spectrum of PHEV designs
  - Battery energy: 2-50kWh, battery power: 20-250kW
2. There is a link between SOC window, driving habits and cycle life that impacts energy storage size and cost
  - Different PHEVx requires different SOC design window
3. A wide range of P/E ratios may be needed
  - P/E ratios = 1-40
4. Tradeoffs between fuel economy / oil displacement and powertrain mass, volume and cost
  - Blended strategy PHEVs can help reduce battery mass, volume and cost in the near term.
  - In the long term, all-electric PHEVs achieve a target level of oil displacement at the lowest mass, volume and cost

**Fundamental Question:**

**What kind of PHEV are we setting requirements for?**

34



## Section 2.5

**Title:** “Plug-In Hybrid Modeling and Application: Cost/Benefit Analysis”

**Type:** Presentation

**Author:** Andrew Simpson

**Date:** Aug. 24, 2006

**Conference or Meeting:** Presented at the Third AVL Summer Conference on Automotive Simulation Technology: Modeling of Advanced Powertrain Systems

**Abstract:** Includes a brief summary of the cost and consumption benefit analysis

## Plug-in Hybrid Modeling and Application: Cost / Benefit Analysis

*Presented at the 3<sup>rd</sup> AVL Summer Conference on Automotive Simulation Technology:  
Modeling of Advanced Powertrain Systems*

**Andrew Simpson**  
**National Renewable Energy Laboratory**

Thursday, 24<sup>th</sup> August 2006

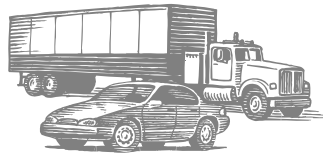

With support from the  
U.S. Department of Energy  
Office of Energy Efficiency and Renewable Energy  
FreedomCAR and Vehicle Technologies Program

### Disclaimer and Government License

This work has been authored by Midwest Research Institute (MRI) under Contract No. DE-AC36-99GO10337 with the U.S. Department of Energy (the "DOE"). The United States Government (the "Government") retains and the publisher, by accepting the work for publication, acknowledges that the Government retains a non-exclusive, paid-up, irrevocable, worldwide license to publish or reproduce the published form of this work, or allow others to do so, for Government purposes.

Neither MRI, the DOE, the Government, nor any other agency thereof, nor any of their employees, makes any warranty, express or implied, or assumes any liability or responsibility for the accuracy, completeness, or usefulness of any information, apparatus, product, or process disclosed, or represents that its use would not infringe any privately owned rights. Reference herein to any specific commercial product, process, or service by trade name, trademark, manufacturer, or otherwise does not constitute or imply its endorsement, recommendation, or favoring by the Government or any agency thereof. The views and opinions of the authors and/or presenters expressed herein do not necessarily state or reflect those of MRI, the DOE, the Government, or any agency thereof.

## Presentation Outline

- What is a plug-in hybrid-electric vehicle (PHEV)?
- Potential petroleum reduction from PHEVs
- Simulation of PHEV efficiency and cost
  - Baseline vehicle assumptions
  - Powertrain technology scenarios
  - Components models (cost, mass, efficiency)
- Results
  - Component sizing
  - Fuel Economy
  - Incremental cost
  - Payback scenarios
- Conclusions & Next Steps

3



## A Plug-In Hybrid-Electric Vehicle (PHEV)

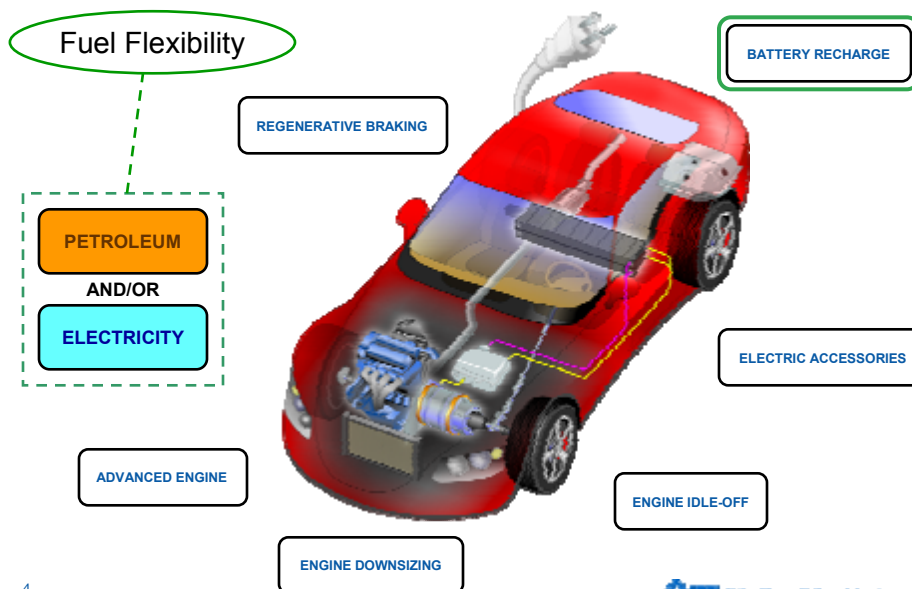

4



## Some PHEV Definitions

**All-Electric Range (AER):** After a full recharge, the total miles driven electrically (engine-off) before the engine turns on for the first time.

**Blended Mode:** A *charge-depleting* operating mode in which the engine is used to supplement battery/motor power.

**PHEV20:** A PHEV with useable energy storage equivalent to 20 miles of driving energy on a reference driving cycle.

**NOTE:** PHEV20 does not imply that the vehicle will achieve 20 miles of AER on the reference cycle nor any other driving cycle. Operating characteristics depend on the power ratings of components, the powertrain control strategy and the nature of the driving cycle

5



## PHEV Key Benefits and Challenges

### KEY BENEFITS



Consumer:

- Lower "fuel" costs
- Fewer fill-ups
- Home recharging convenience
- Fuel flexibility



Nation:

- Less petroleum use
- Less greenhouse and regulated emissions
- Energy diversity/security

### KEY CHALLENGES

- Recharging locations
- Battery life ?
- Component packaging
- Vehicle cost

*Cost-Benefit Analysis*

6



## National Driving Statistics: 1995 National Personal Transportation Survey

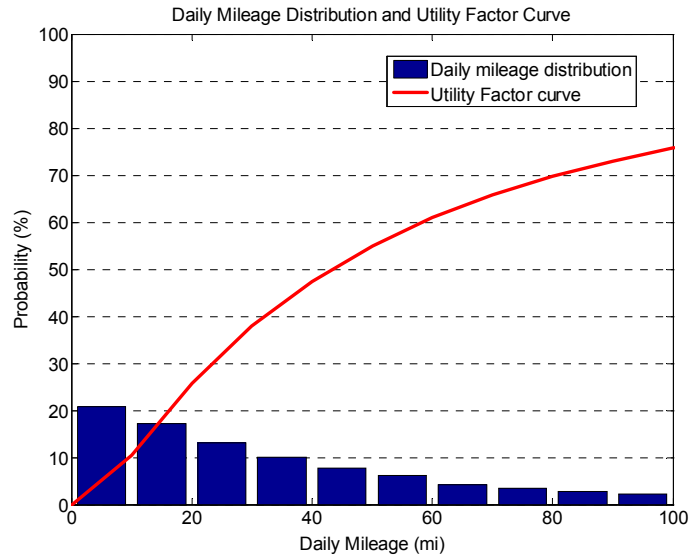

7



## Potential Petroleum Reduction from PHEVs

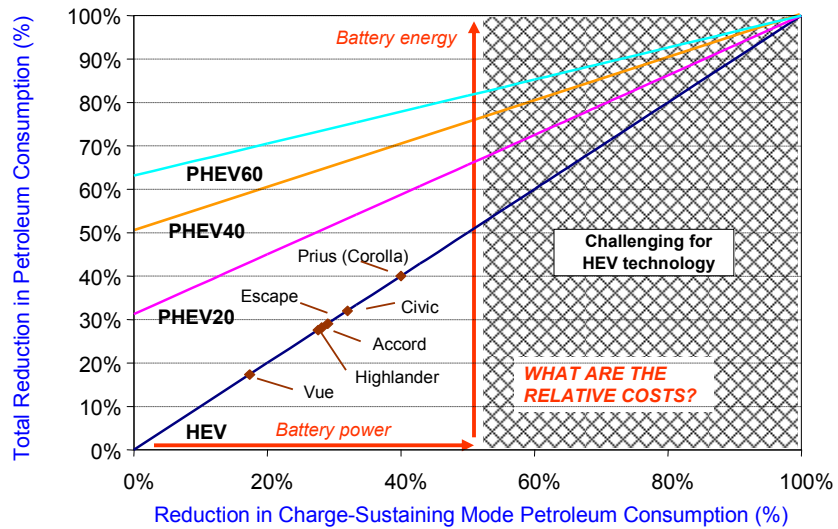

8



## PHEV Efficiency and Cost Model

### Vehicle Configurations

- conventional automatic
- pre-transmission parallel hybrid: HEV or PHEV
- 2 technology scenarios
  - near term and long term

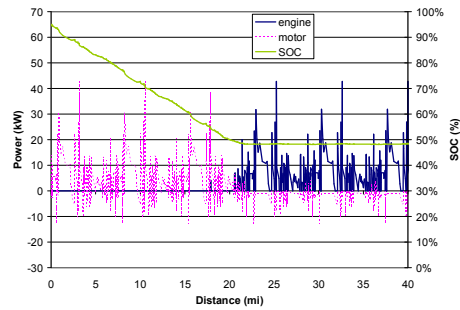

### Approach

- Dynamic, power-flow simulation
- Calculates component sizes and costs
- Iterative mass-compounding
- Measures fuel/electricity consumption using NREL-proposed revisions to SAE J1711
- *Battery definition is key input to the simulation*

9



## Baseline Vehicle Characteristics – Midsize Sedan

MIDSIZE SEDAN (AUTOMATIC)	
<b>Platform Parameters</b>	
Glider Mass	905 kg
Curb Mass	1429 kg
Test Mass	1565 kg (136 kg load)
Gross Vehicle Mass (GVM)	1899 (470 kg load)
Drag coefficient	0.30
Frontal area	2.27m <sup>2</sup>
Rolling resistance coefficient	0.009
Baseline accessory load	800 W elec. + 2900 W A/C
<b>Performance Parameters</b>	
Standing acceleration	0-60 mph in 8.0 s
Passing acceleration	40-60 mph in 5.3 s
Top speed	110 mph
Gradeability	6.5% at 55 mph at GVM with 2/3 fuel converter power
<b>Vehicle attributes</b>	
Engine power	121 kW
Fuel economy	22.2 / 35.2 / 26.6 mpg (urban / highway / composite, unadjusted)



10



# Powertrain Technology Scenarios

Battery	Near-Term Scenario	Long-Term Scenario
Chemistry	NiMH	Li-Ion
Module cost	Double EPRI projections, see slide 12	EPRI projections, see slide 12
Packaging cost	EPRI	Same
Module mass	NiMH battery design function (Delucchi), see slide 12	Li-Ion battery design function (Delucchi), see slide 12
Packaging mass	Delucchi	Same
Efficiency	Scaleable model based on P/E ratio	Same
SOC window	SOC design curve based on JCI data for NiMH cycle-life, see slide 11	Same (assumes Li-Ion achieves same cycle life as NiMH)

Motor	Near-Term Scenario	Long-Term Scenario
Mass	DOE 2006 current status	Based on GM Precept motor drive
Efficiency	95% peak efficiency curve	Same
Cost	EPRI (near term)	EPRI (long term)

Engine	Near-Term Scenario	Long-Term Scenario
Mass	Based on MY2003 production engines	Same*
Efficiency	35% peak efficiency curve	Same*
Cost	EPRI	Same*

\* Engine technologies were not improved so as to isolate the benefits of improved plug-in hybrid technology

11



# Battery Definition as Key Input to Simulation

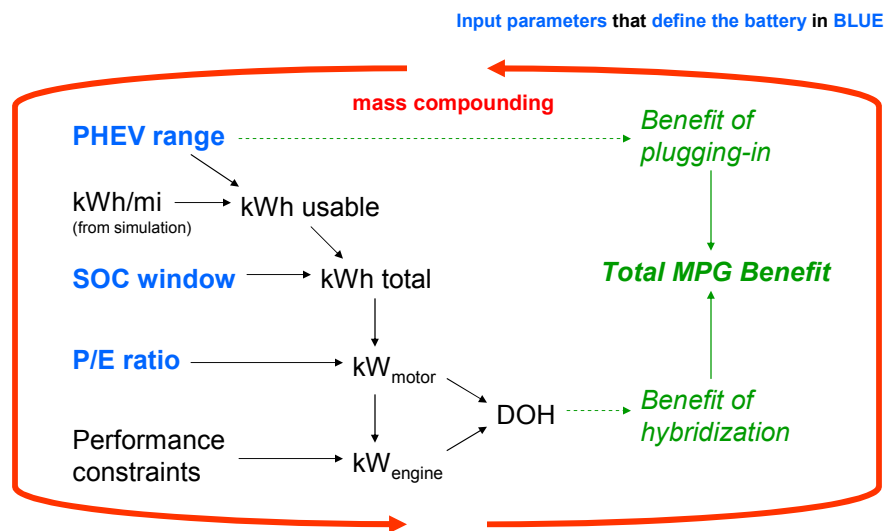

12





## Battery SOC Design Window

Battery SOC design curve for 15 year cycle life

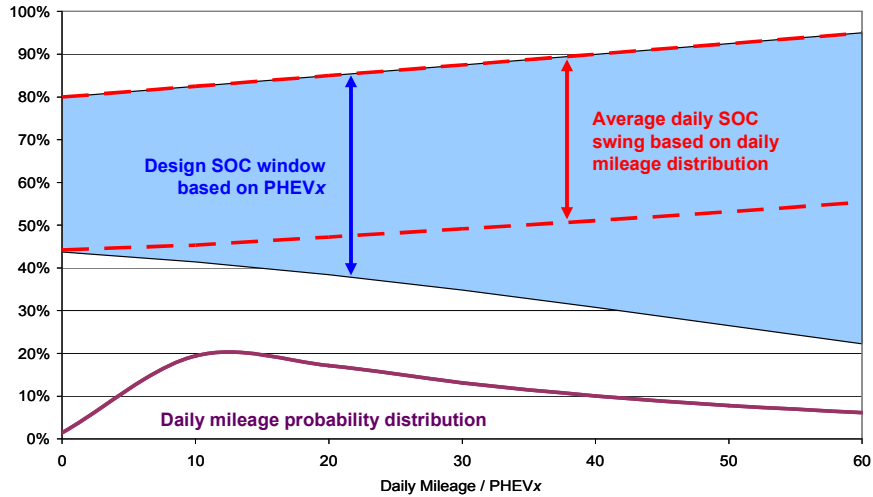

13



## Battery Models (Scaleable)

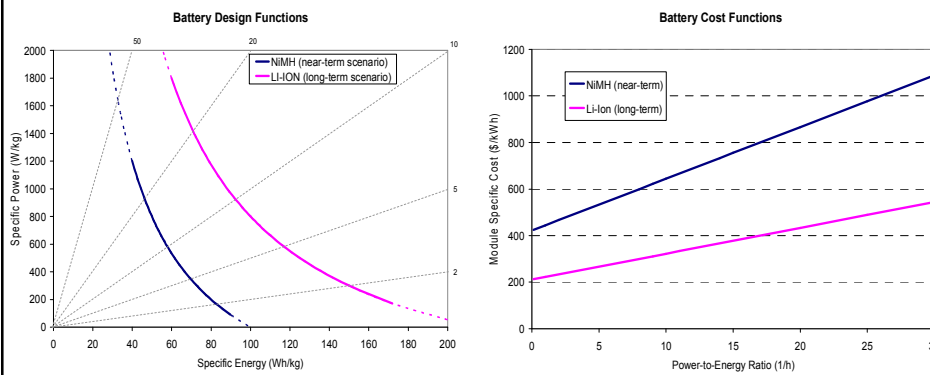

14



## Results: Battery Specifications

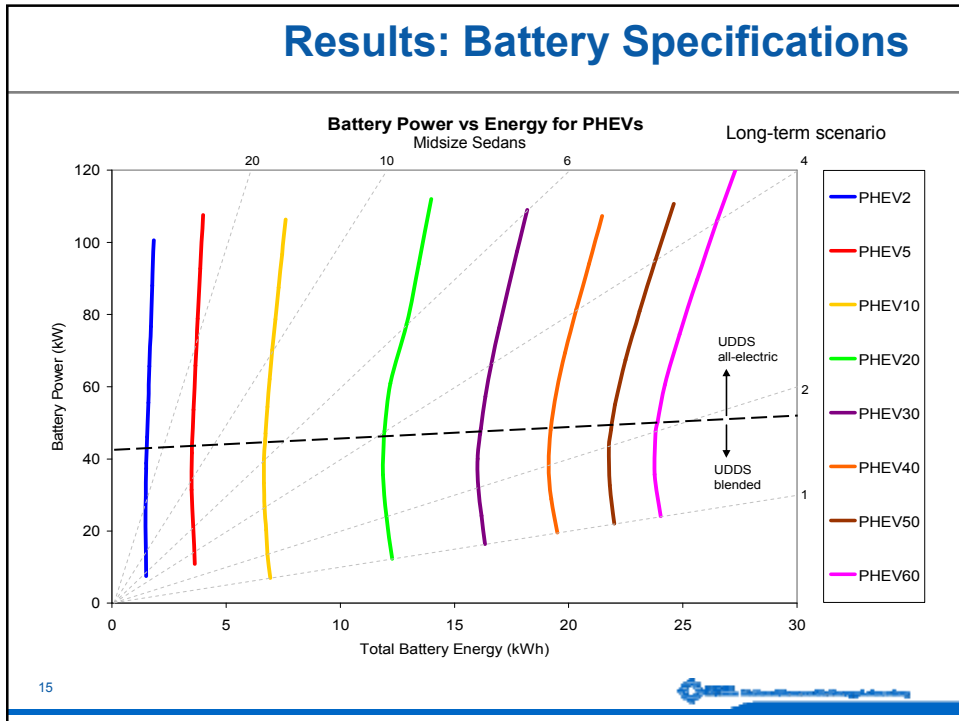

## Results: Battery Specifications

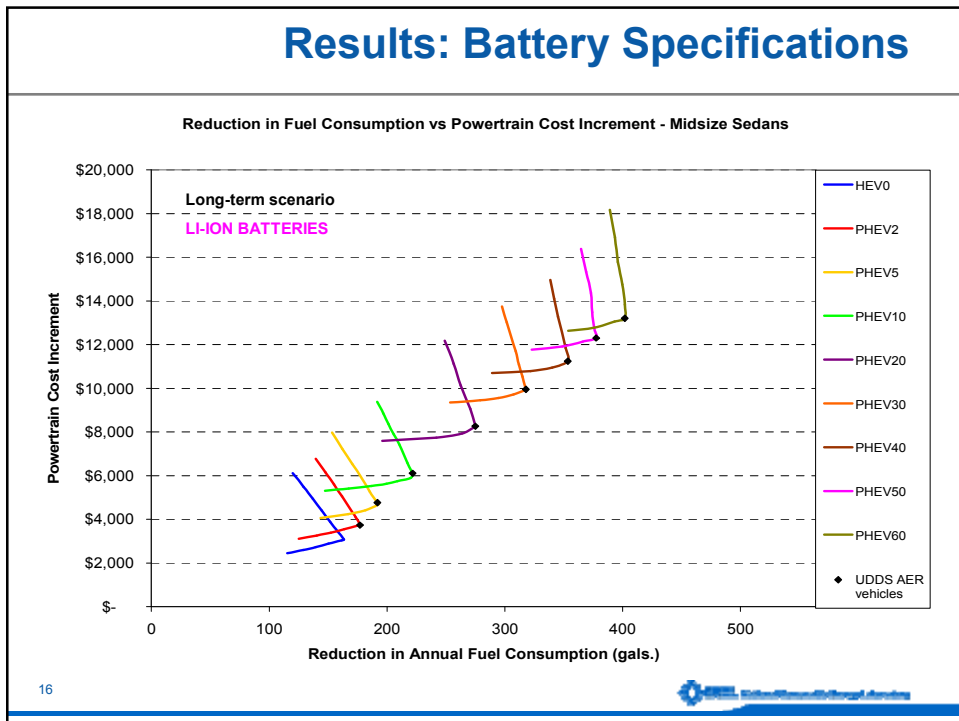

# PHEV Energy Use

PHEV Onboard Energy Use: Near and Long-Term Scenarios

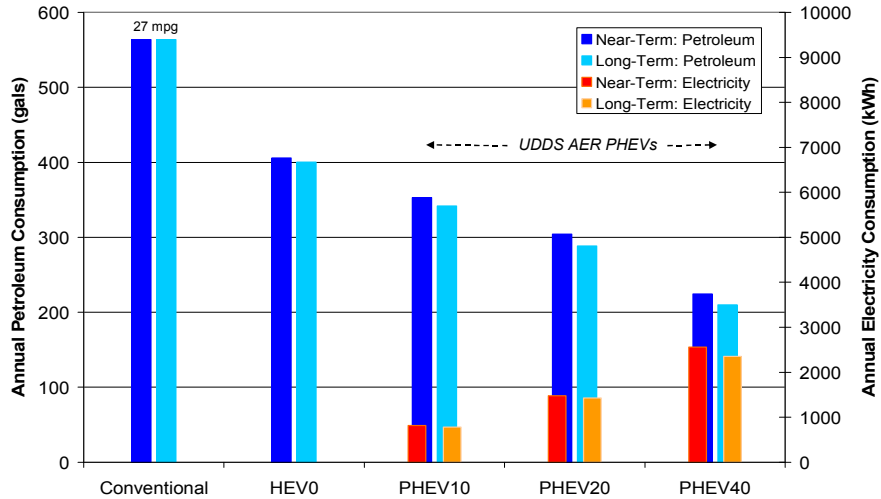

17



# Powertrain Costs Comparison – Near Term

Powertrain Costs (incl. retail markups)

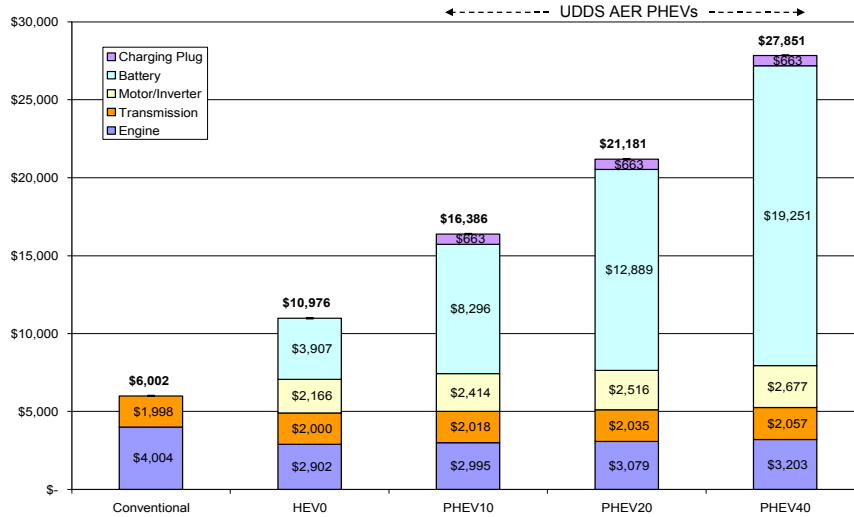

18



## Powertrain Costs Comparison – Long Term

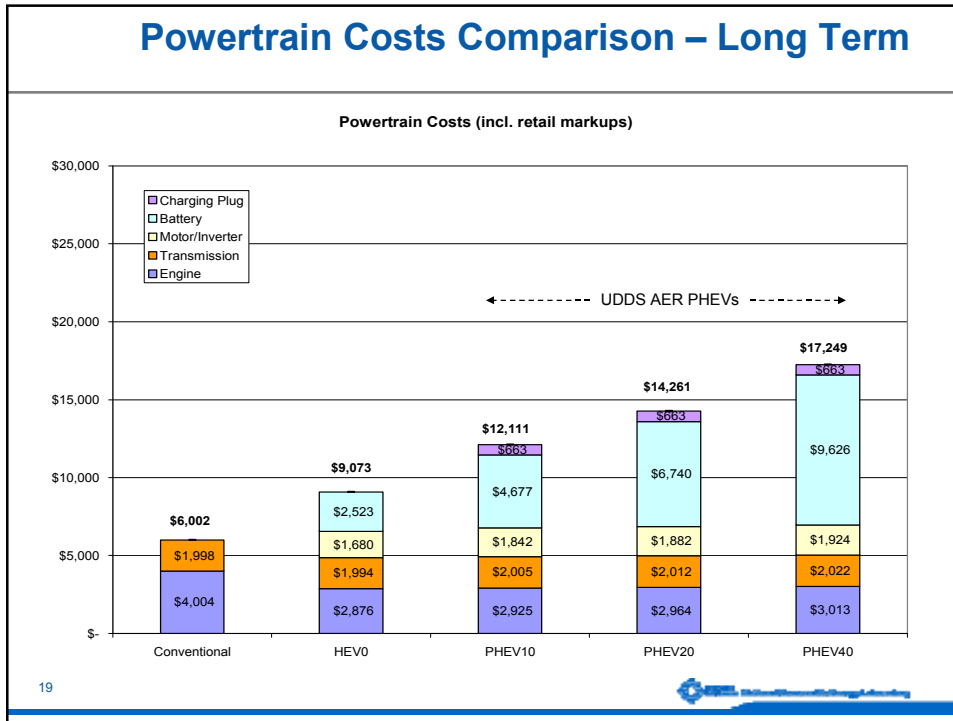

## Overall Cost Comparison for HEVs and PHEVs

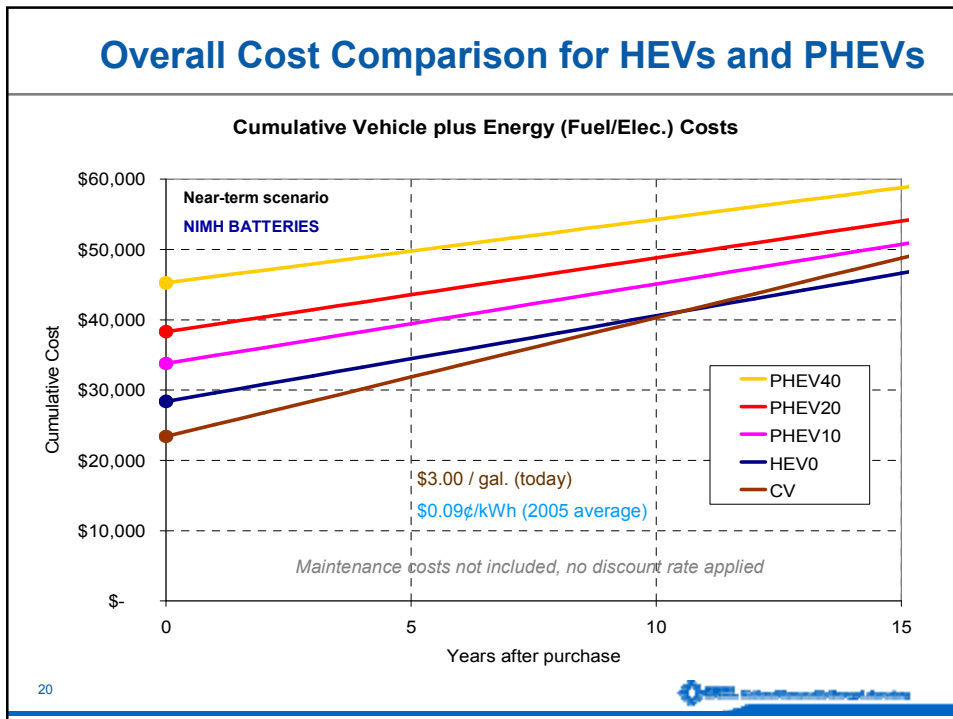

## Overall Cost Comparison for HEVs and PHEVs

Cumulative Vehicle plus Energy (Fuel/Elec.) Costs

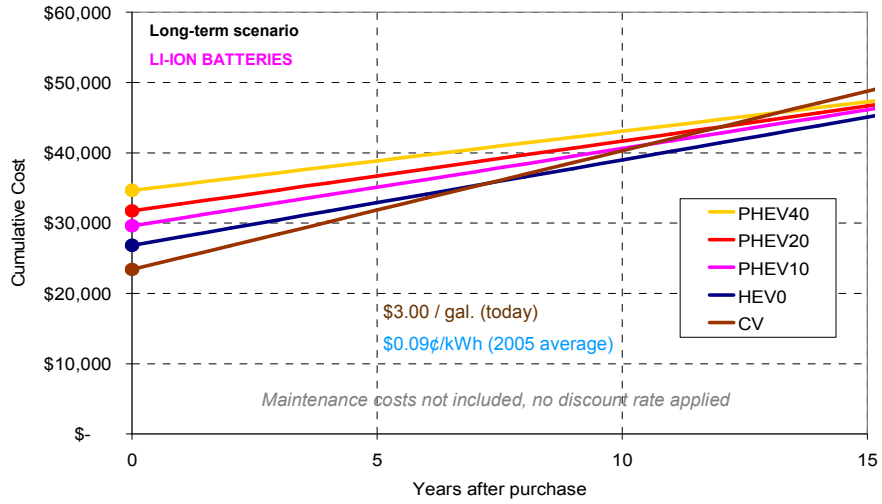

21



## Overall Cost Comparison for HEVs and PHEVs

Cumulative Vehicle plus Energy (Fuel/Elec.) Costs

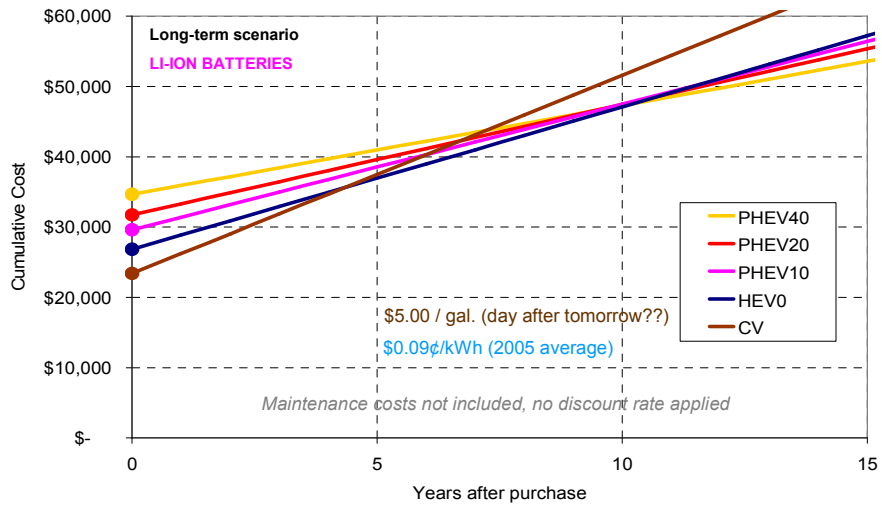

22



## Vehicle Costs cont.

### Why might PHEV buyers pay more?

1. Tax incentives
2. Reduced petroleum use, air pollution and CO<sub>2</sub>
3. National energy security
4. Less maintenance
5. Reduced fill-ups
6. Convenience of home recharging (off-peak)
7. Improved acceleration (high torque of electric motors)
8. Green image, “feel-good factor”
9. Backup power
10. Vehicle-to-grid (V2G)

23



## Conclusions

1. There is a very broad spectrum of HEV-PHEV designs.
2. **Key factors** in the HEV/PHEV cost-benefit equation include:
  - **Battery costs**
  - **Fuel costs**
  - **Control strategy** (particularly battery SOC window)
  - **Driving habits** (annual VMT and trip-length distribution)
3. Based on the assumptions of this study:
  - HEVs can reduce per-vehicle fuel use by approx. 30%.
  - PHEVs can **reduce per-vehicle fuel use by up to 50% for PHEV20s and 65% for PHEV40s.**
  - In the long term, powertrain cost increments are predicted to be **\$2-6k for HEVs, \$7-11k for PHEV20s and \$11-15k for PHEV40s** assuming that projected component (battery) costs can be achieved.
  - Note this study did not consider benefits from platform engineering (i.e. mass/drag reduction).

24



## Conclusions (cont.)

4. Based on overall costs (powertrain plus energy):
  - At today's fuel and powertrain component costs, conventional vehicles are the most cost-competitive.
  - HEVs become the most cost-competitive EITHER if fuel prices increase OR projected battery costs are achieved.
  - PHEVs become cost-competitive ONLY if projected battery costs are achieved AND fuel prices increase.
  - Tax incentives and/or alternative business models (e.g. battery lease) may be required for successful marketing of PHEVs

25



## Next Steps

- Present this work at EVS22
  - Expand the HEV-PHEV analysis space to include:
    - Platform engineering (mass/drag reduction)
    - Different performance constraints / component sizes

SAE 2007 paper
  - Detailed simulation of promising PHEV designs:
    - Real world driving patterns (e.g. St Louis data)
    - Control strategy optimization

TRB 2007 paper
  - Optimization of PHEV market competitiveness using Technical Targets Tool
- Ongoing analysis

26



# Section 3

## **Plug-In Hybrid Electric Vehicle Real-World Performance Expectations**

The consumption of electricity and petroleum by a PHEV will be strongly influenced by the daily distance traveled between recharge events and the aggressiveness of driving. Rather than rely on standard test profiles for a prediction of PHEV fuel consumption, we have collaborated with municipalities to use existing drive cycle databases as inputs to our simulation models. The simulation results provide key insights into consumer travel behavior and quantify the real-world potential for PHEVs to displace petroleum. The first data set was from the St. Louis, Missouri, metropolitan area and includes 227 unique driving profiles, with daily travel distances ranging from less than a mile to more than 270 miles.

Conclusions from the travel survey data are:

- Approximately 50% of the vehicles traveled less than 29 miles a day. A PHEV with 20–30 miles of electric range capability provides sufficient energy to displace a large percentage of daily petroleum consumption. Because many vehicles drive less than 30 miles a day, the battery of a PHEV with 30 or more miles of electric range capability would likely be under-utilized on a daily basis.
- The travel survey data demonstrated that there is a broad spectrum of driving behavior, varying from short to long distances and from mild to aggressive driving intensities. The Urban Dynamometer Driving Schedule and Highway Fuel Economy Test driving profiles used for fuel economy reporting today fall short of capturing the typical driving behavior of today’s consumer.
- Contrary to experience with hybrid electric vehicles, which typically deliver fuel economies significantly less than their rated values, simulations of real-world driving suggest that a large percentage of drivers of PHEVs will likely observe fuel economies in excess of the rated fuel economy values. However, because of high power requirements in real-world cycles, drivers are unlikely to experience significant all-electric operation if PHEVs are designed for all-electric range on the Urban Dynamometer Driving Schedule.
- If all vehicles in the travel survey “fleet” were PHEV20 vehicles designed for all-electric range on the Urban Dynamometer Driving Schedule, petroleum consumption would be reduced by 56% relative to a conventional vehicle fleet. The PHEV40 reduced consumption by an additional 12% and was equivalent to  $\approx 1$  gal/vehicle/day of petroleum savings. Including electricity costs, the average annual fuel costs savings for the “fleet” of PHEVs is more than \$500/vehicle/year.
- The time-of-day usage pattern obtained from global positioning system (GPS) travel survey data and the recharge requirements from simulation will be extremely valuable for determining the impact of PHEV recharging scenarios on the electric utility grid.

Since the St. Louis analyses were completed, data from five other metropolitan GPS travel surveys have been obtained. The driving profile database will expand from 227 to more than 2,000 vehicles. Additional analyses will be completed using the full collection of more than 2,000 driving profiles. Real-world travel simulations will be executed to consider variations in platform, aerodynamics, performance, control, and recharge scenarios. In addition, the database will be used to explore the emissions control implications of potential engine cold-starts and the fuel consumption impacts of location-specific air conditioning use.

For more extensive discussion of this topic, please refer to sections 3.1, 3.2, and 3.3.



# Section 3.1

**Title:** “Plug-In Hybrid Electric Vehicles: Current Status, Long-Term Prospects, and Key Challenges”

**Type:** Presentation

**Author:** Tony Markel

**Date:** May 8, 2006

**Conference or Meeting:** Clean Cities Congress and Exposition in Phoenix, Arizona

**Abstract:** Discusses what a plug-in hybrid is, its potential benefits, and the key technical challenges to overcome

## **Plug-in Hybrid Electric Vehicles**

### **Current Status, Long-Term Prospects and Key Challenges**

*Presented at Clean Cities Congress and Expo*

by

**Tony Markel**

**National Renewable Energy Laboratory**

May 8<sup>th</sup>, 2006

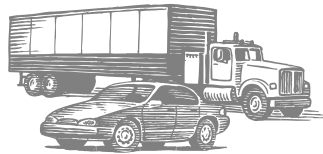

With support from the  
U.S. Department of Energy  
Office of Energy Efficiency and Renewable Energy  
FreedomCAR and Vehicle Technologies Program

Presented at Clean Cities Congress and Expo held May 7-10, 2006 in Phoenix, Arizona  
NREL/PR-540-40239

NREL is operated by Midwest Research Institute • Battelle 

#### **Disclaimer and Government License**

This work has been authored by Midwest Research Institute (MRI) under Contract No. DE-AC36-99GO10337 with the U.S. Department of Energy (the "DOE"). The United States Government (the "Government") retains and the publisher, by accepting the work for publication, acknowledges that the Government retains a non-exclusive, paid-up, irrevocable, worldwide license to publish or reproduce the published form of this work or allow others to do so, for Government purposes.

Neither MRI, the DOE, the Government, nor any other agency thereof, nor any of their employees, makes any warranty, express or implied, or assumes any liability or responsibility for the accuracy, completeness, or usefulness of any information, apparatus, product, or process disclosed, or represents that its use would not infringe any privately owned rights. Reference herein to any specific commercial product, process, or service by trade name, trademark, manufacturer, or otherwise does not constitute or imply its endorsement, recommendation, or favoring by the Government or any agency thereof. The views and opinions of the authors and/or presenters expressed herein do not necessarily state or reflect those of MRI, the DOE, the Government, or any agency thereof.

## The Perfect Storm

- Petroleum **consumption** has steadily **increased** while domestic **production** has continued to **decline**
- World oil **production** predicted to **peak** within the next 5-15 years
- Recent increase in **gasoline price** is indicator of **growing tension** between supply and demand

Gasoline price - 85% rise in 5 years!

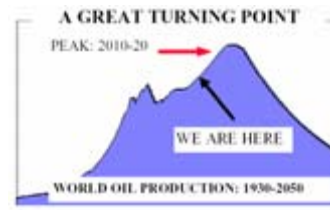
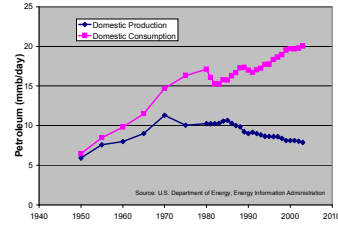
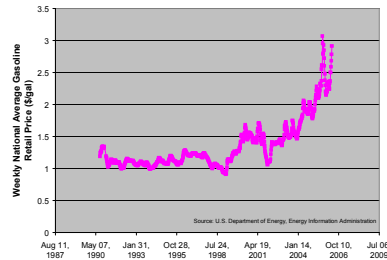

WHAT'S OUR PLAN?

3

## A "Full" Hybrid

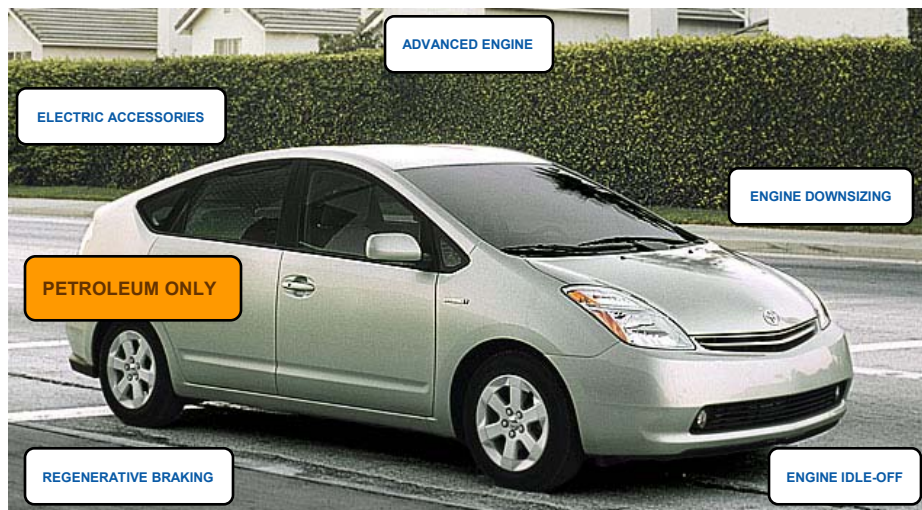

76hp gasoline engine, 67hp electric motor, 1.5kWh battery

4

# A Plug-In Hybrid

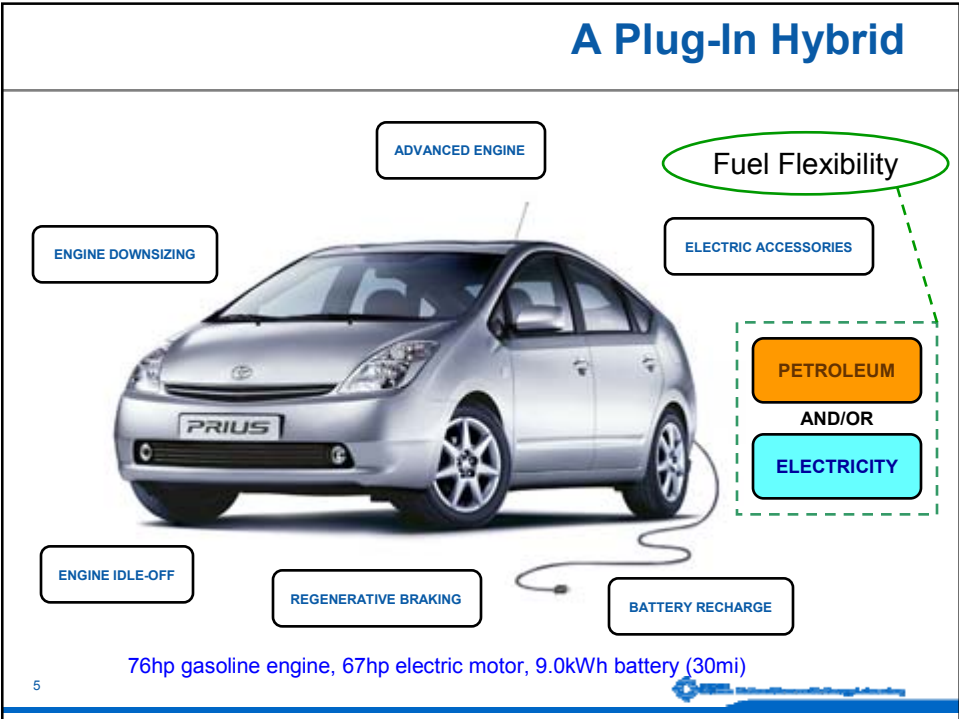

5

# Oil Use Reduction with HEVs

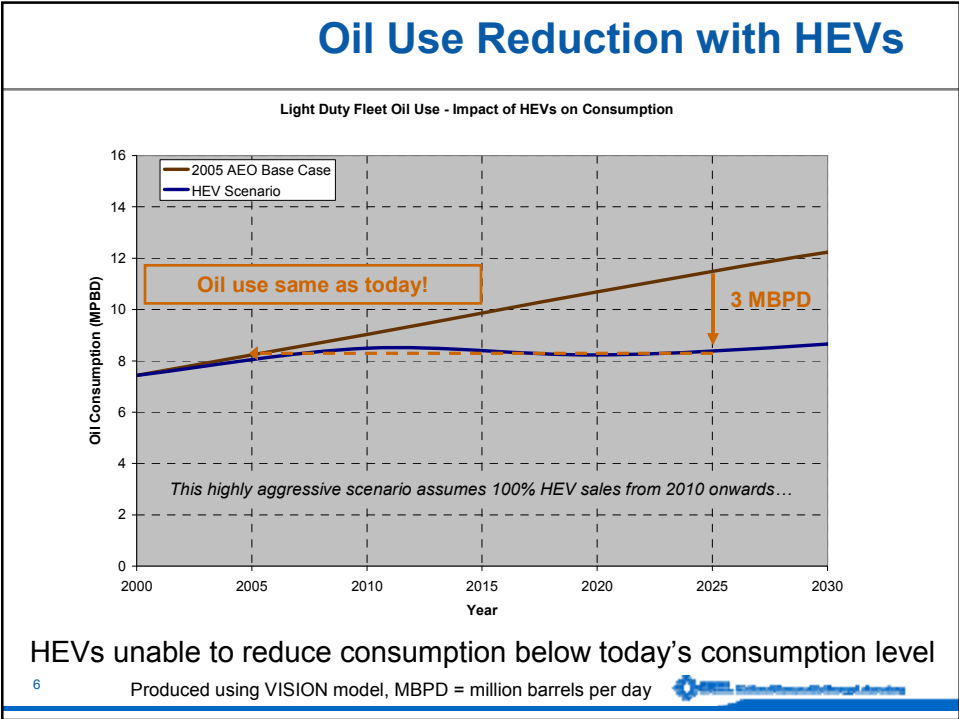

## Oil Use Reduction with PHEVs

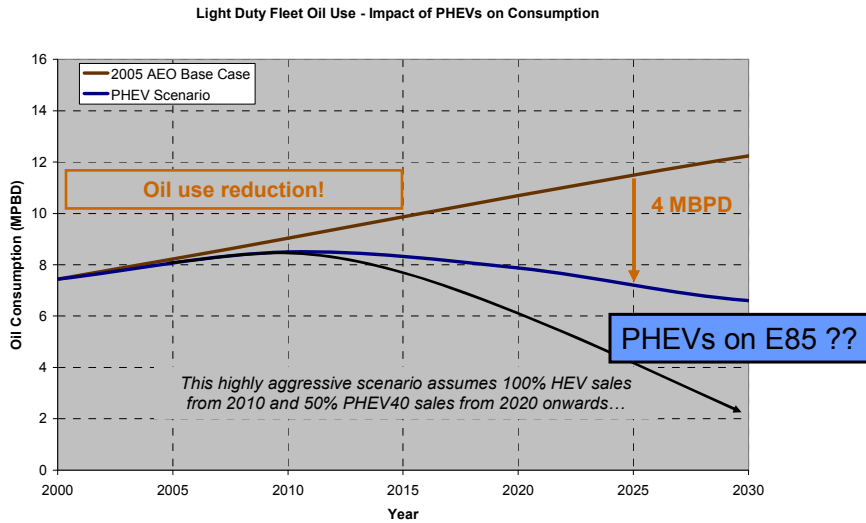

PHEVs reduce oil consumption with a transition to electricity

7

Produced using VISION model, MBPD = million barrels per day



## OEM Plug-In Hybrids



### 2003 Renault Kangoo Elect'road

- up to 50mi electric range
- approximately 500 sold in Europe



### DaimlerChrysler Sprinter PHEV

- 15 prototypes being produced for testing in various locations in Europe and North America
- up to 20mi electric range

8



## Other PHEV Prototypes - Industry



EnergyCS Plug-In Prius



HyMotion Escape PHEV



AFS Trinity Extreme Hybrid™



AC Propulsion Jetta PHEV



Esoro AG H301

9



## Design Options All-Electric vs Blended Strategy

### All-Electric

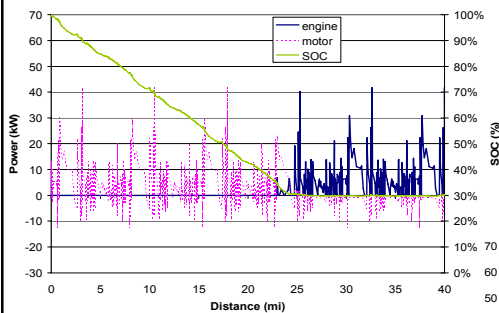

- Engine turns on when battery reaches low state of charge
- Requires high power battery and motor

- Engine turns on when power exceeds battery power capability
- Engine only provides load that exceeds battery power capability

### Blended

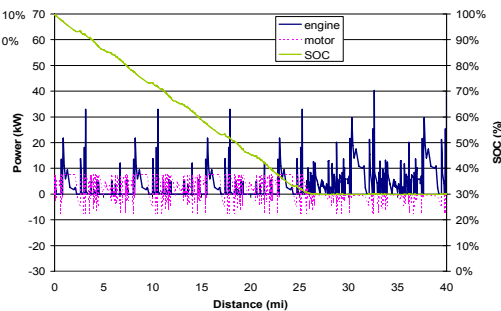

10



## Household Travel Survey Data Can be Used to Predict Real-World Benefits of Advanced Technologies

- Provides valuable insight into travel behavior
- GPS augmented surveys supply details needed for vehicle simulation

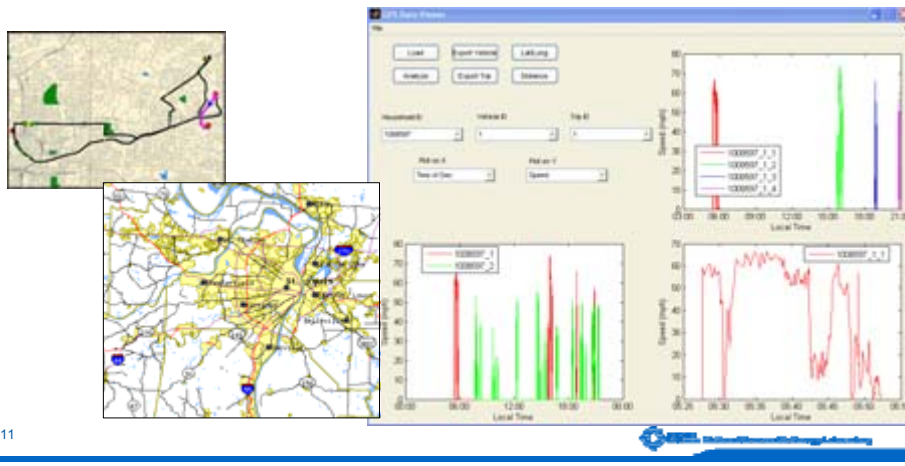

11

## PHEVs Reduce Fuel Consumption By 50% On Real-World Driving Cycles

227 vehicles from St. Louis each modeled as a conventional, hybrid and PHEV

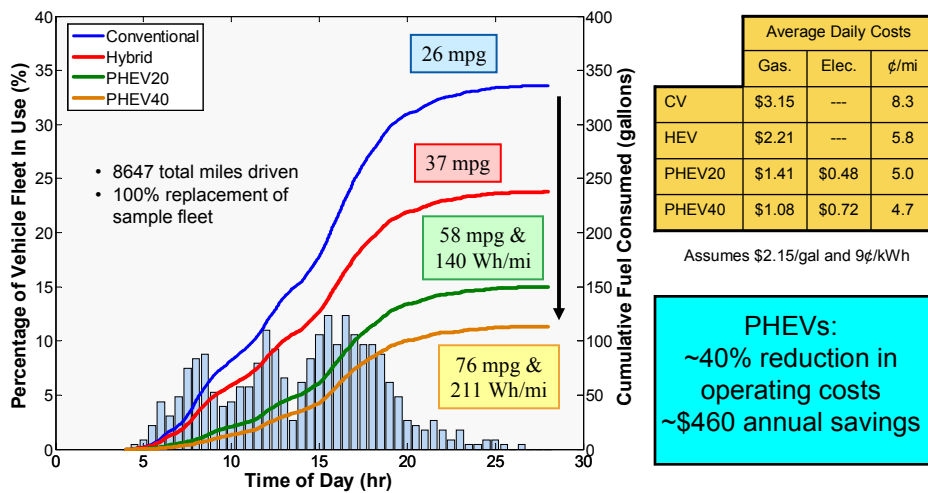

12

## HEVs and PHEVs Likely to Reduce Greenhouse Emissions

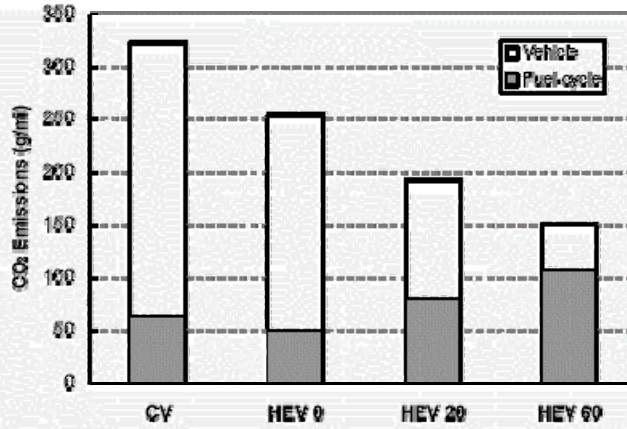
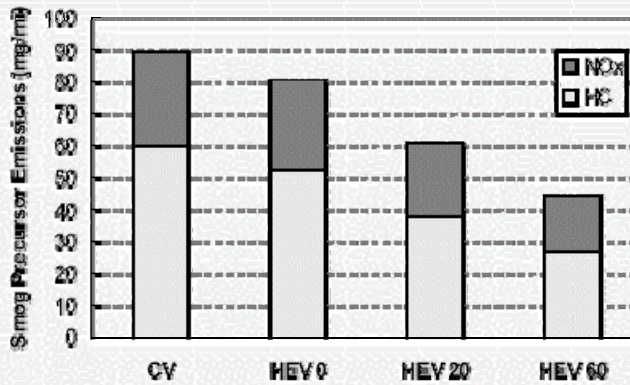

**Figure 2-10**  
Greenhouse Gas Emissions (CO<sub>2</sub>) "Well-to-Wheels" for the Compact Car for the Average Driving Schedule and Charging Nightly

13 Source: Hybrid Electric Vehicle Working Group, [www.epri.com](http://www.epri.com)



## Electrified Miles May Lead to Cleaner Operation



**Figure 2-7**  
NO<sub>x</sub> Plus HC (Smog) "Well-to-Wheels" Emissions for the Compact Car for the Average Driving Schedule and Charging Nightly

14 Source: Hybrid Electric Vehicle Working Group, [www.epri.com](http://www.epri.com)





## In-Use Simulations Show Reasonable Recharge Times with Standard Household Outlet

- Typical vehicle is used less than 5% of the time
  - Lots of opportunity for recharging
- Both PHEV20 and PHEV40 owners likely to get full recharge overnight with standard outlet

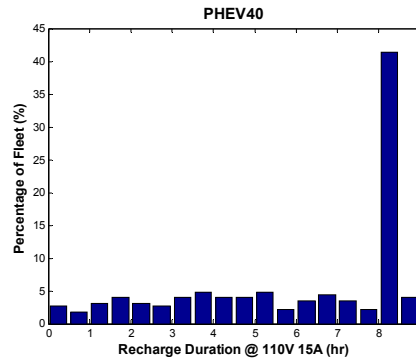
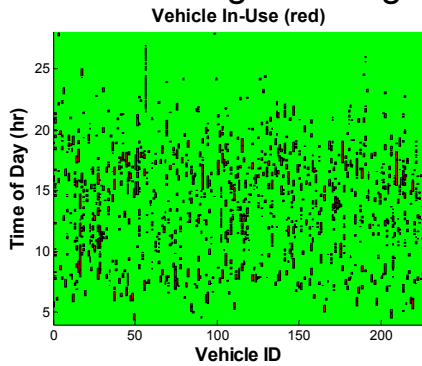

15

## Technical Challenges Battery Life

- PHEV battery likely to deep-cycle each day driven: 15 yrs equates to 4000-5000 deep cycles
- Also need to consider combination of high and low frequency cycling

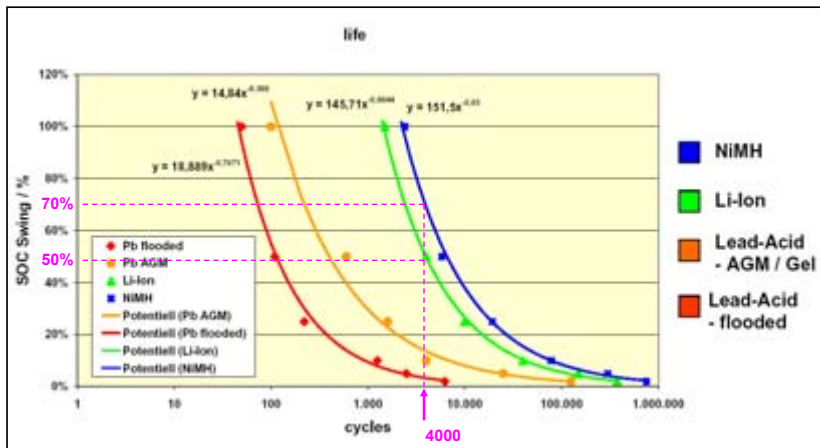

Data presented by Christian Rosenkranz (Johnson Controls) at EVS 20

16

## Technical Challenges Battery Packaging



17



## Technical Challenges Vehicle Costs

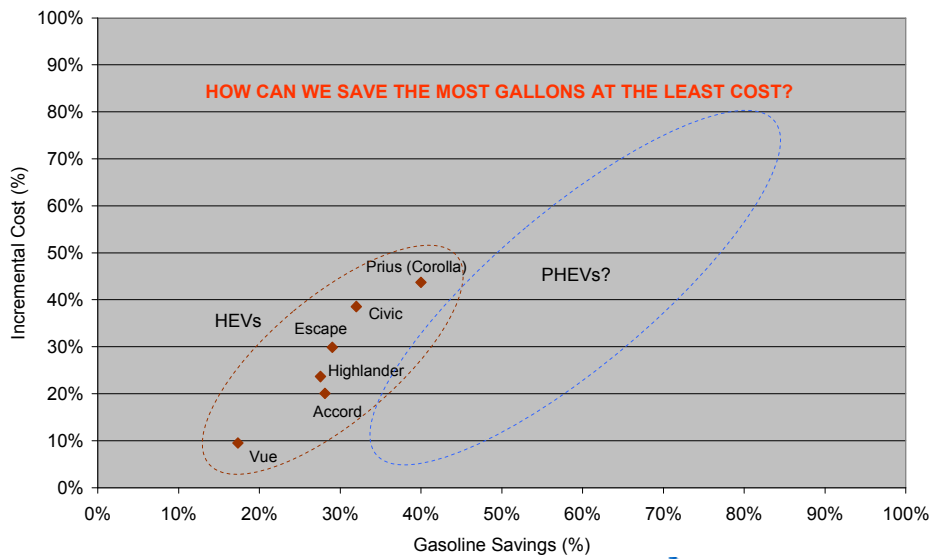

18



## Conclusions

- Plug-in hybrid technology uses electricity from the utility grid to reduce petroleum consumption beyond that of HEV technology
  - Predicted 50% reduction in in-use consumption based on simulations using travel survey data
- Industry interest is growing and some prototypes have been built
  - Collaboration between labs and industry will likely lead to innovative systems solutions
- The U.S. Department of Energy is expanding its research portfolio to include PHEVs
  - Research will address key remaining barriers to commercial PHEVs including battery life, packaging, and cost

## Section 3.2

**Title:** “Plug-In Hybrid Vehicle Real-World Performance Expectations”

**Type:** Presentation

**Author:** Tony Markel

**Date:** June 14, 2006

**Conference or Meeting:** Presented to the Vehicle Systems Analysis Technical Team

**Abstract:** Summarizes the simulated performance of optimal PHEVs on a collection of real-world driving profiles from the St. Louis, Missouri, metropolitan area

# Plug-in Hybrid Vehicle Real-world Performance Expectations

a presentation to FreedomCAR Vehicle Systems Analysis Tech Team  
by  
**Tony Markel**  
National Renewable Energy Laboratory

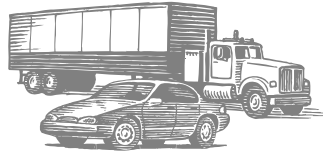

June 14, 2006

With support from the  
U.S. Department of Energy  
Office of Energy Efficiency and Renewable Energy  
FreedomCAR and Vehicle Technologies Program

## Disclaimer and Government License

This work has been authored by Midwest Research Institute (MRI) under Contract No. DE-AC36-99GO10337 with the U.S. Department of Energy (the "DOE"). The United States Government (the "Government") retains and the publisher, by accepting the work for publication, acknowledges that the Government retains a non-exclusive, paid-up, irrevocable, worldwide license to publish or reproduce the published form of this work or allow others to do so, for Government purposes.

Neither MRI, the DOE, the Government, nor any other agency thereof, nor any of their employees, makes any warranty, express or implied, or assumes any liability or responsibility for the accuracy, completeness, or usefulness of any information, apparatus, product, or process disclosed, or represents that its use would not infringe any privately owned rights. Reference herein to any specific commercial product, process, or service by trade name, trademark, manufacturer, or otherwise does not constitute or imply its endorsement, recommendation, or favoring by the Government or any agency thereof. The views and opinions of the authors and/or presenters expressed herein do not necessarily state or reflect those of MRI, the DOE, the Government, or any agency thereof.

## Outline

- Objective
- Approach
- Assumptions
- Travel survey data
- Simulated in-use operation
- Conclusions
- Next steps

3



## Objective and Justification

- Extend preliminary PHEV analyses to predict consumption and performance of vehicles in real-world applications
- Fuel consumption benefits and operation of PHEVs are highly dependent on usage pattern
  - What are real usage patterns like?
  - How do rated versus in-use fuel consumption and all electric range compare?

4



## Approach

- Consider PHEV20 and PHEV40 architectures
  - Based on Presidential initiatives and recent cost/benefit analysis
  - Component sizing and energy management strategy to provide all electric operation on urban profile
- Generate a collection of real-world driving profiles from St. Louis, Missouri metropolitan household travel survey data
  - Sample data from GPS units in support of larger written survey
- Optimize vehicle energy management strategy parameters
  - Vary electric launch speeds at high and low SOC set points and charge torque
  - Minimize fuel consumption on UDDS, US06, HWFET, SC03
  - Minimize the number of engine start/stop events
- Complete detailed cycle simulation
  - Use existing PHEV, HEV, and Conventional architecture models
  - 24 hour driving profiles
    - » ~10 minutes per profile \* 227 profiles = 38 hours (for one architecture)
  - Include 4 architectures (Conventional, HEV, PHEV20, PHEV40)
- Summarize simulation results

5



## Baseline Vehicle Characteristics

MIDSIZE SEDAN (AUTOMATIC) – MSRP \$23,400	
<b>Platform Parameters</b>	
Glider Mass	905 kg
Curb Mass	1429 kg
Test Mass	1565 kg (136 kg load)
Gross Vehicle Mass (GVM)	1899 (470 kg load)
Drag coefficient	0.30
Frontal area	2.27m <sup>2</sup>
Rolling resistance coefficient	0.009
Accessory load	700 W elec. or 823 W mech.
<b>Performance Parameters</b>	
Standing acceleration	0-60 mph in 8.0 s
Passing acceleration	40-60 mph in 5.3 s
Top speed	110 mph
Gradeability	6.5% at 55 mph at GVM with 2/3 fuel converter power
<b>Vehicle attributes</b>	
Engine power	121 kW
Fuel economy	<b>22.2 / 35.2 / 26.6 mpg</b> (urban / highway / composite, unadjusted)



6



## PHEV20 and PHEV40 Characteristics

Attribute	Units	PHEV20	PHEV40	Conventional	HEV
Curb Mass	kg	1488	1567	1429	1399
Battery Power	kW	47.0	51.8	n/a	50
Battery Energy	kWh	9.4	18.5	n/a	1.9
Battery Power to Energy Ratio	--	5	2.8	n/a	26.3
Motor Power	kW	43.6	48.0	n/a	39
Engine Power	kW	79.4	81.9	121.7	82
DOH	%	35.4	37.0	n/a	32.2

- Additional assumptions
  - 70% usable SOC window (stretch goal)
  - Lithium ion technology

## Household Travel Survey Data

- Provides valuable insight into travel behavior
- GPS augmented surveys supply details needed for vehicle simulation

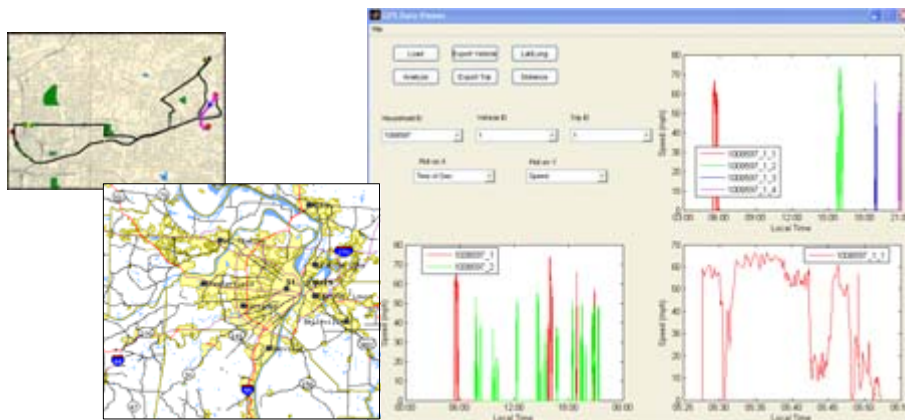

8



## St. Louis Travel Data Analysis

### Daily Driving Distance Similar to 1995 NPTS Data

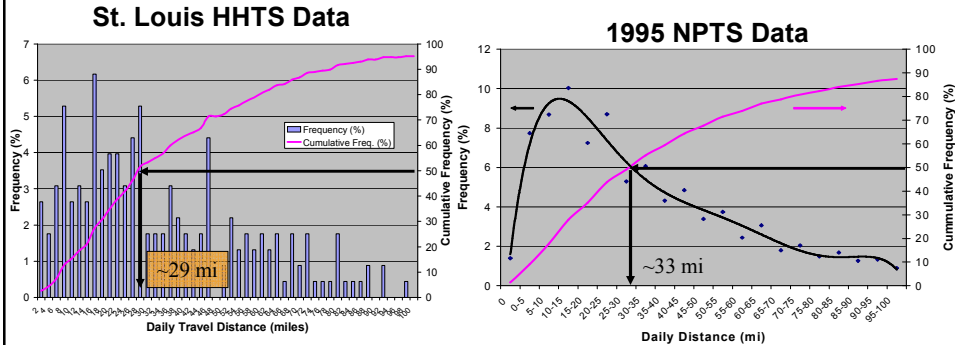

- St. Louis data set includes 227 vehicles from 147 households
- Complete second by second driving profile for one day
- 8650 miles of travel
- St. Louis data set is a small sample of real data
- NPTS data is generated from mileage estimates

9



## In-use PHEV Analysis

- 227 unique driving profiles
- 4 vehicle architectures
  - Conventional, HEV, PHEV20, and PHEV40
- Expectations
  - PHEV20 should displace ~50% of the conventional fleet consumption
  - PHEVs will typically see fuel economy in excess of the rated value
  - There is a correlation between PHEV benefit and daily driving distance
  - All electric range will be less in real driving profiles than on certification cycles

10



## List of Results

- Fleet consumption summary
- Distribution of fuel economy
- Distribution of AER
- Distribution of EV miles
- Distribution of charge depleting miles fraction of total miles
- Distribution of charge sustaining miles fraction of total miles
- Consumption comparison as a function of daily distance

11



## PHEVs Reduce Fuel Consumption By >50% On Real-World Driving Cycles

227 vehicles from St. Louis each modeled as a conventional, hybrid and PHEV

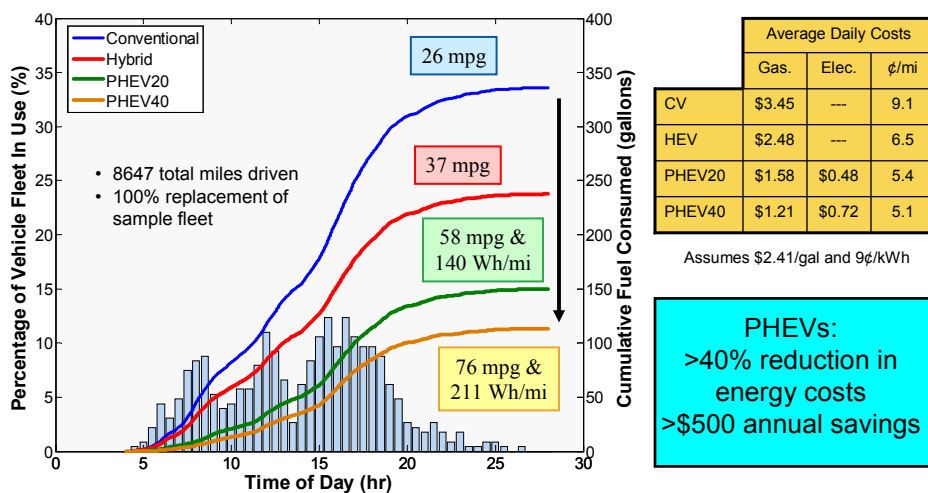

12



## Fuel Economy Distribution - Details

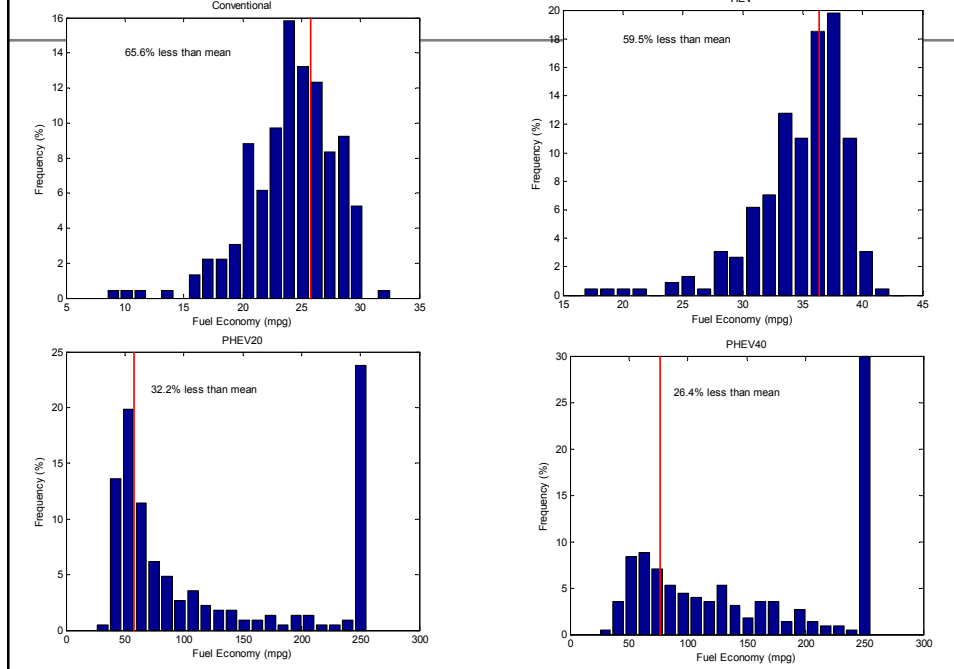

## All Electric Range Distribution

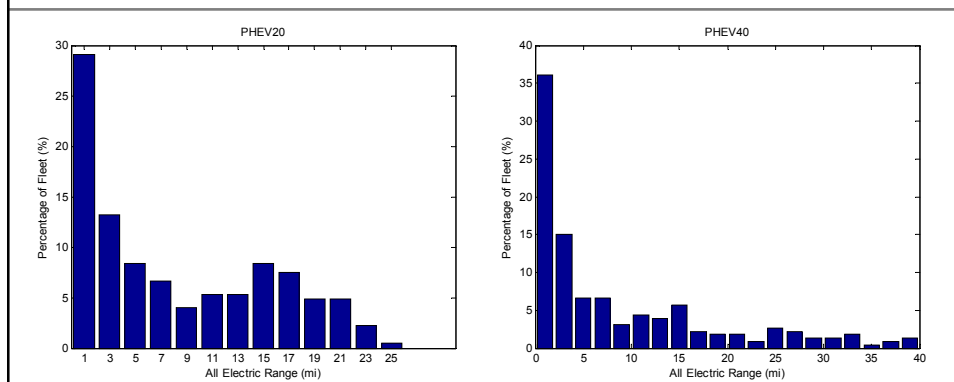

- Vehicles were designed to operate all electrically on UDDS
- Power demands of real profiles exceed UDDS peak power within the first few miles

## Fuel Economy and All Electric Range Comparison

- Difference between rated and median values are significant for the PHEVs
  - Consumers likely to observe fuel economy higher than rated value in typical driving
  - Vehicles designed with all electric range likely to operate in a blended mode to meet driver demands

	<i>Fuel Economy (mpg) **</i>		<i>All Electric Range (mi)</i>	
	<b>Rated</b>	<b>Median</b>	<b>Rated</b>	<b>Median</b>
<b>Conventional</b>	26	24.4	n/a	n/a
<b>HEV</b>	39.2	35.8	n/a	n/a
<b>PHEV20</b>	54	70.2	22.3	5.6
<b>PHEV40</b>	67.4	133.6	35.8	3.8

\*\* Fuel economy values do not include electrical energy consumption

15



## Electric Vehicle Miles Distribution

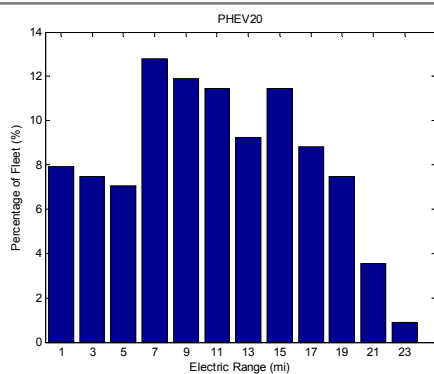

50% of the PHEV20 vehicles had 10 miles or less in EV mode

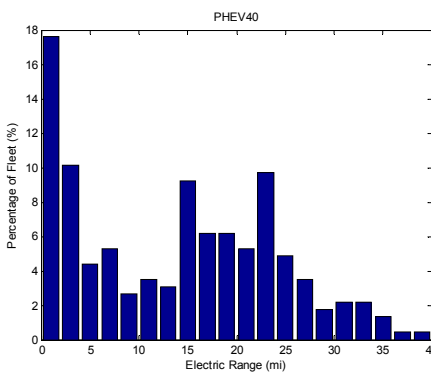

Vehicles operate in a blended mode most of the time

16



# EV Mode Usage

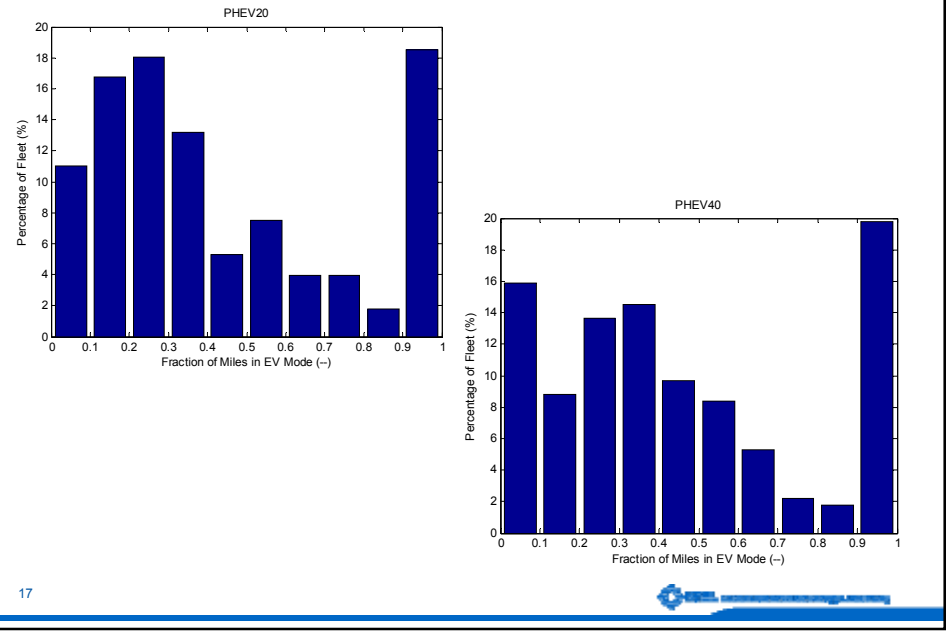

# Charge Depleting vs. Charge Sustaining Mode Operation – PHEV20

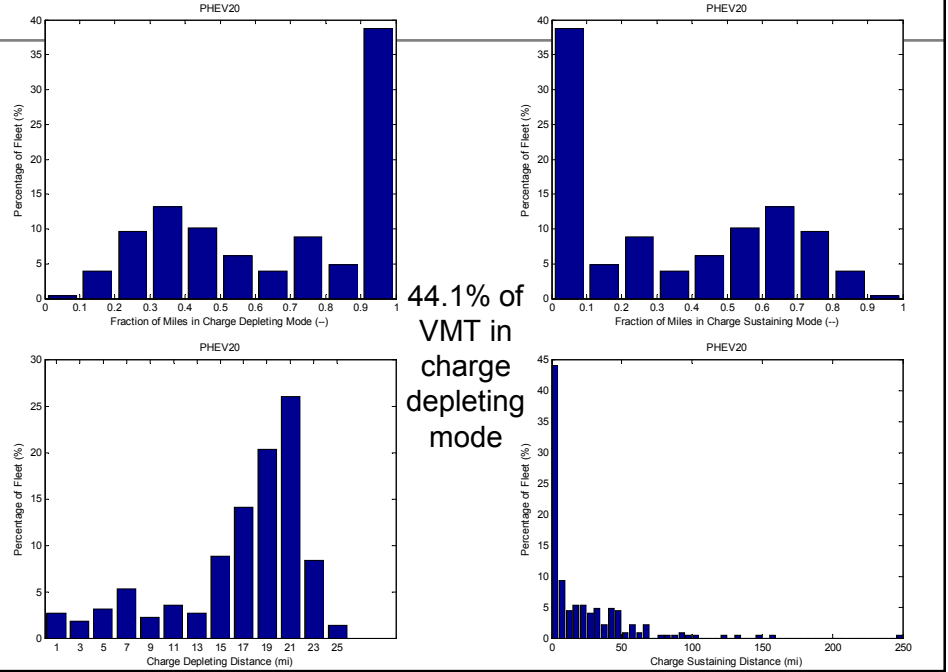

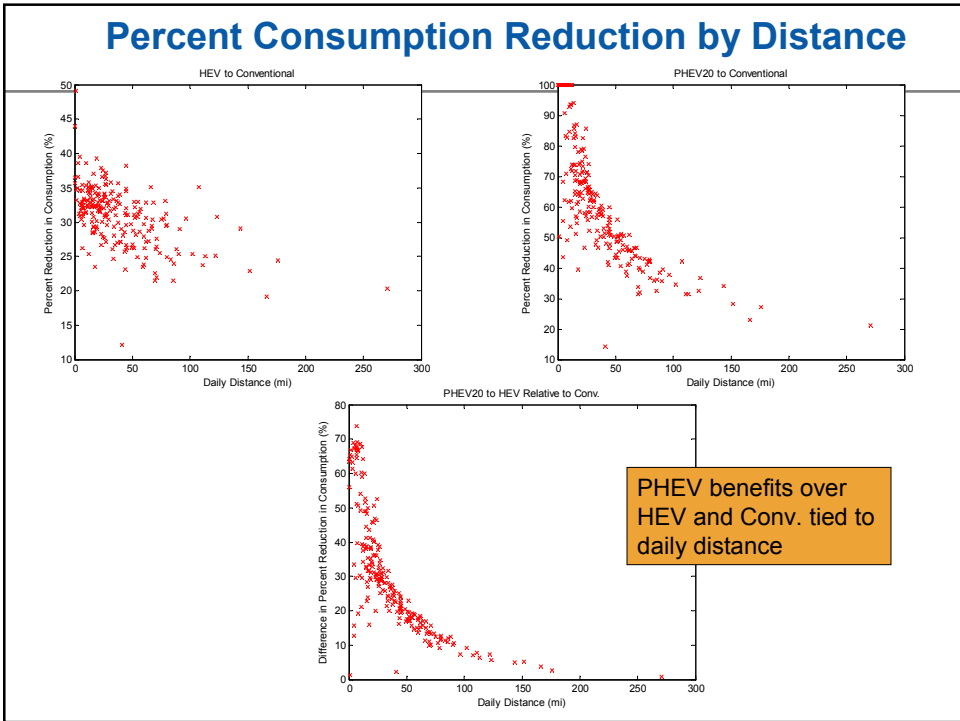
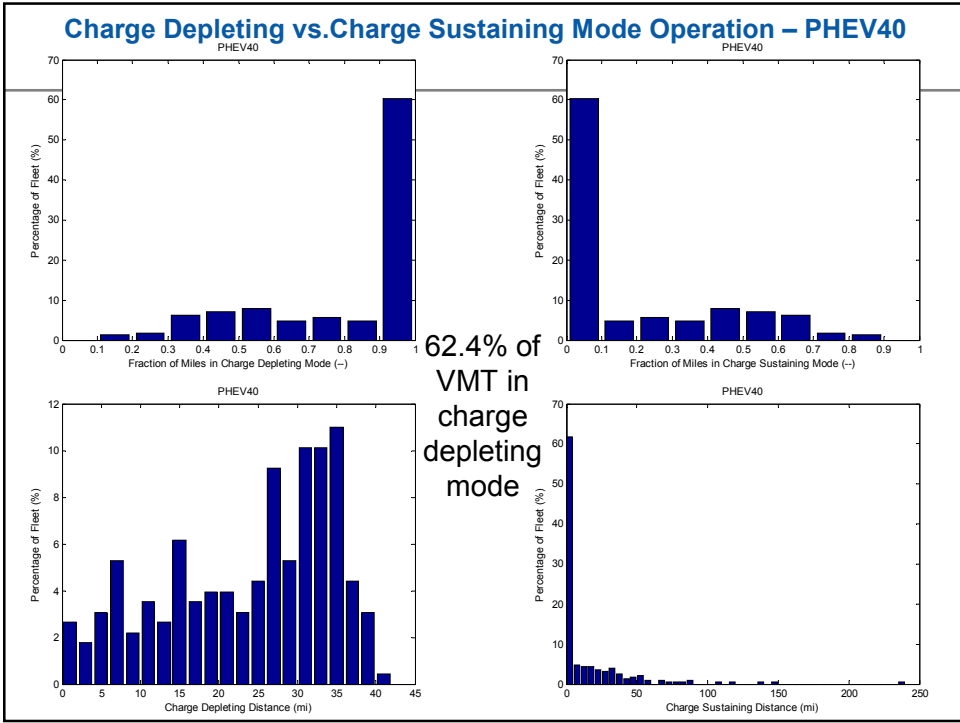

## Conclusions

- Simulations on sample real-world drive cycles suggests PHEV technology can dramatically reduce petroleum consumption
- Benefits of a PHEV over a conventional or HEV are tied to travel behavior
- A vehicle designed for all electric range in urban driving will likely provide only limited electric operation in real world applications
  - Still provides significant fuel displacement

21



## Next Steps

- Repeat analysis for PHEVs designed for blended operation on urban cycle
  - Is the fuel consumption significantly different?
- Expand application of travel survey data
  - Apply statistical expansion factors to represent population
  - Access other metropolitan data sets
- Repeat simulations with alternative recharge scenarios
  - Opportunity recharge
  - Never recharge
- Analyze real world in-use emissions characteristics
  - Daily catalyst temperatures and time of day vehicle emissions

22



## Section 3.3

**Title:** “Using GPS Travel Data to Assess the Real-World Driving Energy Use of Plug-In Hybrid Electric Vehicles”

**Type:** Paper

**Authors:** Jeffrey Gonder, Tony Markel, Andrew Simpson, Matthew Thornton

**Date:** February 2007

**Conference or Meeting:** To be published at the Transportation Research Board 86th Annual Meeting in Washington, D.C.

**Abstract:** Highlights the use of GPS travel survey data for simulating the potential real-world benefits of PHEV technology



# Using GPS Travel Data to Assess the Real World Driving Energy Use of Plug-in Hybrid Electric Vehicles (PHEVs)

TRB 86<sup>th</sup> Annual Meeting, Washington, D.C., 2007

By

Jeffrey Gonder

National Renewable Energy Laboratory (NREL); 1617 Cole Blvd.; Golden, CO 80401  
Phone: 303-275-4462; Fax: 303-275-4415; [jeff\\_gonder@nrel.gov](mailto:jeff_gonder@nrel.gov)

Tony Markel

National Renewable Energy Laboratory (NREL); 1617 Cole Blvd.; Golden, CO 80401  
Phone: 303-275-4478; Fax: 303-275-4415; [tony\\_markel@nrel.gov](mailto:tony_markel@nrel.gov)

Andrew Simpson

National Renewable Energy Laboratory (NREL); 1617 Cole Blvd.; Golden, CO 80401  
Phone: 303-275-4430; Fax: 303-275-4415; [andrew\\_simpson@nrel.gov](mailto:andrew_simpson@nrel.gov)

Matthew Thornton

National Renewable Energy Laboratory (NREL); 1617 Cole Blvd.; Golden, CO 80401  
Phone: 303-275-4273; Fax: 303-275-4415; [matthew\\_thornton@nrel.gov](mailto:matthew_thornton@nrel.gov)

## Word Count

- 4695 words, plus 5 figures and 1 table
- 6195 total “words” < 7,500 “word” limit

Submitted August 1, 2006

## Using GPS Travel Data to Assess the Real World Driving Energy Use of Plug-in Hybrid Electric Vehicles (PHEVs)<sup>1</sup>

Jeffrey Gonder, Tony Markel, Andrew Simpson, and Matthew Thornton  
*National Renewable Energy Laboratory*

### ABSTRACT

Hybrid electric and plug-in hybrid electric vehicles provide an avenue toward improved vehicle efficiency and significant reductions in petroleum consumption in the transportation sector. Knowledge of typical driving behavior is critical for such advanced vehicle design. Detailed travel survey data collected using GPS units for 227 unique consumer vehicles in the St. Louis metropolitan area was used to assess the fuel consumption and operating characteristics of conventional, hybrid electric, and plug-in hybrid electric vehicle technologies under real-world usage patterns. In comparison to standard cycles used for certification procedures, the travel survey duty cycles include significantly more aggressive acceleration and deceleration events across the velocity spectrum, which impacts vehicle operation and efficiency. Even under these more aggressive operating conditions, a plug-in hybrid electric vehicle using a blended charge-depleting energy management strategy would be expected to consume less than 50% of the petroleum used by a similar conventional vehicle. This study highlights new opportunities for using available GPS travel survey data and advance vehicle systems simulation tools to improve vehicle design and maximize the benefits of energy efficiency technologies.

### INTRODUCTION

The United States (U.S.) is faced with a transportation energy problem. The transportation sector is almost entirely dependent on a single fuel – petroleum. The future of petroleum supply and its use as the primary transportation fuel threatens both personal mobility and economic stability. The U.S. currently imports nearly 60% of the petroleum it consumes and dedicates over 60% of its petroleum consumption to transportation (1). As domestic production of petroleum steadily declines while U.S. consumption continues to climb, imports will also continue to increase. Internationally, the growing economies of China and India continue to consume petroleum at rapidly increasing rates. Many experts are now predicting that world petroleum production will peak within the next 5-10 years (2). The combination of these factors will place great strain on the supply and demand balance of petroleum in the near future.

Hybrid electric vehicle (HEV) technology presents an excellent way to reduce petroleum consumption through efficiency improvements. HEVs use energy storage systems combined with electric motors to improve vehicle efficiency by enabling engine downsizing and by recapturing energy normally lost during braking events. A typical HEV will reduce gasoline consumption by about 30% over a comparable conventional vehicle. This number could approach 45% with additional improvements in aerodynamics and engine technology. Since their introduction in the U.S., HEV sales have grown at an average rate of more than 80% per year. However, after 5 years of availability, they represent only 0.1% of the total U.S. vehicle fleet. There are 237 million vehicles on the road today and more than 16 million new vehicles sold each year (3). Each new vehicle (the vast majority of which are non-hybrids) will likely be in-use for more than 15 years (4). With continued growth in the vehicle fleet and in average vehicle miles traveled (VMT) even aggressive introduction rates of efficient HEVs to the market will only slow the increase in petroleum demand. Reducing U.S. petroleum dependence below present levels requires vehicle innovations beyond current HEV technology.

---

<sup>1</sup> This work has been authored by an employee or employees of the Midwest Research Institute under Contract No. DE-AC36-99GO10337 with the U.S. Department of Energy. The United States Government retains and the publisher, by accepting the article for publication, acknowledges that the United States Government retains a non-exclusive, paid-up, irrevocable, worldwide license to publish or reproduce the published form of this work, or allow others to do so, for United States Government purposes.

Plug-in hybrid electric vehicle (PHEV) technology is an option with the potential to displace a significant portion of transportation petroleum consumption by using electricity for portions of trips. A plug-in hybrid vehicle is an HEV with the ability to recharge its energy storage system with electricity from the utility grid. With a fully-charged energy storage system, the vehicle will bias towards using electricity over liquid fuels. A key benefit of plug-in hybrid technology is that the vehicle is no longer dependent on a single fuel source. The primary energy carrier would be electricity generated using a diverse mix of domestic resources including coal, natural gas, wind, hydro, and solar energy. The secondary energy carrier would be a chemical fuel stored on the vehicle (i.e. gasoline, diesel, ethanol, or even hydrogen).

PHEV technology is not without its own technical challenges. Energy storage system cost, volume, and life are the major obstacles that must be overcome for these vehicles to succeed. Nonetheless, this technology provides a relatively near-term possibility for achieving petroleum displacement. One of the key factors in assessing the potential fuel use reductions of PHEVs is to assess their fuel use relative to both conventional vehicles and other advanced technology vehicles, such as HEVs. This would traditionally be accomplished using controlled chassis dynamometer testing over standardized certification cycles (i.e. Urban Dynamometer Driving Schedule (UDDS), Highway Fuel Economy Test (HWFET) and the US06 Cycle). Several past studies have evaluated the fuel economy benefits from simulated PHEVs over such certification cycles (5, 6). Although these standard test cycles are widely accepted for this type of analysis, the results are somewhat limited since the cycles do not necessarily represent actual driving behavior. One alternative option is to use real-world vehicle usage to generate vehicle driving profiles from which to accurately predict the fuel consumption benefits of advanced technology vehicles. Consideration of real-world usage is of particular importance for the evaluation of PHEVs since their fuel and electricity use are highly sensitive to cycle distance and intensity.

The drawback of real-world performance evaluation is often the availability of good travel data. Typical paper-based travel surveys do not provide sufficiently detailed information to perform advanced vehicle simulations. However, the second-by-second information on vehicle position, heading and speed collected from global positioning system (GPS) technology can be used to create real-world drive cycles. GPS technology uses satellite signals to track the location of vehicles, and can enhance traditional travel survey data collection methods. The purpose of this paper is to illustrate the use of GPS travel data for assessing the fuel use of PHEV technologies in a real world context. This will be accomplished by comparing the liquid fuel and electric energy use of conventional vehicles, HEVs, and PHEVs, simulated over certification cycles with that of a simulated fleet over real world driving activity sampled from an actual urban fleet using GPS technology.

#### **OBTAINING DRIVE CYCLES FROM GPS TRAVEL SURVEY DATA**

Metropolitan planning organizations (MPOs) regularly collect data in travel surveys in order to update transportation demand forecasting models and identify transportation needs and areas of traffic congestion within the survey region. These surveys typically consist of mail out/mail back travel diaries, and may also include a computer-assisted telephone interview (CATI) component. In recent years, several MPOs have begun investigating use of GPS technology in order to improve the accuracy and completeness of personal travel data collection. The first significant deployment of GPS equipment in a travel survey occurred in Austin in 1998. However, the usefulness of the data was limited due to the U.S. government's intentional degradation of GPS data signals (known as "Selective Availability"). On May 1, 2000 President Clinton announced the termination of Selective Availability, which led to ten-fold improvements in GPS data accuracy down to 5-10 meters, literally overnight. It has only been in the relatively recent time period following this change that continually improving GPS accuracy and declining equipment costs have made it practical to include a GPS data collection component in traditional travel surveys.

The East-West Gateway Coordinating Council (EWGCC) became one of the initial pioneers by including a GPS component in the 2002 St. Louis Regional Travel and Congestion Survey. The GPS

devices in the St. Louis study were used to investigate trip characteristics of a sub-sample of participants in the larger survey. The purpose of comparing the GPS and CATI survey results was to gain insight into the extent of under- or mis-reported trips, which has long been a problem with household travel studies due to the self-reporting nature of traditional survey methods. For more details on the full survey and the GPS augment than is provided in this section, the interested reader should consult the final reports on the St. Louis survey methodology and results (7, 8).

In the full St. Louis survey, 5,094 households were used to represent 968,533 households and 2,428,730 persons in the region. Households participating in the GPS augment to the survey were provided a GeoStats GeoLogger™ data collection device for up to three vehicles in the household. To utilize the data logger the survey participant needed only to plug the power connector into the vehicle's cigarette lighter socket, and use a magnetic mount to attach the combination GPS receiver/antenna to the roof of the vehicle. To filter out non-movement events, each GeoLogger was set to record data points for vehicle speeds greater than 1 mph at one-second logging frequencies. The data recorded included date, time, latitude, longitude, speed, heading, altitude, number of satellites, and horizontal dilution of precision (HDOP, a measure of positional accuracy). A 150 household sub-sample of the 5,094 households successfully completing the CATI survey also successfully completed the GPS portion of the survey. From these 150 households, 300 vehicles received GPS instrumentation, and 227 of these 300 vehicles recorded travel on the assigned travel day (a weekday between September 5 and December 12, 2002).

To satisfy the additional use of the GPS data identified in this paper, the second-by-second speed vs. time history logged by the 227 vehicles was converted into a set of 24-hour driving profiles to describe the behavior of these vehicles over a full day. The authors then used a vehicle simulation model to predict the performance and energy consumption of a simulated vehicle operating over the driving profiles. Simulation or testing time constraints often necessitate constructing a single composite cycle to approximately represent such a large set of driving profiles. However, the rapid computational speed of the model described in the following section enables individual simulation of vehicle performance over each distinct 24-hour drive cycle. The subsequent fleet-level simulation result enhances understanding of the distribution and details of vehicle performance that a single composite cycle cannot provide.

The sample distribution for the GPS portion of the St. Louis survey was designed to mirror the population breakdown in the St. Louis area as well as the full study sample distribution. However, extracting conclusions about the larger St. Louis population from the simulation results using GPS-derived drive cycles requires first applying expansion factors to appropriately weight each category of vehicle/household based on its proportion in the larger population (based on household size, location, income, etc). Because the GPS sub-sample represents such a small portion of the total population, the uncertainties associated with applying expansion factors could potentially be large. Nevertheless, analyzing vehicle performance over hundreds of real-world drive cycles can certainly provide expanded insight over solely simulating a handful of synthetic profiles. By referencing recent travel surveys that include a GPS component, large numbers of real-world simulation cycles can be extracted from data originally obtained for another purpose, thus furthering the usefulness of the survey information.

## **PREPARING AND RUNNING VEHICLE SIMULATIONS**

The driving profiles extracted from the travel survey data were used to assess the real-world performance expectations of PHEVs. The second-by-second speed profiles for each vehicle were provided as input to a vehicle systems simulation tool. ADVISOR™ was the particular software tool used for the detailed vehicle simulations. This program was developed at the National Renewable Energy Laboratory with support from the U.S. Department of Energy and has been refined over many years. The tool provides sufficient detail to understand the impact of component sizing and energy management decisions yet is fast enough to analyze 24 hours of driving for a fleet of vehicles in a reasonable amount of time.

ADVISOR is a vehicle systems simulation tool used to assess the fuel consumption and performance of advanced technology vehicles such as hybrid electric, fuel cell, and plug-in hybrid electric vehicles (9). It also includes models for conventional and electric vehicles. The driving profile serves as a key input along with component attributes. Starting from the acceleration demands of the driving profile,

ADVISOR determines the operating point (torque and speed or current and voltage) of each component within the powertrain at each instant in time while accounting for component losses and limitations. ADVISOR has the ability to model a variety of powertrain configurations including parallel, series, and power-split hybrid architectures. For this study all hybrids have been assumed to be in a parallel architecture so that the engine and electric motor can both provide power in parallel to the drive shaft at any time.

A previous paper (10) analyzed the various design options for plug-in hybrid electric vehicles. The two primary PHEV design parameters are the usable energy content of the battery and the rated power of the battery. All other parameters depend on the choice of battery power and energy, the vehicle attributes, and the performance constraints. For this study, the vehicles were assumed to be representative mid-size sedans (similar to a Chevrolet Malibu or a Toyota Camry) with performance that would be competitive in today's market. Table 1 summarizes the attributes of the vehicles considered.

**TABLE 1 Simulated Vehicle Attributes**

	<u>Units</u>	<u>Conventional</u>	<u>Hybrid</u>	<u>PHEV20</u>	<u>PHEV40</u>
Engine Power	<i>kW</i>	121.7	82	79.4	81.9
Motor Power	<i>kW</i>	n/a	39	43.6	48
ESS Power	<i>kW</i>	n/a	50	47	51.8
ESS Energy (total)	<i>kWh</i>	n/a	1.9	9.4	18.5
Curb Mass	<i>kg</i>	1429	1399	1488	1567
Fuel Economy (urban/highway)	<i>mpg</i>	26	39.2	54	67.4
Electric Consumption (urban/highway)	<i>Wh/mi</i>	n/a	n/a	95	157
All Electric Range – urban	<i>miles</i>	n/a	n/a	22.3	35.8

The increased mass of the PHEV will increase its energy consumption rate. However, the larger energy storage system allows it to use the electric drivetrain more often to provide an overall energy efficiency improvement and petroleum displacement benefit. The energy storage system and traction motor have been sized to provide sufficient power to drive the entire UDDS without the use of the engine. The distance a PHEV can drive on a particular cycle before having to turn on its engine is known as the all-electric range. The PHEV20 in this study has been sized with sufficient energy to drive ~20 miles on the UDDS without the use of the engine. Likewise, the PHEV40 has sufficient energy to drive ~40 miles on the UDDS. On other more aggressive cycles the all-electric operation will be less than as designed for urban travel since the engine will need to supplement the electric motor power output in order to follow the driving profile.

The energy management strategy for the PHEVs in this study will attempt to run all-electrically (without the use of a combustion engine) as much as possible as long as the battery has sufficient energy. However, if the electric drivetrain power is insufficient to satisfy the immediate needs of the driver the combustion engine will be used to supplement the electric drivetrain. As the stored energy in the battery becomes depleted the vehicle will transition into a charge-sustaining mode, in which the engine will become the primary power source and the stored energy will be used to allow the engine to operate as efficiently as possible. This is referred to as a blended charge-depleting strategy (11) or as an electric vehicle centric strategy (12) and is intended to provide as much petroleum displacement as possible for a given set of components.

**ANALYSIS RESULTS**

The 227 unique driving profiles derived from the St. Louis GPS survey together represent 8650 miles of travel. Figure 1 shows the distribution of daily distance traveled for this sample data set. Approximately 5% of the vehicles traveled more than 100 miles with the one vehicle traveling 270 miles. PHEV fuel efficiency and petroleum displacement impact is strongly associated with the daily distance traveled between recharge events.

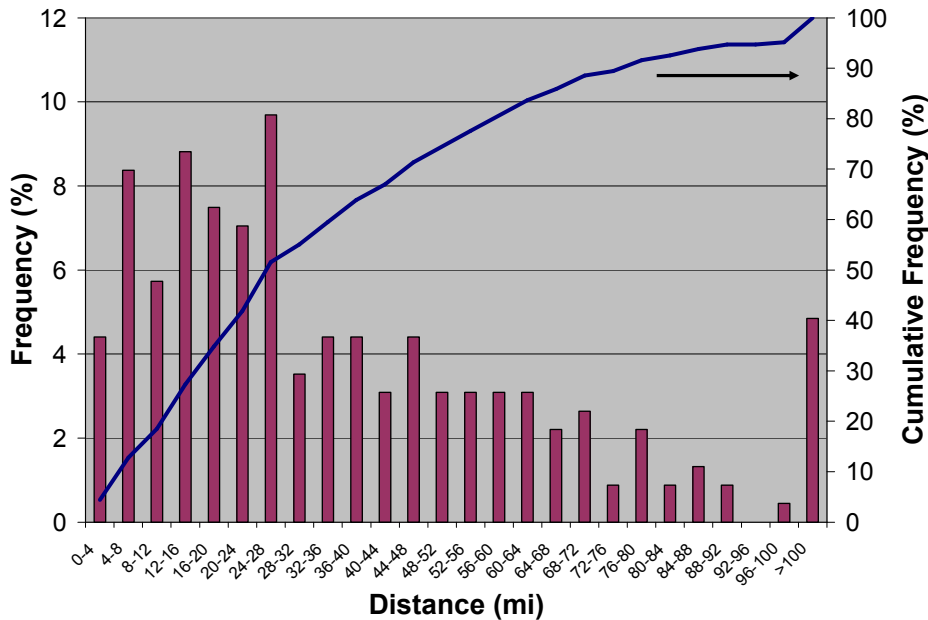

**FIGURE 1 Daily driving distance distribution for 227 vehicles in the St. Louis metropolitan area.**

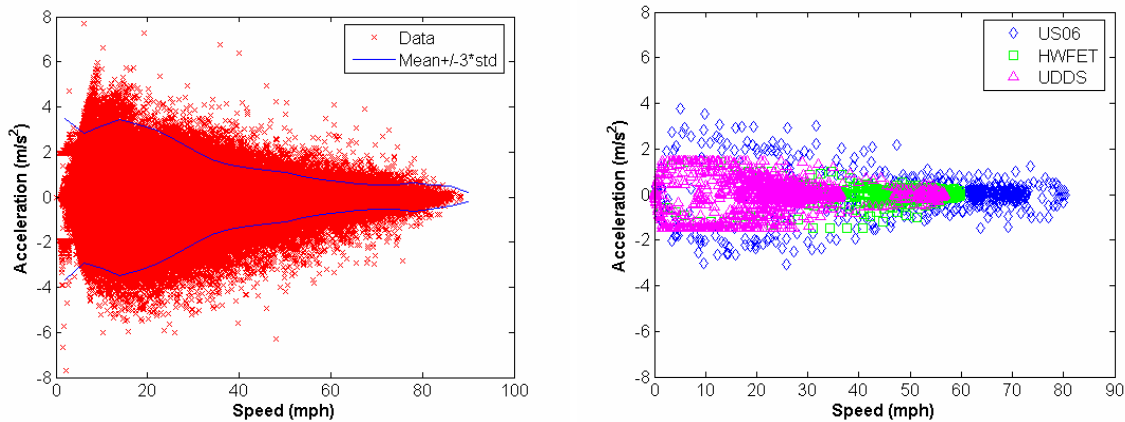

**FIGURE 2 Comparison between acceleration characteristics of real-world and standard driving cycles.**

In addition to the daily driving distance, the real data provides valuable insight into driving behavior. As it relates to vehicle design, the rate of acceleration and the speed at which this acceleration occurs is critical in determining the required power capabilities of the hybrid vehicle components. In Figure 2, acceleration is plotted against speed for the entire set of vehicles in the sample real-world data set on the left and for three standard driving profiles on the right. The UDDS and HWFET are used to represent typical urban and highway driving by the Environmental Protection Agency (EPA) for the

purposes of standardized labeling of vehicle fuel economies. The US06 cycle includes more high speed and more aggressive accelerations than either the UDDS or HWFET. EPA has proposed using results from the US06 to improve vehicle fuel economy labeling to be more representative of what consumers might expect to see in-use. This figure clearly shows that even the US06 cycle does not fully encompass the range of accelerations seen in this real-world driving sample.

The four vehicles described in Table 1 were each simulated over all 227 driving profiles. Figure 3 presents a summary of the simulation results. The vertical bars are associated with the left axis and represent the percentage of the 227 vehicles in-use (driving) throughout the day. Morning, mid-day and evening peaks in usage are clearly observed. The lines represent the cumulative liquid fuel consumed over the course of the day by the entire fleet of 227 vehicles assuming all vehicles are the specified architecture. The chart suggests that HEV technology was able to reduce fuel consumption by about 29% relative to the conventional case. The PHEV20 technology reduced consumption by almost 55% and the PHEV40 reduced consumption by about 66%. The PHEVs are able to displace this level of petroleum because they attempt to use the stored electrical energy to propel the vehicle as much as possible within the component limits discussed previously.

In addition to gasoline consumption, the PHEVs also consume electrical energy. The fleet consumed 1212 kWh and 1821 kWh for the PHEV20 and PHEV40 configurations respectively. Since the vehicles utilize two different energy sources, it is useful to compare the vehicle configurations on the basis of total energy costs. Assuming costs of \$2.41/gallon for gasoline and \$0.09/kWh for electricity (national averages for 2005) results in average operating costs of 9.1c/mile for the Conventional fleet, 6.5c/mile for the HEV fleet, 5.4c/mile for the PHEV20 fleet and 5.1c/mile for the PHEV40 fleet.

The simulation results indicate that PHEVs would provide substantial petroleum displacement benefits and reduce vehicle fuel costs for this “real-world fleet.” The reduced engine use, particularly during the morning commute in Figure 3 (when emissions provide the greatest contribution to smog formation) indicates that PHEVs may also provide an emissions benefit. However, further simulations will be necessary to quantify the emissions impact of PHEV technology since vehicle emissions are highly dependent on transient and on/off engine operation.

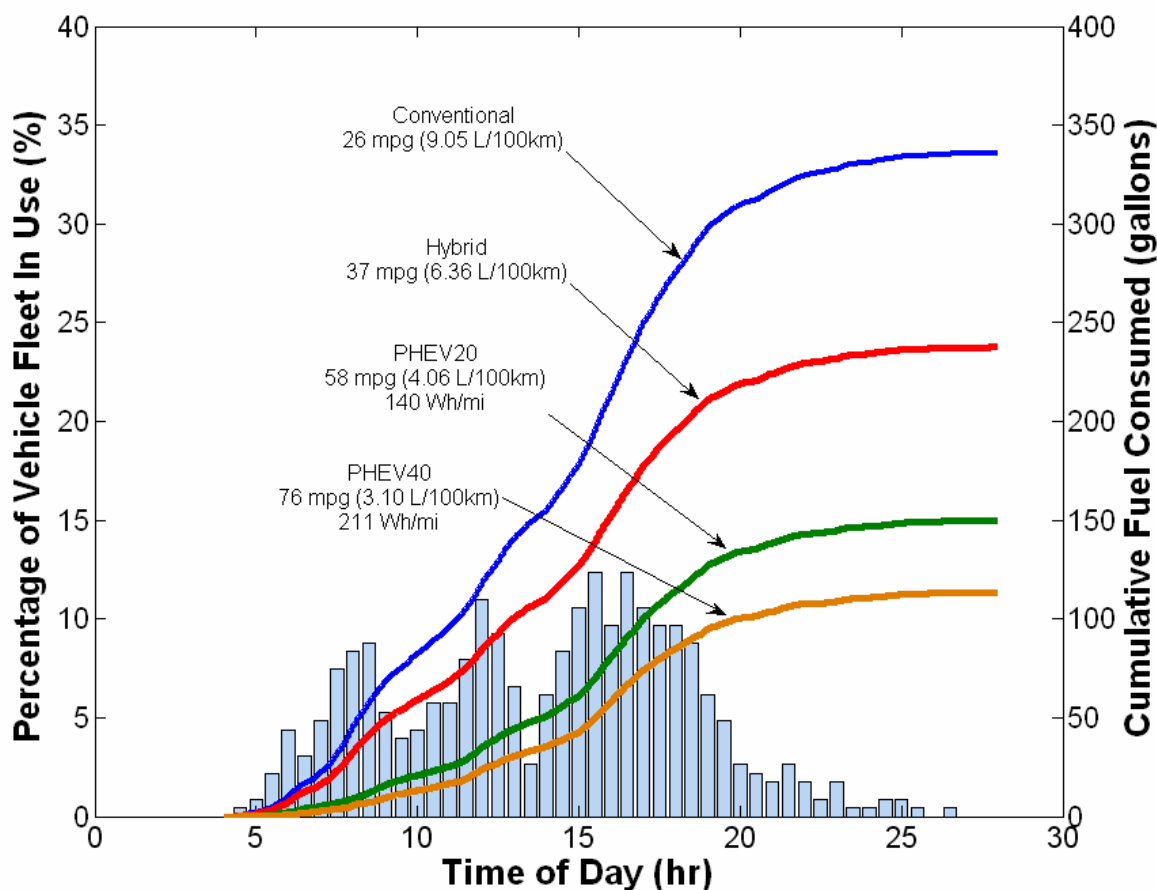

**FIGURE 3 In-use activity pattern for 227 vehicles; cumulative fleet and average vehicle consumption results for four vehicle technologies.**

Figure 3 showed the consumption results for the entire fleet of 227 vehicles as a single result. Because detailed simulations were completed for each vehicle, it is also possible to examine the specific vehicle-level simulation results. Figure 4 shows the distribution of fuel consumption values for all of the vehicles in each of the four configuration scenarios. The bars represent the percentage of the fleet of 227 vehicles that achieved fuel consumption values within the indicated consumption range (each bar represents a range of 0.5L/100km). The vertical lines represent the fuel use on standard cycles (red=US06 and green=City/Highway composite). The city and highway composite value is determined by weighting the UDDS fuel economy by 55% and the HWFET fuel economy by 45%. In addition, the PHEV certification cycle values include a utility factor of 0.35 for the PHEV20 and 0.5 for the PHEV40 in order to account for the split between charge depleting and charge sustaining operation that a once-daily charged PHEV experience based on national driving statistics (13). The weighting factors are intended translate measured certification cycle results into realistic in-use values.

The first important insight from Figure 4 is that a large portion of the PHEV20 and PHEV40 vehicles have real-world fuel consumption values much lower than those predicted by standard certification cycles, whereas a large portion of the conventional and HEV results are greater than the corresponding standard cycle results. From the perspective of most drivers in this real-world fleet, this result suggest that a PHEV is likely to over-deliver on fuel efficiency expectations while conventional and HEVs will likely under-deliver. A second important observation is that for both the PHEV20 and the PHEV40 nearly all vehicles in the fleet have fuel consumption values less than all of the conventional or



HEV vehicles. Whereas Figure 3 indicated PHEVs provide a large average fleet petroleum consumption benefit, this result suggests that the reduced petroleum consumption experienced across the range of individual vehicle real-world driving profiles.

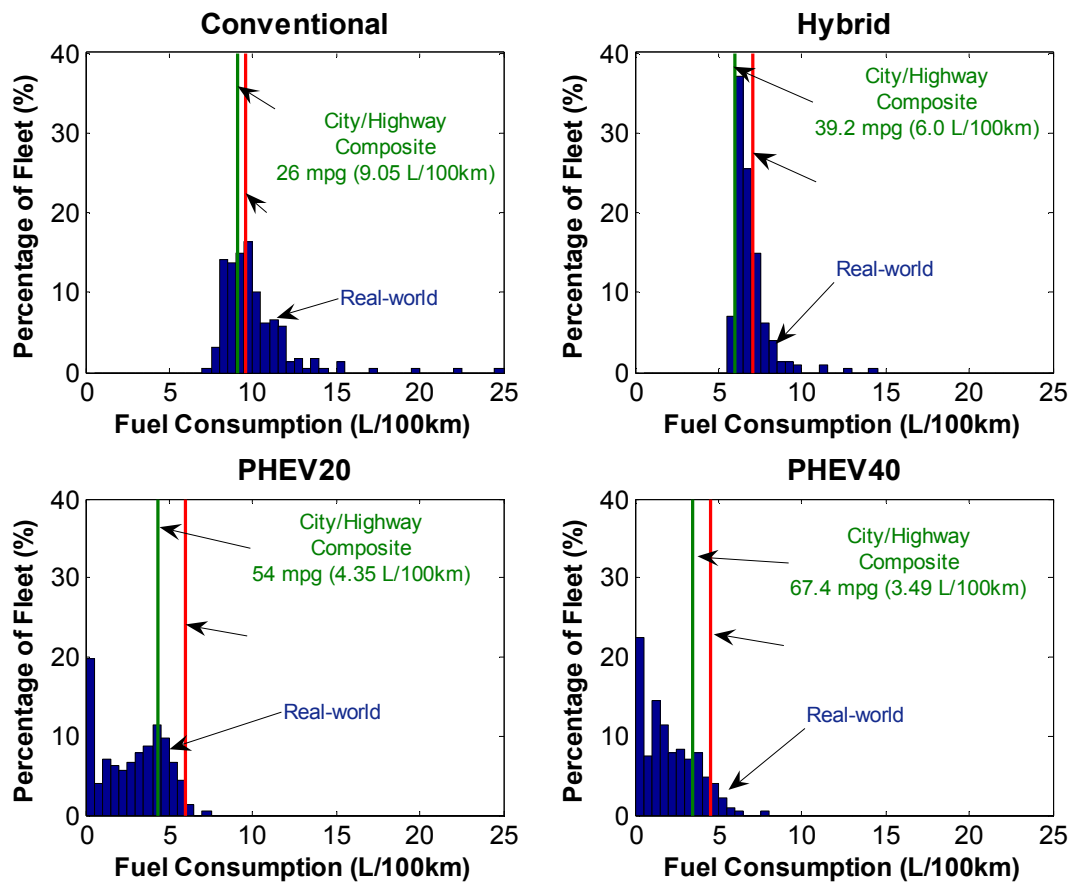

**FIGURE 4 Comparison of fuel consumption distributions for various vehicle architectures.**

Much recent discussion of plug-in hybrids has focused on the ability of the vehicles to operate without the use of the combustion engine (to maximize the previously defined “all-electric range” of the vehicle). As stated for this analysis, the PHEV20 and PHEV40 were respectively designed to provide 20 miles and 40 miles of all-electric range capability on the UDDS cycle. Since the examined real-world cycles were shown in Figure 2 to be much more aggressive than the UDDS, the actual in-use all-electric range could be substantially less than the designed 20 and 40 mile distances. Figure 5 confirms that a large percentage of the vehicles achieved less than 5 miles of all-electric range over the real-world cycles. Even so, it is important to recognize that these vehicles achieve significant petroleum displacement without necessarily realizing substantial all-electric range.

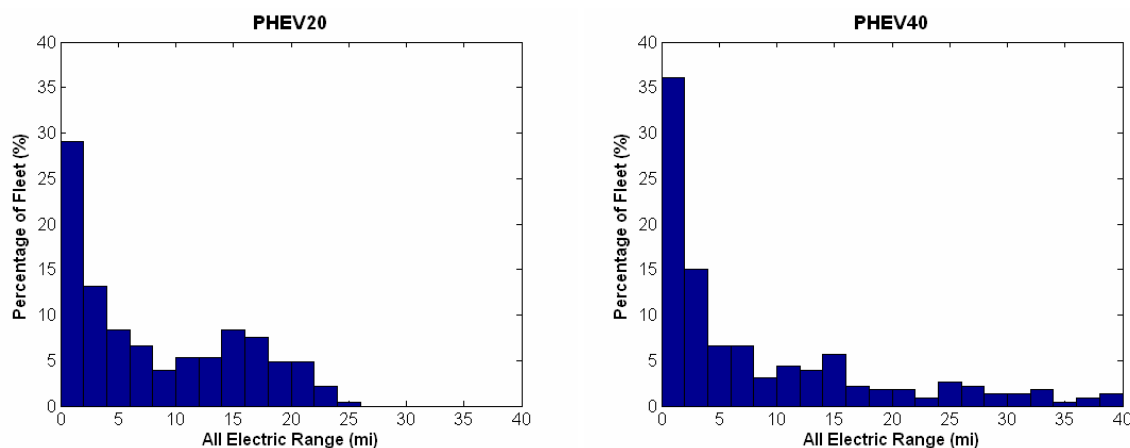

**FIGURE 5 In-use all-electric range performance of plug-in hybrid vehicles designed for urban cycle all-electric range.**

## CONCLUSIONS

Relatively recent advances in GPS technology and reductions in equipment cost have enabled metropolitan planning organizations to begin incorporating a GPS component into the travel surveys they conduct. GPS helps enhance the data collected for the intended transportation planning purpose, but also presents an opportunity for new uses of this existing data due to the enhanced temporal resolution on individual vehicle driving profiles. In particular, vehicle simulation tools can utilize the resulting second-by-second drive cycles to make predictions on how different vehicle technologies will perform under the real-world driving conditions captured by the GPS survey. The speed and accuracy of modern vehicle system simulation tools, such as the ADVISOR software discussed in this paper, enable direct simulation of a range of vehicle technologies over each individual 24-hour driving profile collected in the survey. Examining performance over a range of real-world cycles provides insights beyond only conducting a small number of simulations over “standard” cycles or an aggregate cycle intended to “represent” the spectrum of real-world cycles collected.

For the specific example of PHEV technology, the detailed GPS drive cycles can provide information on the time of day and duration of different driving behaviors, as well as where the vehicle parks when not in use. This information can be used to predict different charging scenarios that a PHEV fleet might experience throughout a given day. Further analysis (not directly discussed in this paper) could examine the implications of fleet recharging on the electrical utility grid in addition to the impacts on the vehicles themselves. Real-world fleet driving data can also help quantify the range of vehicle operation patterns and acceleration intensities. This information can help vehicle designers make more informed design decisions, such as understanding for a PHEV how much all-electric range actual drivers are likely to experience for a given motor size. Finally, the detailed fleet driving simulations can be used to predict the benefit that advanced vehicle technologies (which can be sensitive to driving type and distance) could provide in real-world use. Over the 227 drive profiles taken from the St. Louis GPS survey, the simulations in this paper predict that replacing a fleet of conventional midsize vehicles with a fleet of comparable PHEVs would provide an approximately 50% reduction in petroleum use.

The next steps planned for this analysis include segregating the St. Louis drive cycle simulations by vehicle platform. Because the survey collected information on the make and model of each instrumented vehicle, it is possible to analyze the impact of replacing the conventional midsize vehicles with midsize PHEVs, the conventional sport utility vehicles with sport utility PHEVs, etc (rather than assuming all vehicles in the fleet are identical). The analysis can also go further to examine any correlation between vehicle or household attributes and driving behavior. Another key supplement to the analysis will be application of statistical expansion methods in order to define what conclusions about the larger St. Louis area can be drawn from the GPS drive cycle simulation results. Because the 227 vehicle sample is a relatively small subset of the vehicles in the area, the uncertainties accompanying any data

expansion will be fairly large. It is, therefore, also important to continue seeking out more and larger GPS data sets on which to perform similar simulations. Decreasing GPS survey costs and formation of partnerships between multiple users of the collected data will help increase the scope and quality of the GPS driving information and subsequent results expansion. Such expanded use of GPS data could help more accurately predict how specific advanced technologies will benefit a particular area.

#### ACKNOWLEDGEMENT

The authors would like to acknowledge the programmatic support of the U.S. Department of Energy Office of Energy Efficiency and Renewable Energy FreedomCAR and Vehicle Technologies Program. Additionally, we'd like to thank Jean Wolf of GeoStats and Todd Brauer of East-West Gateway Council of Governments for providing access to the GPS travel survey data.

#### REFERENCES

1. U.S. Energy Information Administration. [www.eia.doe.gov](http://www.eia.doe.gov). Accessed July 10, 2006.
2. Hirsch, R., R. Bezdek, and R. Wendling. Peaking of World Oil Production: Impacts, Risks, and Mitigation. U.S. Department of Energy. February, 2005. [http://www.netl.doe.gov/energy-analyses/pubs/Oil\\_Peaking\\_NETL.pdf](http://www.netl.doe.gov/energy-analyses/pubs/Oil_Peaking_NETL.pdf).
3. *Highway Statistics 2004*. U.S. Department of Transportation. Federal Highway Administration. <http://www.fhwa.dot.gov/policy/ohim/hs04/index.htm>.
4. Davis, S. and S. Diegel. *Transportation Energy Databook: Edition 24*. December, 2004.
5. R. Graham, et al. Comparing the Benefits and Impacts of Hybrid Electric Vehicle Options. Electric Power Research Institute (EPRI), Palo Alto, CA, EPRI Report #1000349. July, 2001.
6. Plotkin, S., et al. Hybrid Electric Vehicle Technology Assessment: Methodology, Analytical Issues, and Interim Results. Argonne Report # ANL/ESD/02-2. October 2001.
7. *Household Travel Survey: Final Report of Survey Methodology*. East-West Gateway Coordinating Council. January 31, 2003. <http://www.ewgateway.org/pdffiles/library/trans/travelsurvey/StLouisFinalMethodsReport.pdf>.
8. *Household Travel Survey: Final Report of Survey Results*. East-West Gateway Coordinating Council. January 31, 2003. <http://www.ewgateway.org/pdffiles/library/trans/travelsurvey/StLouisFinalAnalysisReport.pdf>.
9. Markel, T., et al. ADVISOR: A Systems Analysis Tool for Advanced Vehicle Modeling. *Journal of Power Sources*, v. 110, 2002, pp. 255-266.
10. Markel, T. and A. Simpson. Plug-In Hybrid Electric Vehicle Energy Storage System Design. *Advanced Automotive Battery Conference*. Baltimore, MD. May 17-19, 2006.
11. Markel, T. and A. Simpson. Energy Storage Considerations for Grid-Charged Hybrid Electric Vehicles. *IEEE Vehicular Technologies Conference*. Chicago, IL. September 7-9, 2005.
12. O'Keefe, M. and T. Markel. Dynamic Programming Applied to Investigate Energy Management Strategies for a Plug-In HEV. To be published at 22<sup>nd</sup> *International Battery, Hybrid and Fuel Cell Electric Vehicle Symposium & Exposition (EVS-22)*. Yokohama, Japan. October 23 - 28, 2006.
13. Gonder, J. and A. Simpson. Measuring and Reporting Fuel Economy of Plug-In Hybrid Electric Vehicles. To be published at 22<sup>nd</sup> *International Battery, Hybrid and Fuel Cell Electric Vehicle Symposium & Exposition (EVS-22)*. Yokohama, Japan. October 23 - 28, 2006.

# Section 4

## Plug-In Hybrid Electric Vehicle Energy Management Strategies

Discussion in many PHEV forums has focused on how the PHEV will function and, more specifically, on how the vehicle will use the battery and engine in combination to improve efficiency and displace petroleum.

NREL's vehicle systems analysis team has a long history of applying optimization tools to explore hybrid electric vehicle energy management strategies. During the past fiscal year, two parallel efforts were initiated. The first explored the extensive PHEV design space and identify promising regions (using the modeling techniques developed for the cost-benefit study). The second applied dynamic programming techniques to determine the "near optimal" power distribution among the engine, motor, and battery in a PHEV for a known driving profile. NREL's energy management strategy work is critical for maximizing the petroleum savings while protecting the batteries of future hybrid vehicles.

The conclusions from these analyses are:

- The misconception that a PHEV<sub>x</sub> must drive using electricity for the first x miles and then use the engine for the remaining travel must be clarified. This is one strategy that a manufacturer may choose to pursue, but it is not the only strategy. As long as the strategy is achieving a net discharge of the battery, petroleum will be displaced, regardless of whether the vehicle is operated on battery only or on a combination of battery and engine power (known as a "blended" control strategy).
- The selection of strategy and component sizing are not entirely independent. Reducing the rated power and size of the electric traction components is one way to reduce the cost of a PHEV. Reducing electric components also necessitates the use of a "blended" strategy. The "blended" strategy can still utilize electric propulsion to the maximum extent possible to minimize the vehicle's instantaneous fuel use. NREL's analysis shows that a PHEV with electric traction components half the size (based on power) of an all-electric PHEV can provide nearly the same petroleum reduction as an all-electric PHEV.
- Dynamic programming optimization of PHEV energy management strategies indicated that optimum control based on *a priori* knowledge of the driving cycle provided marginally better petroleum savings than a strategy that used stored electric energy to the greatest extent possible. On the other hand, if the real-world driving distance turned out to be less than that predicted for dynamic programming, then the "optimally" blended strategy would consume significantly more fuel than the electric energy-focused strategy over the length of the shortened driving distance. Note, however, that the simulations supporting these results were limited to repetitions of identical drive cycles. It is possible that drive cycle variation (e.g., an urban followed by a highway followed by an urban pattern) may impact this conclusion.

As PHEV technology evolves, energy management strategy will become increasingly important. It will be used to ensure satisfactory battery life, maximize petroleum displacement, gain performance improvement, and manage vehicle thermal and emissions transients. NREL's future work will apply optimization to more varied driving scenarios and include aspects beyond fuel displacement in the objective function.

For more extensive discussion of this topic, please refer to sections 4.1, 4.2, and 4.3.

# Section 4.1

**Title:** “Plug-In Hybrid Electric Vehicle Energy Storage System Design”

**Type:** Presentation

**Authors:** Tony Markel and Andrew Simpson

**Date:** May 19, 2006

**Conference or Meeting:** Presented at the Advanced Automotive Battery Conference in Baltimore, Maryland

**Abstract:** Discusses the system design trade-offs of battery sizing and control as they relate to cost, fuel economy, and life

# Plug-in Hybrid Electric Vehicle Energy Storage System Design

*Advanced Automotive Battery Conference*  
by  
**Tony Markel and Andrew Simpson**  
**National Renewable Energy Laboratory**

May 19<sup>th</sup>, 2006

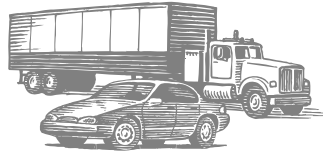

With support from the  
U.S. Department of Energy  
Office of Energy Efficiency and Renewable Energy  
FreedomCAR and Vehicle Technologies Program

Presented at the Advanced Automotive Battery Conference held May 17-19, 2006 in Baltimore, Maryland  
NREL/PR-540-40237

NREL is operated by Midwest Research Institute • Battelle 

## Disclaimer and Government License

This work has been authored by Midwest Research Institute (MRI) under Contract No. DE-AC36-99GO10337 with the U.S. Department of Energy (the "DOE"). The United States Government (the "Government") retains and the publisher, by accepting the work for publication, acknowledges that the Government retains a non-exclusive, paid-up, irrevocable, worldwide license to publish or reproduce the published form of this work or allow others to do so, for Government purposes.

Neither MRI, the DOE, the Government, nor any other agency thereof, nor any of their employees, makes any warranty, express or implied, or assumes any liability or responsibility for the accuracy, completeness, or usefulness of any information, apparatus, product, or process disclosed, or represents that its use would not infringe any privately owned rights. Reference herein to any specific commercial product, process, or service by trade name, trademark, manufacturer, or otherwise does not constitute or imply its endorsement, recommendation, or favoring by the Government or any agency thereof. The views and opinions of the authors and/or presenters expressed herein do not necessarily state or reflect those of MRI, the DOE, the Government, or any agency thereof.

# The Perfect Storm

- Petroleum **consumption** has steadily **increased** while domestic **production** has continued to **decline**
- World oil **production** predicted to **peak** within the next 5-15 years
- Recent increase in **gasoline price** is indicator of **growing tension** between supply and demand

Gasoline price - 85% rise in 5 years!

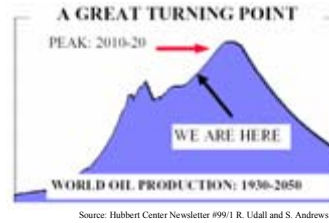
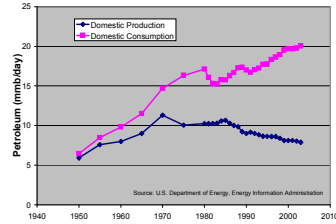
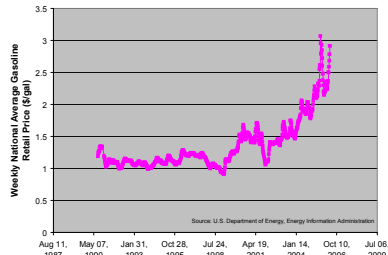

WHAT'S OUR PLAN?

3

# Oil Use Reduction with HEVs

Light Duty Fleet Oil Use - Impact of HEVs on Consumption

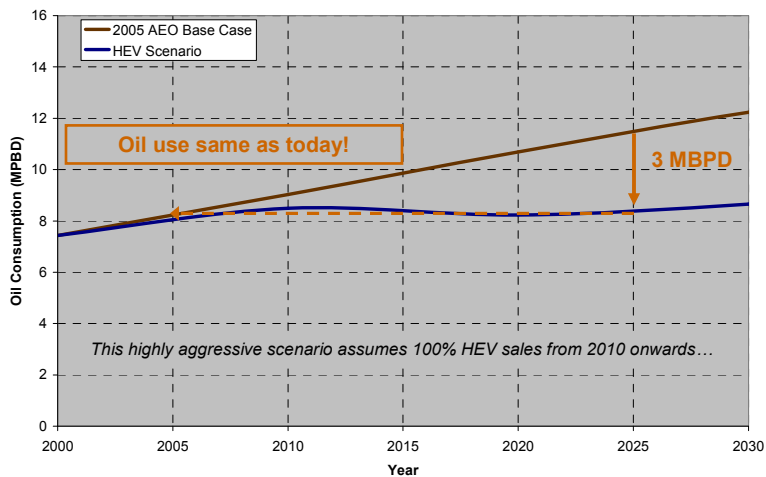

HEVs unable to reduce consumption below today's consumption level

4

Produced using VISION model, MBPD = million barrels per day



# Oil Use Reduction with PHEVs

Light Duty Fleet Oil Use - Impact of PHEVs on Consumption

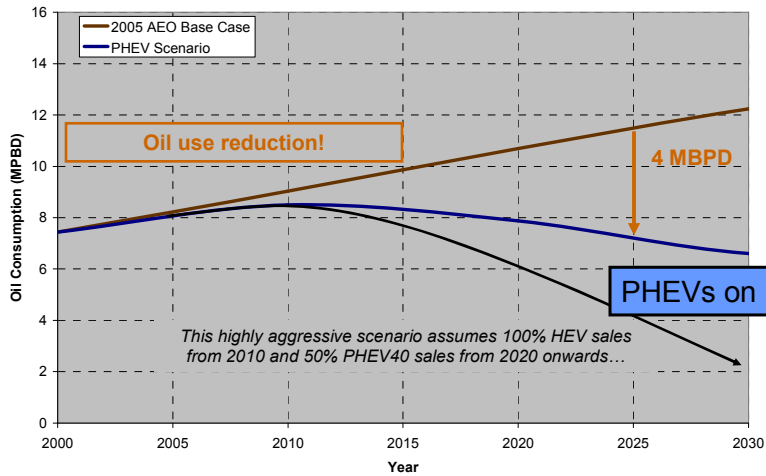

PHEVs reduce oil consumption with a transition to electricity

5

Produced using VISION model, MBPD = million barrels per day



# Recent PHEV Prototypes



EnergyCS Plug-In Prius



HyMotion Escape PHEV



DaimlerChrysler Sprinter PHEV



Renault Kangoo Elect'road



AC Propulsion Jetta PHEV



Esoro AG H301



AFS Trinity Extreme Hybrid™

6





## PHEV Batteries



Johnson Controls / SAFT



Cobasys



Valence Technologies



Hymotion

7



## Battery Characteristics

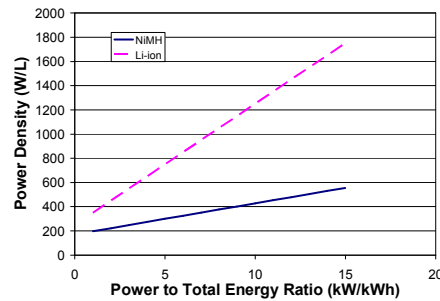

Lower power to energy ratio leads to lighter, smaller, and less expensive energy storage system

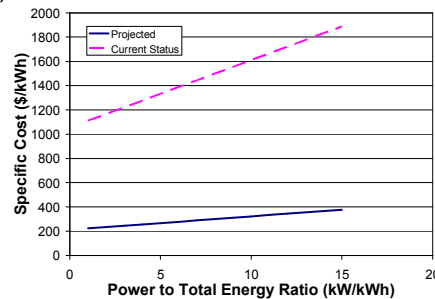
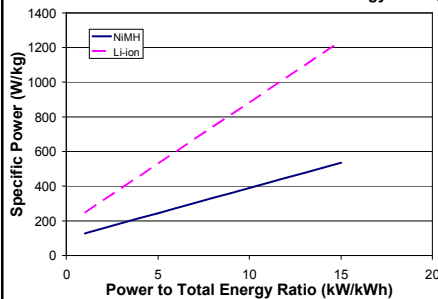

## All-Electric vs Blended Strategy

All-Electric

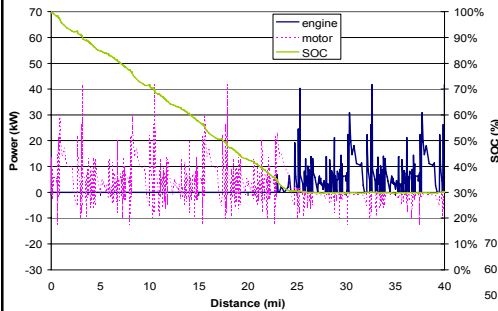

- Engine turns on when battery reaches low state of charge
- Requires high power battery and motor

- Engine turns on when power exceeds battery power capability
- Engine only provides load that exceeds battery power capability

Blended

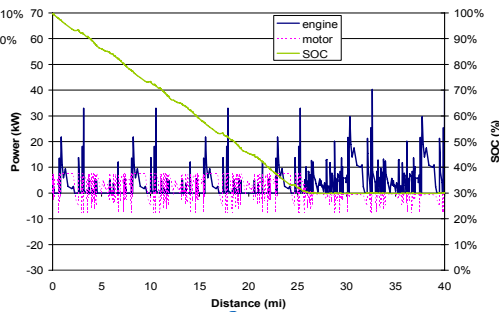

9

## Blended vs. AER Consumption Tradeoff

PHEV20 on LA92

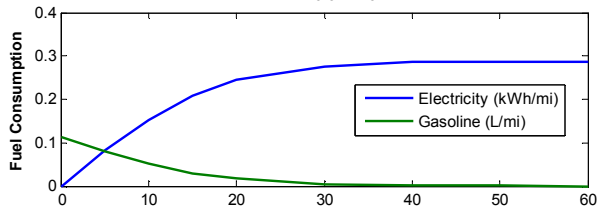

- Reducing ESS power should reduce cost, mass, volume

- 50% reduction in power still provides almost all of the fuel consumption benefit

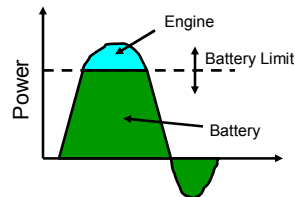
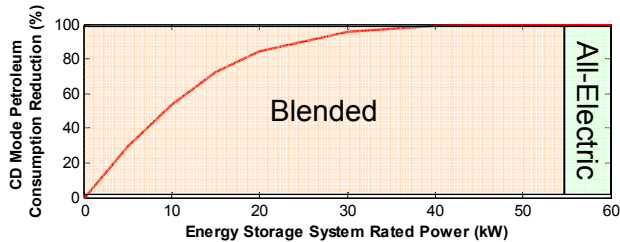

\* CD = Charge Depleting

10

## PHEV Battery Sizing Alternatives

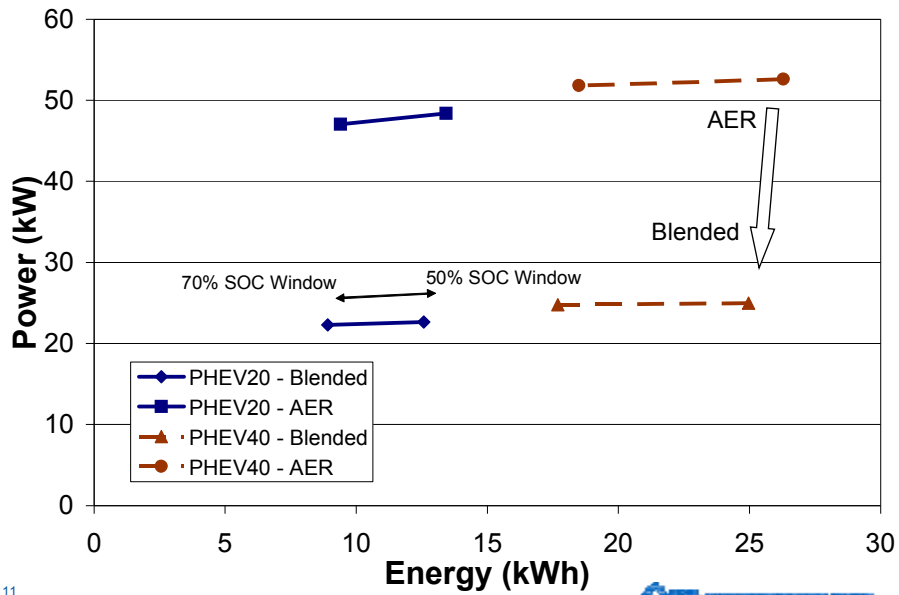

11

## Battery Life

- PHEV battery likely to deep-cycle each day driven: 15 yrs equates to 4000-5000 deep cycles
- Also need to consider combination of high and low frequency cycling

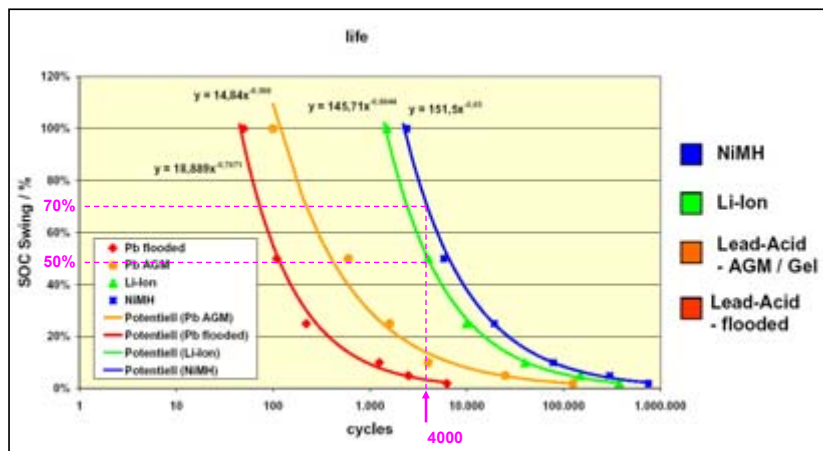

Data presented by Christian Rosenkranz (Johnson Controls) at EVS 20

12

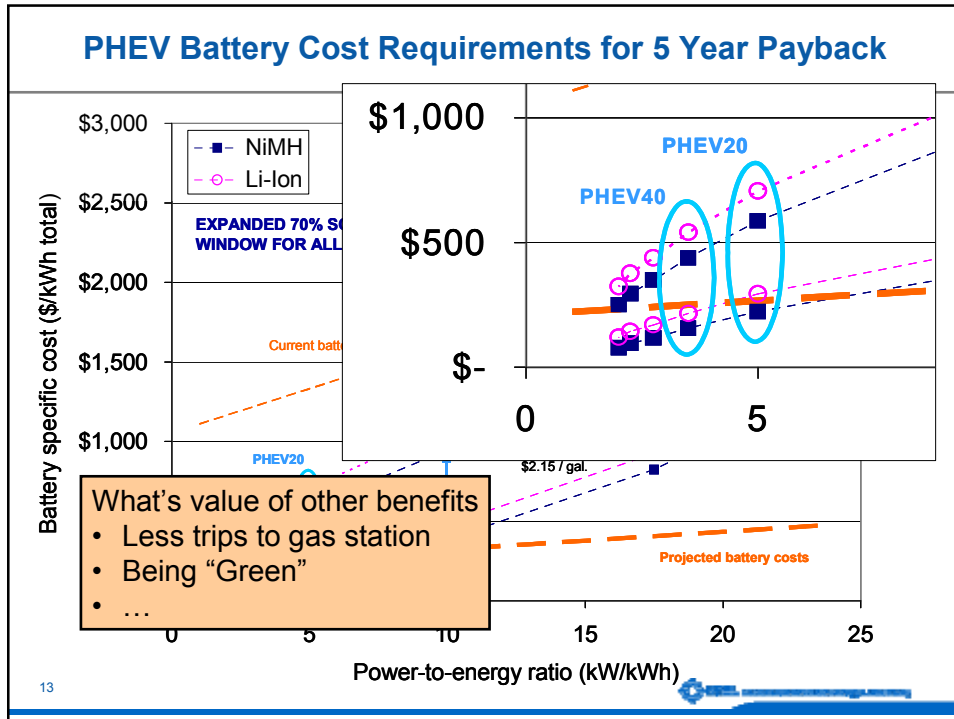

- ## Conclusions
- Plug-in hybrid technology can reduce petroleum consumption beyond that of HEV technology
  - The study highlighted some of the PHEV design options and associated tradeoffs
    - Expansion of the energy storage system usable state of charge window while maintaining life will be critical for reducing system cost and volume
    - A blended operating strategy as opposed to an all electric range focused strategy may provide some benefit in reducing cost and volume while maintaining consumption benefits
  - The key remaining barriers to commercial PHEVs are battery life, packaging and cost
- 14

## Section 4.2

**Title:** “Plug-In Hybrid Electric Vehicle Energy Storage System Design”

**Type:** Paper

**Authors:** Tony Markel and Andrew Simpson

**Date:** May 19, 2006

**Conference or Meeting:** Presented at the Advanced Automotive Battery Conference in Baltimore, Maryland

**Abstract:** Discusses the system design trade-offs of battery sizing and control as they relate to cost, fuel economy, and life

# Plug-In Hybrid Electric Vehicle Energy Storage System Design\*

**Tony Markel and Andrew Simpson**

*National Renewable Energy Laboratory, 1617 Cole Blvd. Golden, Colorado 80401 USA*

## ABSTRACT

Plug-in hybrid electric vehicle technology holds much promise for reducing the demand for petroleum in the transportation sector. Its potential impact is highly dependent on the system design and in particular, the energy storage system. This paper discusses the design options including power, energy, and operating strategy as they relate to the energy storage system. Expansion of the usable state-of-charge window will dramatically reduce cost but will likely be limited by battery life requirements. Increasing the power capability of the battery provides the ability to run all-electrically more often but increases the incremental cost. Increasing the energy capacity from 20-40 miles of electric range capability provides an extra 15% reduction in fuel consumption but also nearly doubles the incremental cost.

## Introduction

The United States is faced with a transportation energy dilemma. The transportation sector is almost entirely dependent on a single fuel – *petroleum*. The continued role of petroleum as the primary transportation fuel should be questioned.

Today, nearly 60% of U.S. total petroleum consumption is imported and results in billions of dollars flowing to the economies of foreign countries. More than 60% of U.S. petroleum consumption is dedicated to transportation.[1] The domestic production of petroleum is steadily declining while our rate of consumption continues to increase; thus imports are expected to continue to increase. Meanwhile, petroleum consumption rates in the emerging economies of China and India are rapidly expanding. Furthermore, experts believe world petroleum production may peak within the next 5-10 years.[2] The combination of these factors will place great strain on the supply and demand balance of petroleum in the near future.

Hybrid electric vehicle (HEV) technology is an excellent way to reduce our petroleum consumption through efficiency improvements. HEVs use energy storage technology to improve vehicle efficiency through engine downsizing and by recapturing energy normally lost during braking events. A typical HEV will reduce gasoline

consumption by about 30% over a comparable conventional vehicle.<sup>1</sup> Since introduced, HEV sales have grown at an average rate of more than 80% per year. However, after 5 years of availability, they represent only 0.1% of the total U.S. vehicle fleet. There are 237,000,000 vehicles on the road today and more than 16 million new vehicles sold each year.[3] New vehicles will likely be in-use for more than 15 years and the vehicle miles traveled (VMT) continues to grow.[4] It will be challenging to overcome the inertia of the vehicle fleet. For instance, if every new vehicle sold in 2011 and beyond was a petroleum-fueled hybrid, our petroleum consumption level 10 years from now would still be 6% greater than the current light-duty fleet consumption, and it would never drop below today's consumption level. Efficiency improvements of HEVs will be insufficient to overcome vehicle fleet and VMT growth expectations.

This presents a challenge of how to best displace as much petroleum consumption as soon as possible while incurring reasonable costs. Many industries, including polymer and pharmaceutical, have little choice but to use petroleum. There are several alternatives to petroleum for a transportation fuel source. These include hydrogen, ethanol, biodiesel, and electricity. Hydrogen and fuel cell technology has advanced rapidly but still faces significant cost, infrastructure, and technical challenges that could limit market penetration within the next 15-20 years. Both ethanol and biodiesel are used today

---

\* Employees of the Midwest Research Institute under Contract No. DE-AC36-99GO10337 with the U.S. Dept. of Energy have authored this work. The United States Government retains and the publisher, by accepting the article for publication, acknowledges that the United States Government retains a non-exclusive, paid-up, irrevocable, worldwide license to publish or reproduce the published form of this work, or allow others to do so, for United States Government purposes.

---

<sup>1</sup> With additional improvements in aerodynamics and engine technology, hybrid vehicles today have demonstrated upwards of a 45% reduction in consumption as compared to a conventional vehicle.

and help displace petroleum. However, at current production levels and given future expectations on cellulosic production potential, biofuels have limited ability to end our oil addiction alone but may be more successful when combined with other displacement technologies.

Plug-in hybrid electric vehicle (PHEV) technology is an option with the potential to displace a significant portion of our transportation petroleum consumption. A plug-in hybrid vehicle is an HEV with the ability to recharge its energy storage system with electricity from the electric utility grid. With a fully charged energy storage system, the vehicle will bias towards using electricity over liquid fuels. A key benefit of PHEV technology is that the vehicle is no longer dependent on a single fuel source. The primary energy carrier is electricity generated using a diverse mix of domestic resources including coal, natural gas, wind, hydroelectric, and solar energy. The secondary energy carrier is a liquid fuel (e.g., gasoline, diesel, or ethanol).

PHEV technology is not without its own technical challenges. Energy storage system cost, volume, and life are major obstacles that must be overcome for these vehicles to be viable. The fuel displacement potential of a PHEV is directly related to the characteristics of the energy storage system. More stored energy means more miles that can be driven electrically. However, increasing energy storage also increases vehicle cost and can present significant packaging challenges. Finally, the energy storage system duty cycle for a PHEV is likely to be more severe from a life standpoint than electric vehicles or HEVs.

The purpose of this paper is to expand on the current understanding of the potential benefits, the design options, and the challenges related to PHEV technology.

### **PHEV and HEV Terminology**

*Charge-sustaining mode* – An operating mode in which the state-of-charge of the energy storage system over a driving profile may increase and decrease but will by the end of the cycle return to a state with equivalent energy as at the beginning of the period.

*Charge-depleting mode* – An operating mode in which the state-of-charge of the energy storage system over a driving profile will have a net decrease in stored energy.

*All-electric range (AER)* – The total distance driven electrically from the beginning of a driving profile to the point at which the engine first turns on.

*Electrified miles* – Is the sum of all miles driven with the engine off including those after the engine first turns on.

*PHEV<sub>xx</sub>* – A plug-in hybrid vehicle with sufficient energy to drive xx miles electrically on a defined driving profile usually assumed to be urban driving. The vehicle may or may not actually drive the initial xx miles electrically depending on the control strategy and driving behavior.

*SOC* – State-of-charge of the energy storage system. The fraction of total energy capacity remaining in the battery.

*Degree of hybridization* – The fraction of total rated power provided by the electric traction drive components.

*Utility factor* – A measure of the fraction of total daily miles that are less than or equal to a specified distance based on typical daily driving behavior.

### **Potential Benefits of PHEVs**

A key reason for exploring PHEV technology is its ability to achieve significant petroleum consumption reduction benefits. A PHEV has essentially two operating modes: a charge-sustaining mode and a charge-depleting mode. The total consumption benefits of a PHEV are a combination of the charge-depleting and charge-sustaining mode improvements.

Figure 1 highlights the relative importance of these two modes in achieving fuel displacement. It shows the total consumption benefit as a function of the improvement in charge-sustaining mode consumption for HEVs and PHEVs with several electric range capabilities. Several current model hybrid vehicles are included. Today's HEVs do not have a charge-depleting mode, so their total consumption benefits are derived solely from improvements in the charge-sustaining mode. The large dots on the plot present three scenarios that achieve 50% reduction in total petroleum consumption. A PHEV40 that consumed no petroleum (all-electric operation) in charge-depleting mode with a fuel economy in charge-sustaining mode equivalent to a conventional vehicle would consume 50% less petroleum because the first 40 miles of driving would be done electrically. Likewise, a PHEV20 that

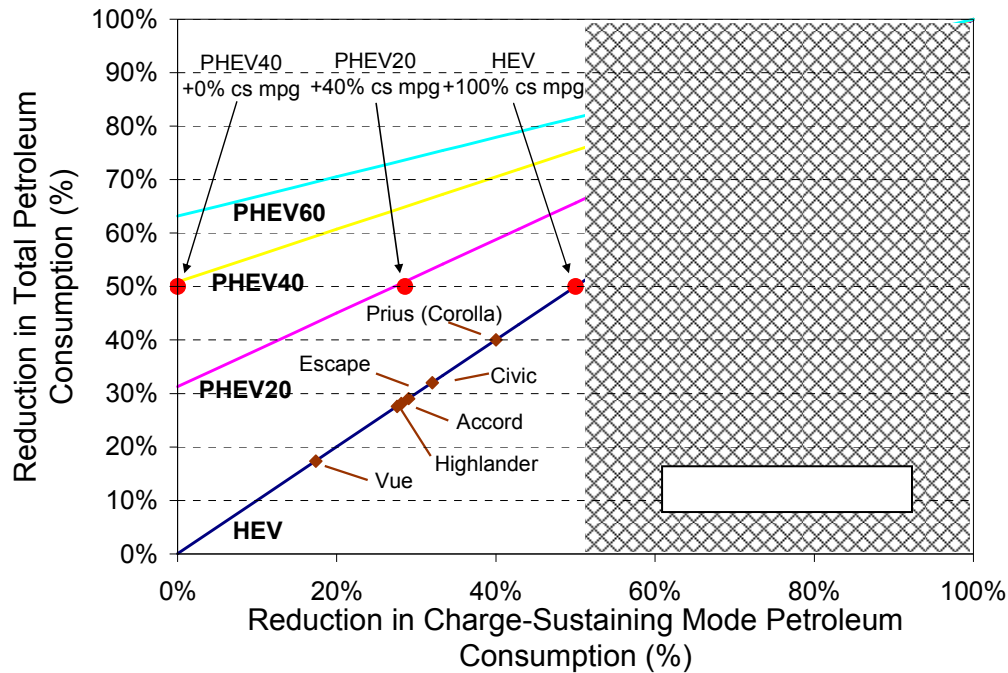

Figure 1: HEV and PHEV Fuel Consumption Benefits by Operating Mode

consumed 30% less petroleum in charge-sustaining mode would also consume 50% less total petroleum. An HEV would have to achieve 50% reduction in consumption in its charge-sustaining mode to have an equivalent total benefit. It is unlikely that the consumption reduction in charge-sustaining mode can be reduced beyond 50% cost effectively. Quantifying the relative costs of adding electric range capability versus improving charge-sustaining mode efficiency is important. Moving vertically in the figure at a given charge-sustaining mode consumption level results in more miles driven electrically. Electrification of miles through charge-depleting operation in a PHEV is expected to be a cost-effective way to continue to reduce fuel consumption beyond HEV technology capabilities.

The conclusions drawn from Figure 1 are based on national driving statistics shown in Figure 2. Figure 2 is a histogram showing the daily driving distance distribution and the resulting utility factor derived from the 1995 National Personal Transportation Survey (NPTS) data. The utility factor represents the fraction of total daily VMT that are less than or equal to the said distance. The utility factor is important for PHEVs because it can be used to effectively weight the value of the charge-depleting fuel consumption benefits versus the charge-sustaining fuel consumption benefits in

a way that allows the results to be extrapolated and applied to the national fleet.

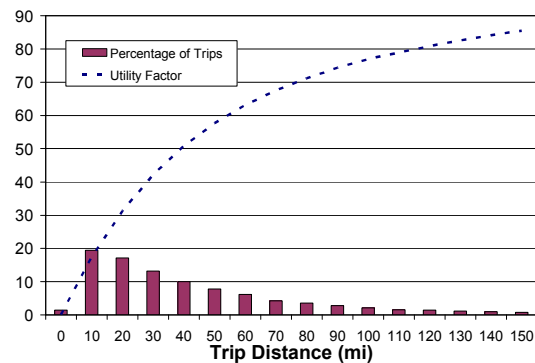

Figure 2: 1995 NPTS Data on Daily Driving Distance Distribution and Resulting Utility Factor

PHEVs take advantage of the fact that the typical daily driving distance is on the order of 30 miles. If most of these miles could be driven electrically, a large portion of our petroleum consumption would be eliminated.

### Design Options and Implications

Determination of the energy storage system characteristics is a critical step in the PHEV design process. The energy storage system design variables include the power, energy, and usable state-of-charge (SOC) window. These three



variables will affect cost, mass, volume, life, fuel economy, and vehicle operation.

The usable energy capacity of the energy storage system is defined by the desired electric range capability. The fuel displacement potential is directly related to the electric range capability. From Figure 2, a range capability of 20 miles (i.e., a PHEV20) would substitute electrical energy for petroleum consumption in 30% of total VMT. Likewise, a PHEV with 40 miles of range capability could displace 50% of total VMT. A typical midsize sedan will require ~300 Wh/mi for all electric operation. Thus a PHEV20 would require ~6 kWh, and a PHEV40 would require ~12 kWh of usable energy. It is possible to reduce the usable energy requirement through aerodynamic and lightweight vehicle designs but not substantially.

For design purposes, the usable SOC window relates the total energy capacity to the required usable energy capacity. A PHEV is likely to incur at least one deep discharge cycle per day and as a result will need to provide 4000+ deep discharge cycles in its 10-15 year lifetime. Figure 3 is a curve-fit to data presented by Rosenkranz showing the expected cycle life performance of lithium-ion (Li-ion) and nickel-metal hydride (NiMH) technology as a function of the discharge depth.[5] It shows that when a battery is discharged more deeply, the cycle life decreases. The horizontal, shaded box is the typical depth of discharge cycling that HEV batteries today incur while the vertical, shaded box is the range of cycles that a PHEV battery will need to endure for a 10-15 year vehicle life.

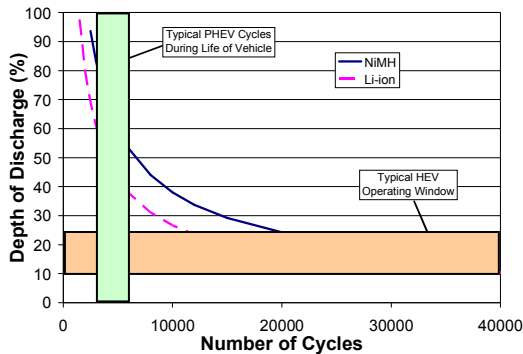

Figure 3: Cycle Life Characteristics of Varta Energy Storage Technologies [5]

The data indicate that NiMH can achieve 4000 cycles when discharged to 70% depth of discharge repeatedly. To achieve the same number of cycles, Li-ion technology could only be discharged to

50% depth of discharge on a daily basis. Assuming a 70% usable SOC window for a PHEV20 then requires 8.6 kWh of total energy capacity. This battery would have 5-10 times more energy capacity relative to that found in current hybrid vehicles. The PHEV40 will need 17.2 kWh. To minimize total energy storage capacity (and thus cost and volume), it will be important to maximize the usable SOC window for PHEVs while satisfying cycle life requirements.

The energy storage system cost, mass, and volume are strong functions of the energy storage system power to energy ratio. Representative specific power and power densities are provided for both Li-ion (based on Saft products [6]) and NiMH (based on Cobasys products [7]) technologies in Figures 4 and 5. Current and projected specific cost relationships are provided in Figure 6. The cost projections are those suggested by Electric Power Research Institute.[8] For fixed energy storage capacity, as power to energy ratio decreases so do cost, volume, and mass. The question is how does reducing the power capability affect the fuel consumption reduction potential?

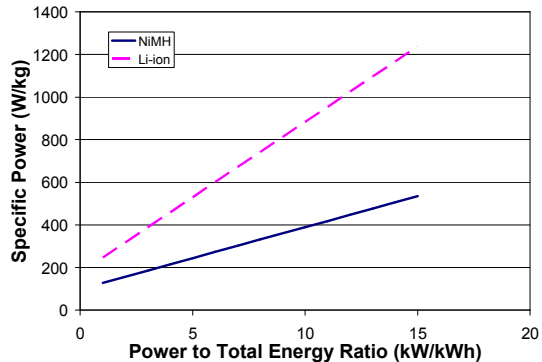

Figure 4: Typical Specific Power of Energy Storage Technologies

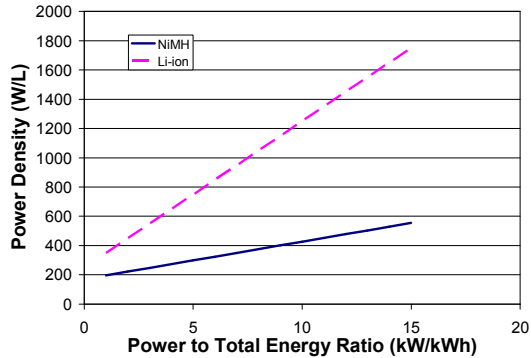

Figure 5: Typical Power Density of Energy Storage Technologies

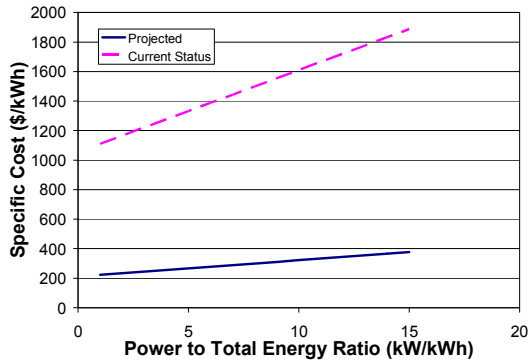

Figure 6: Typical Specific Cost of Energy Storage Technologies

To achieve a desired all-electric range (AER) capability, the energy storage system and motor will need to provide sufficient power to propel the vehicle without assistance from the engine. On an urban driving profile, the peak power is ~40 kW and the power is typically less than 15 kW as shown in Figure 7 for a typical light-duty vehicle.

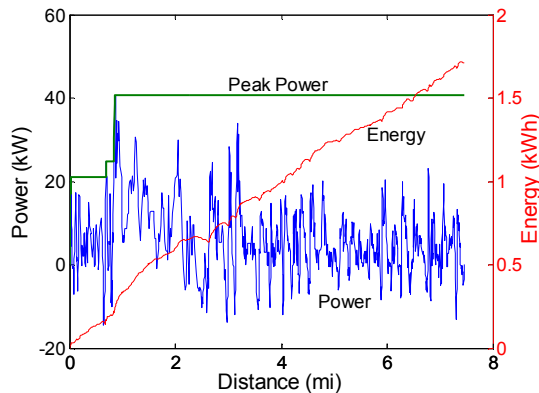

Figure 7: Power and Energy Requirements for All-Electric Range Capability on Urban Driving

In Figures 8 and 9, the power and energy required for all-electric range capability on several driving profiles is provided. The Urban Dynamometer Driving Schedule (UDDS) and Highway Fuel Economy Test (HWFET) cycles are used by the U.S. Environmental Protection Agency to represent urban and highway driving behaviors in reporting the fuel economies of today's vehicles. The Unified Driving Cycle, also called LA92, and the US06 (part of the Supplemental Federal Test Procedure) are more aggressive urban and highway driving cycles respectively that are likely to be more representative of current driving behaviors. The energy to provide 20 miles of all-electric range on the UDDS and HWFET cycles only provides 10 and 15 miles of range capability on the US06 and LA92 cycles, respectively as

shown by the dashed line in Figure 9. A PHEV on the UDDS would need 40 kW of battery power while it would require more than 60 kW on the LA92 cycle. Adding battery power beyond the peak power requirement is unlikely to provide additional value. Acceleration requirements will place additional constraints on the energy storage system power requirements depending on engine sizing.

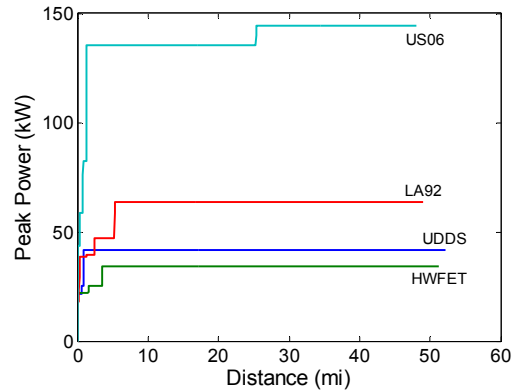

Figure 8: Peak Power Requirements for All-Electric Range Capability for Typical Mid-size Car on Several Duty Cycles

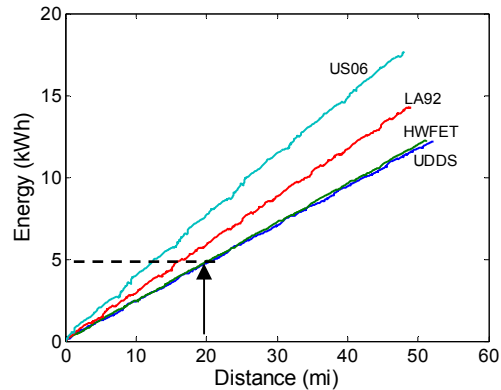

Figure 9: Usable Energy Requirements for All-Electric Range Capability on Typical Driving Profiles for a Mid-size Car

To maximize charge-sustaining fuel economy, it is desirable to minimize the power rating (downsize) the engine as much as possible. The engine in a PHEV will likely be sized to provide continuous performance capability. If it is assumed that the vehicle must achieve a continuous top speed of 110 mph and continuous gradeability at 55 mph on a 7.2% grade using 2/3 of peak engine power then the minimum engine would need to be 80-85 kW for a typical sedan. Now to achieve a 0-60 mph acceleration time of 8.0s or less, the energy storage system would need at least 45-50 kW of power capability at the low SOC operating point. As a

result, with maximum engine downsizing, the power to energy ratio would be  $\sim 5$  for a PHEV20 and 2.8 for a PHEV40.

The sizes described so far are only necessary to achieve large all-electric range capabilities. Significant fuel can be displaced without large all-electric range capability. As shown in Figure 7, the urban drive cycle power requirements are typically less than 15 kW. Since cost, mass, and volume of the energy storage system can be reduced by reducing the power to energy ratio, it is worthwhile to explore the fuel displacement potential of low power energy storage systems for PHEVs.

The lower bound on the energy storage power will be a function of the lowest power to energy ratio modules available. The lowest power to energy ratio for typical Li-ion or NiMH technology today is  $\sim 1$ . Therefore, the minimum power will be on the order of 10-15 kW.

Employing the low-power option limits the all-electric range capability of the vehicle. However, if, when the engine is on, it only provides supplemental power beyond the capabilities of the energy storage system; substantial fuel displacement can still be achieved via a strategy where energy storage and engine operate in a blended manner. The blended approach was proposed in an early paper [9] and will be referred to as a blended strategy in the remainder of the paper.

Figures 10 and 11 provide a comparison between operating characteristics for PHEVs with all-electric-range-focused versus blended operating strategies. In Figure 10, the battery and motor (dashed line) have sufficient power to propel the vehicle until about 22 miles at which time the engine (solid line) is turned on. In Figure 11, the engine turns on within the first mile but when on, it only provides supplemental power, and the battery still provides most of the power. Thus, the battery discharges over approximately the same distance and displaces nearly as much fuel.

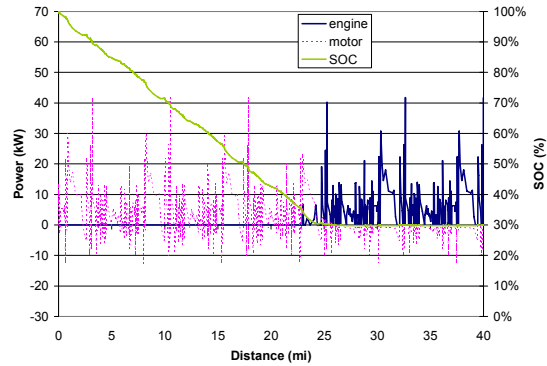

Figure 10: Urban Cycle Operating Characteristics of an All-Electric Range Focused PHEV20

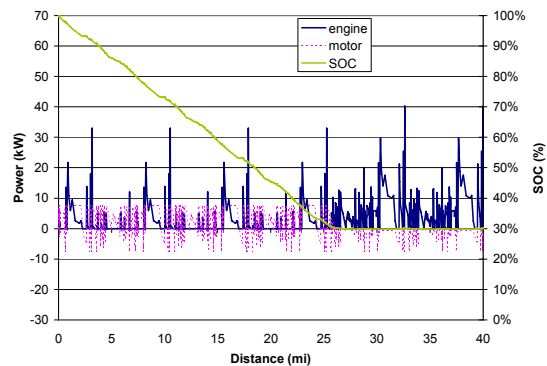

Figure 11: Urban Cycle Operating Characteristics of a PHEV20 with a Blended Strategy

The charts that follow summarize the tradeoffs of power, energy, SOC window, and operating strategy on the cost, efficiency, and fuel savings potential of a PHEV20 and a PHEV40. All components in each vehicle scenario were sized first for an all-electric range scenario and second for a blended scenario. And for each of these four scenarios, a 50% SOC window and a 70% usable SOC window were considered. To define the blended scenario, a power to energy ratio was chosen that was half that of the all-electric range scenario.

Figure 12 summarizes the energy storage system power and energy characteristics of the eight vehicles considered. The SOC window only slightly impacts the power requirement while the AER case needs twice as much power as the blended case as designed. Battery energy is slightly more than a factor of two due to mass compounding.

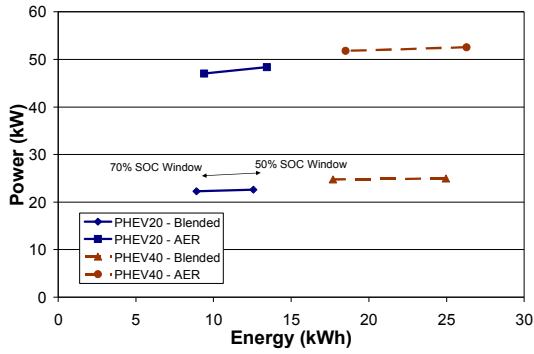

Figure 12: Power and Total Energy Characteristics of the Energy Storage System

Incremental cost of the vehicle is likely to be a significant barrier to PHEV technology acceptance. The main reason for trying to use a lower power to energy ratio energy storage system would be to reduce cost while providing the same amount of energy. Figure 13 shows that reducing power to energy ratio and moving from an AER to blended strategy reduced incremental cost. However, increasing the usable SOC window seemed to more strongly impact the incremental costs.

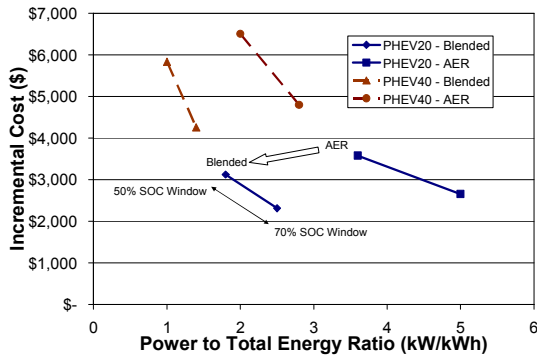

Figure 13: Relationship between Incremental Cost and Power to Energy Ratio

For a given range (e.g., PHEV20) and SOC window (e.g., 50%), moving to a lower power to energy ratio not only reduced the incremental cost but also reduced the fuel consumption reduction potential as expected. The fuel consumption benefits of the blended strategy are about 6% less than the AER strategy for both PHEV20 and PHEV40 cases as shown in Figure 14. Interestingly, expanding the usable SOC window has minimal impact on fuel consumption reduction potential but substantially reduces incremental cost and thus should be emphasized.

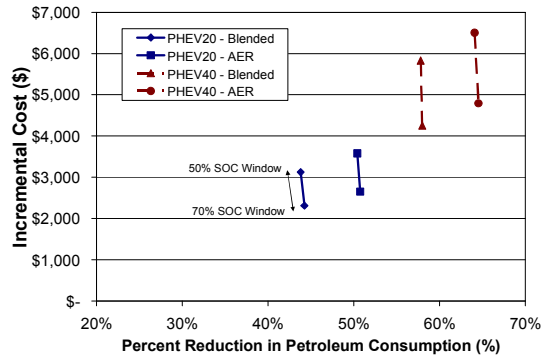

Figure 14: Cost-to-Benefit Relationship for PHEVs

As shown in Figure 15, there are efficiency tradeoffs between a blended and an all-electric range focused strategy. In the AER approach, the engine is as small as possible and when it is on, it will operate at higher load fractions which typically correlate to higher efficiencies. The energy storage system in the AER scenario is a higher power to energy ratio with lower internal resistance and thus less loss. On the other hand, the motor in the blended approach is smaller, and thus running at higher load fractions with higher efficiencies.

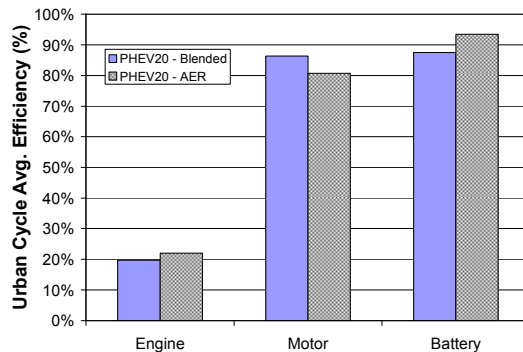

Figure 15: Component Efficiencies for AER and Blended PHEV Strategies

The purpose of these case scenarios is to demonstrate that there are many options in the design of a PHEV. Each of these options has associated tradeoffs. Ideally, the design should find a balance between petroleum consumption reduction potential and incremental costs if it is to be successful. Our results demonstrate that a blended approach combined with an expanded SOC window effectively reduced cost while displacing nearly as much fuel in comparison to an all-electric range focused PHEV. These cost reductions are critical for market viability.

## Analysis Refinements

This analysis provides only a simplified view of the PHEV design space and challenges. There are many uncertainties associated with these conclusions. In particular, there is uncertainty associated with the life cycle data, the battery cost data, and the vehicle usage patterns. It will be important to identify how each of these uncertainties will affect the PHEV design and operation.

The life cycle data available at this time have been collected as constant discharge cycles to a specified depth of discharge repeatedly. The batteries in HEVs today can be expected to encounter tens of thousands of small depth of discharge cycles at a moderate to high SOC. PHEVs will on the other hand encounter at least one deep discharge cycle on a daily basis. In addition, a fully utilized energy storage system will also encounter shallow depth of discharge cycles both at high and low SOC levels. It has been assumed that the daily deep discharge cycle will be the overriding factor that will determine life cycle performance. It is unclear how the shallow cycling behavior may contribute to the degradation of the energy storage system.

Today, the cost of hybrid battery technology is high, and tax incentives are used to make hybrids cost competitive with comparable vehicle options. The energy storage system costs contributing to the incremental cost analysis presented earlier assume future high-volume production. Current costs are estimated to be 4-5 times higher than the long-term assumptions. Since this is a pivotal assumption, it is possible to turn the analysis around and look at what battery costs might need to be to provide a cost effective vehicle.

Figure 16, shows the specific costs that the energy storage technology would need to achieve for the fuel cost savings over 5 years to offset the initial incremental cost. The chart includes both a present fuel cost (\$2.15/gallon gasoline and 9 ¢/kWh electricity case) and a future fuel cost scenario (\$4.30/gallon and 9 ¢/kWh). At today's fuel costs, to be cost neutral, PHEV20 batteries would need to be at the projected long-term cost goals (labeled as Projected Battery Costs in Figure 16). However, in the future fuel price scenario, both PHEV20 and PHEV40 energy storage systems only need to reach the \$750 to \$500/kWh range to be cost neutral respectively.

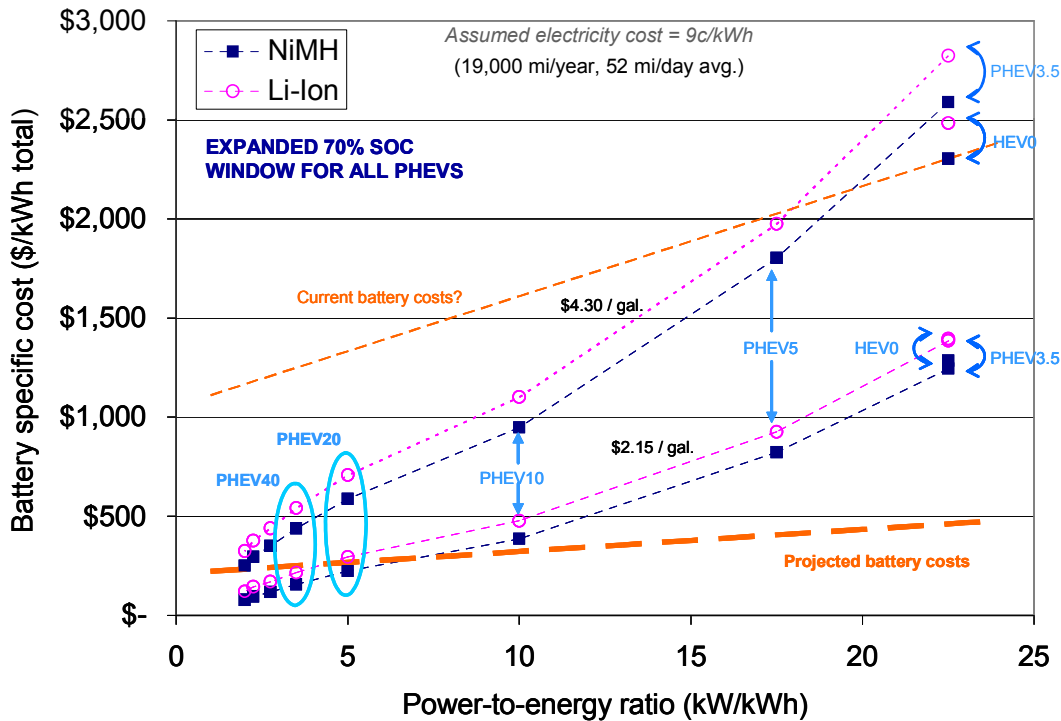

Figure 16: Battery Cost Requirements for Fuel Savings to Offset Incremental Cost within 5 Years

Additional research completed at the National Renewable Energy Laboratory clearly shows that there is a significant connection between the vehicle usage pattern and the consumption reduction benefits of a PHEV both over a conventional vehicle and an HEV. The analysis presented assumes utility factor weighted fuel economies based on the UDDS and HWFET driving profiles. It is fair to assume that neither of these driving profiles (developed in the 1970s) accurately represents typical driving habits of today. In addition, the utility factor is used to weight the relative value of the electric range capability of a PHEV. However, the utility factor is based on data from national personal travel surveys conducted in 1995. More recent data are available and need to be analyzed. It's likely that travel behavior is evolving. In addition, the existing survey data typically only represent a single day of the year and do not account for variation daily or seasonally. PHEV benefits are likely to be significantly influenced by these variations in driving habits.

### Conclusions

PHEVs have the potential to dramatically reduce future U.S. transportation petroleum consumption. To overcome the implementation challenges of PHEV technology, a systems perspective should be employed. This study sheds light on the systems design tradeoffs as they relate to energy storage system technology for PHEVs. Specifically, it evaluates the impacts of reducing power to energy ratio and expanding the usable SOC window on incremental cost and fuel consumption reduction benefits.

Based on the analyses, we conclude that:

- Plug-in hybrids provide potential for reducing petroleum consumption beyond that of HEV technology.
- There is a spectrum of PHEV design options that satisfy performance constraints but with tradeoffs in incremental costs and fuel consumption reduction potential.
- Expansion of the usable SOC window while maintaining energy storage system life will be critical for reducing incremental costs of PHEVs.
- The fuel consumption reduction benefits are only slightly reduced while the battery size and cost are significantly reduced when a blended strategy is chosen relative to an all-electric range focused strategy.

### References

- 1) Energy Information Administration [www.eia.doe.gov](http://www.eia.doe.gov).
- 2) Hirsch, R., Bezdek, R., and Wendling, R. "Peaking of World Oil Production: Impacts, Risks, and Mitigation." February, 2005.
- 3) "Highway Statistics 2004." U.S. Department of Transportation. Federal Highway Administration. <http://www.fhwa.dot.gov/policy/ohim/hs04/index.htm>.
- 4) Davis, S., Diegel, S. "Transportation Energy Databook: Edition 24." December, 2004.
- 5) Rosenkranz, C. "Deep Cycle Batteries for Plug-in Hybrid Application" Presented at *EVS-20 Plug-in Hybrid Workshop*. Nov. 15, 2003. Monaco.
- 6) Saft website. [www.saftbatteries.com](http://www.saftbatteries.com).
- 7) Cobasys website. [www.cobasys.com](http://www.cobasys.com).
- 8) Duval, M. "Advanced Batteries for Electric Drive Vehicles." EPRI Technical Report #1009299. May, 2004.
- 9) Markel, T. and Simpson, A. "Energy Storage Considerations for Grid-Charged Hybrid Electric Vehicles." *IEEE Vehicular Technologies Conference*. September 7-9, 2005. Chicago, IL.

### Acknowledgements

The authors would like to acknowledge the programmatic support of the U.S. Department of Energy Office of Energy Efficiency and Renewable Energy FreedomCAR and Vehicle Technologies Program.

## Section 4.3

**Title:** “Dynamic Programming Applied to Investigate Energy Management Strategies for a Plug-In HEV”

**Type:** Paper

**Authors:** Michael Patrick O’Keefe and Tony Markel

**Date:** October 2006

**Conference or Meeting:** To be published at the 22nd International Battery, Hybrid, and Fuel Cell Electric Vehicle Symposium and Exposition

**Abstract:** Compares the performance of an electric-centric charge-depleting hybrid vehicle control strategy with a near-optimal dynamic programming-optimized control strategy utilizing a priori knowledge of the driving profile

# Dynamic Programming Applied to Investigate Energy Management Strategies for a Plug-In HEV<sup>1</sup>

Michael Patrick O'Keefe  
National Renewable Energy Laboratory

Tony Markel  
National Renewable Energy Laboratory

## Abstract

Plug-in hybrid electric vehicles (PHEVs) are an advanced dual-fuel powertrain technology that combine features of the battery electric vehicle (BEV) and hybrid electric vehicle (HEV). One of the fuels of the PHEV is electricity which is supplemented by another fuel (typically gasoline). The gasoline consumption for a PHEV is distance dependent based on the vehicle control strategy. In this paper, we explore two basic control concepts applied to a PHEV: an “electric vehicle centric” control strategy and an “engine-motor” blended control strategy. A near optimal control solution is derived using the dynamic programming optimization algorithm. Based on comparison with the dynamic programming results, we show that for urban driving, a PHEV should typically operate closer to an “electric vehicle centric” control strategy to provide consistently high fuel savings. We also show that PHEVs with smaller motors and lower power-to-energy ratio batteries can save nearly the same amount of fuel as a full-size PHEV—but perhaps at a reduced cost.

**Keywords:** Plug-In Hybrid, Hybrid Strategy, Energy Efficiency, Modeling, Dynamic Programming

## 1 Introduction

### 1.1 Plug-In Hybrid Electric Vehicles

Plug-in hybrid electric vehicles (PHEVs) are a dual-fuel technology capable of transforming the transportation energy infrastructure away from non-renewable, high-carbon fuels to more environmentally responsible options. One of the PHEV fuels is electricity. The other fuel could be one of any number of options, although gasoline is considered here.

PHEVs can deliver performance equivalent with today's modern vehicles. Furthermore, compared with other technology options, the PHEV does not suffer from some of the infrastructure issues (e.g., fuel cell vehicles) nor the limited range issues (e.g., battery electric vehicles) exhibited by other technologies. These positive benefits are the result of both efficient delivery of fuel-energy from the tank to the wheels and, more importantly, a transition from conventional transportation fuels to electricity. This is possible because PHEVs exhibit aspects of both battery electric vehicles (BEVs) and hybrid-electric vehicles (HEVs):

---

<sup>1</sup> This work has been authored by an employee or employees of the Midwest Research Institute under Contract No. DE-AC36-99GO10337 with the U.S. Department of Energy. The United States Government retains and the publisher, by accepting the article for publication, acknowledges that the United States Government retains a non-exclusive, paid-up, irrevocable, worldwide license to publish or reproduce the published form of this work, or allow others to do so, for United States Government purposes.



- A large energy storage unit capable of being recharged from the electrical utility grid and supplying net motive energy over a significant distance
- A hybrid powertrain typically using an internal combustion engine with an electrical motor

By blending aspects of the BEV with conventional HEVs, one can gain many of the advantages of a BEV while eliminating several disadvantages. Because fewer batteries are needed than a full BEV, the PHEV comes with a reduced cost penalty versus a BEV of equivalent performance. Furthermore, the PHEV has no range penalty and charging times are much shorter than an equivalent BEV. In contrast to an equivalent HEV, fuel consumption is further reduced since fuel energy is supplied from both electricity and liquid fuel as opposed to just liquid fuel as is the case for conventional HEVs.

PHEVs work well for vehicles that operate where relatively short trips comprise the bulk of distance traveled. By recharging between these short trips, a large portion of the motive energy can come from the electrical grid as opposed to gasoline or other fossil fuels. The transition from today's petroleum-based transportation fuels to electricity opens up many opportunities. By recharging the vehicle's batteries overnight, electrical utilities can increase their operating efficiency. Furthermore, due to the difference between peak capacity and base-load capacity, power utilities will typically have enough excess capacity at night to recharge a large number of vehicles before having to add new capacity. If done correctly, this can lead to reductions in carbon dioxide (CO<sub>2</sub>) and other greenhouse gas emissions. Furthermore, if effort is made to transform the power plants within the national electrical grid to use more renewable sources of energy, the benefits of renewable energy can be brought to the transportation sector through PHEVs.

However, PHEVs do have some challenges for commercialization. Chief among these are cost which is largely connected with batteries and battery life, in addition to the added cost of PHEV power electronics and powertrain components.

In this paper, we will explore two separate PHEV architectures. Both vehicles yield equivalent performance and have the same electrical capacity in the vehicle energy storage system. The first, referred to as the full-size PHEV, contains a high-power motor and energy storage unit with smaller internal combustion engine (ICE). The second vehicle, referred to as the half-size PHEV, uses a lower power motor with lower power energy storage and larger ICE. The second vehicle represents a lower-cost PHEV solution because it deemphasizes the (expensive) electric powertrain components such as high-powered batteries and emphasizes ICE technology.

In addition to the vehicle architectures, we also discuss two different PHEV energy management strategies: an "electric vehicle centric" approach and a blended-control approach. In the "electric vehicle centric" approach, the motor and batteries attempt to meet all traction demand electrically, with the engine only helping when the motor is not powerful enough. This strategy uses electricity whenever possible. The blended control approach attempts to spread the electrical consumption over a larger distance by blending engine power with motor usage at times when the system is more efficient.

In order to compare these control paradigms, the dynamic programming algorithm, which can determine the near-optimal solution of any control problem, is used.

## 1.2 The Dynamic Programming Method

Dynamic programming is a numerical technique that can be applied to any problem that requires decisions to be made in stages with the objective of finding a minimal penalty decision pathway [1]. "Penalty" used in this sense refers to a quantitative measure of the undesirable outcomes of a decision. Dynamic programming combines knowledge of the immediate penalty of the decision at hand with knowledge of future penalties that arise as a result of the immediate decision. This algorithm has been applied with success to HEVs in the past [2], though the authors are unaware of any application to PHEVs to date.

Dynamic programming requires the definition of a discrete time dynamic system (DTDS) and a penalty function. Because the dynamic programming algorithm is quite computationally intensive, a fast computational model is desired for the DTDS. In the context of this paper, the DTDS is a vehicle model which calculates the change in state (battery state-of-charge) resulting from a given control setting (the engine shaft out power) over a time-step along a duty cycle. The duty cycle, the vehicle’s commanded speed versus time, is treated as deterministic for this study. The algorithm proceeds from the end of a duty cycle to the beginning, calculating the penalty of possible control settings at each time step. Because knowledge of the duty cycle is required beforehand, the dynamic programming algorithm cannot be implemented in actual control systems in real life. However, outputs from the dynamic programming algorithm can be used to formulate and tune actual controllers.

The penalty function used in this study attributes a penalty for using fuel, not meeting the specified duty cycle speed-time trace, and for not holding end state-of-charge at a reasonable level.

The dynamic programming algorithm as used in this study only explores a subset of the entire design space. Because of this, the control cannot be said to be “optimal,” only “near-optimal”.

There are two main reasons to employ the dynamic programming method in this study:

- To compare PHEV architectures under “near-optimal control”
- To gain insights into what the “optimal” control is for a PHEV under various circumstances.

By comparing all PHEV architectures under an “optimal control,” control itself is eliminated as a design variable from the problem.

## 2 Analysis Overview

This study compares the energy implications for two PHEV architectures over multiple urban duty cycles (driving patterns) and multiple distances using a “near-optimal” control strategy derived via the dynamic programming algorithm. Both vehicles contain enough electrical energy to drive approximately 32 km (5.5 kWh usable capacity). The selection of this capacity and specific sizes is based on a cost benefit analysis of PHEVs conducted by Simpson [3]. Both vehicles in this study use a parallel hybrid design where the engine and/or motor can contribute to tractive effort at any time. Gasoline is assumed for the liquid fuel in this study. However, it is important to note that PHEVs could use other fuels such as diesel, ethanol (E85), or even hydrogen if the ICE is properly designed to handle the given fuel.

### 2.1 Vehicle Platform, Performance, and Assumptions

The vehicle platform used for this study is a mid-size sedan with performance requirements specified so as to be competitive in the North American marketplace. The specific requirements are given below in Table 1.

Table 1: Mid-Size Sedan Performance Requirements and Platform Assumptions

<b>Attribute</b>	<b>Value</b>
<u>Top Speed</u> <i>top speed to be maintained</i>	177 km/hr (110 mph)
<u>Full Acceleration</u> <i>time from 0 km/hr to 96.6 km/hr (60 mph)</i>	8.0 seconds
<u>Passing Acceleration</u> <i>time from 64.4 km/hr (40 mph) to 96.6 mph (60 mph)</i>	5.3 seconds
<u>Hill Climbing</u> <i>grade (percent rise over road-surface run) to climb with engine at 66% of rated power</i>	6.5% grade @ 88.5 km/hr (55 mph)

<u>Range</u> <i>maximum distance traveled starting fully fueled</i>	643.7 km (400 miles)
<u>Glider Mass</u> <i>the mass of the vehicle minus the powertrain</i>	905 kg
<u>Cargo Mass</u> <i>the mass of cargo carried while meeting performance constraints</i>	136 kg
<u>Accessory Loads</u> <i>the accessory loads assumed for the PHEV</i>	0.7 kW electric average 4.0 kW electric peak
<u>Transmission Efficiency</u> <i>efficiency of the mechanical gearing between motor/engine and wheels</i>	85%
<u>Electrical Generation Efficiency for Accessories</u> <i>efficiency of generating the power to electrical accessories</i>	85%

These requirements imply minimum component sizes. The peak accessory loads are assumed to be engaged for purposes of calculating the hill climbing and top speed power requirements. All other calculations (including fuel consumption calculations) assume average accessory loads. The resulting component requirements for a conventional vehicle and two PHEVs are given in Table 2.

Table 2: Component Sizes and Weights Used in Study

<b>Component</b>	<b>Conventional Vehicle</b>	<b>Full-Size PHEV</b>	<b>Half-Size PHEV</b>
Spark Ignited Internal Combustion Engine	121.7 kW peak 238.6 kg	80.1 kW peak 171.3 kg	99.2 kW peak 202.2 kg
Electric Motor and Inverter	NA	44.1 kW peak 45.1 kg	21.4 kW peak 33.0 kg
Battery Pack	NA	5.50 kWh usable 47.2 kW peak 11.8 kWh full capacity 94.4 kg	5.57 kWh usable 23.9 kW 11.9 kWh full capacity 79.6 kg
Gasoline and Tank	509 kWh 49.1 kg	396 kWh 38.2 kg	416.7 kWh 40.2 kg
Transmission	167.9 kg	176.0 kg	176.8 kg
Support Structure	68.3 kg	78.8 kg	79.8 kg
Glider Mass	905.0 kg	905.0 kg	905.0 kg
Cargo Mass	136.0 kg	136.0 kg	136.0 kg
<b>Total Vehicle Mass</b>	<b>1428.9 kg</b>	<b>1508.8 kg</b>	<b>1516.6 kg</b>
<b>Tested Mass</b>	<b>1564.9 kg</b>	<b>1644.8 kg</b>	<b>1652.6 kg</b>
<b>Degree of Hybridization</b>	<b>0%</b>	<b>35.51%</b>	<b>17.75%</b>

There are some subtleties in Table 2 that should be pointed out. First, note that advanced battery specifications are assumed. Next, the type of battery used in the full size PHEV is different from that used in the half-size PHEV. If one examines both batteries, you will quickly see that the usable capacity of both packs is nearly the same (the slight difference is due to the difference in weight and requirement for both vehicles to drive the same range). However, the weights of both packs and the pack powers are different. This arises from a difference in battery pack power-to-energy ratio. The energy density of batteries differs by power to energy ratio. Low power-to-energy ratio batteries also tend to be slightly less expensive as a technology. For more detail on how cost and weight of each component interact with vehicle requirements, see the paper by Simpson [3].

The degree of hybridization of both PHEVs appears in Table 2. This percentage is the ratio of the motor power to the engine plus motor power. The degree of hybridization of the “half-size” PHEV is half that of the full-size PHEV, hence the name.

## 2.2 Vehicle Model

The vehicle model is used as the discrete time dynamic system (DTDS) by the dynamic programming algorithm. The model takes in a single control setting for each time step—the desired ICE shaft-out power for that time step. Based on the ICE shaft output power, the motor will either accept or transmit power so as to satisfy the tractive effort and accessory loads required for the given time step. The model also contains state information. The only state variable is the battery state-of-charge at the beginning of a time step. Based on the tractive effort required during the time step (defined by the duty cycle) and the control setting for ICE power, the battery state-of-charge will change.

Because the dynamic programming method is computationally expensive (requiring many model evaluations), the vehicle model used in this study has been constructed to contain only the minimum required detail so as to be quick. For example, components in the powertrain use models of power and efficiency as opposed to torque, speed, and efficiency.

A schematic of the powertrain layout and a listing of component efficiencies by output power are given for the ICE and motor/inverter components of the full-size and half-size vehicles in Figure 1.

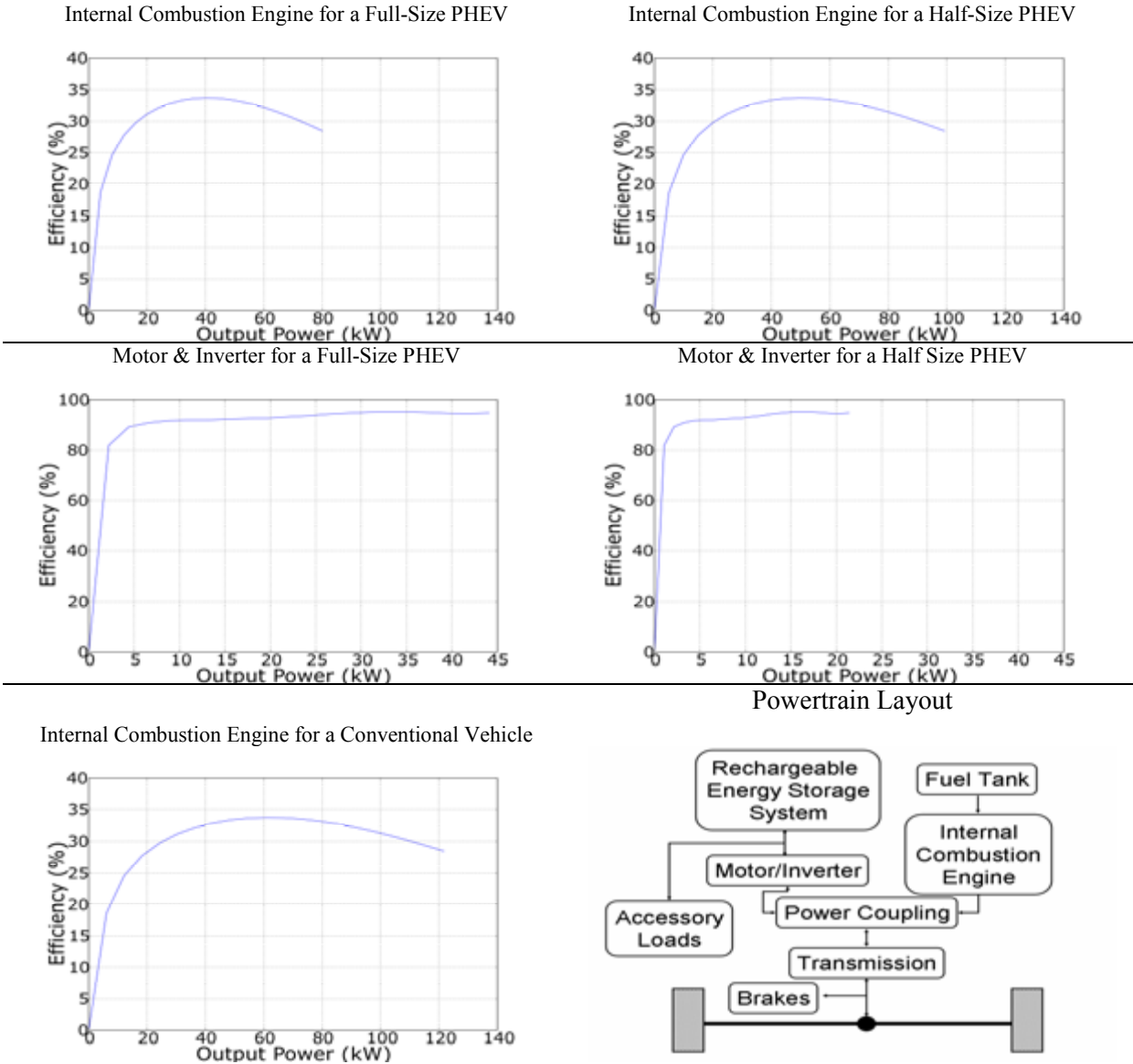

Figure 1: Component Efficiency Maps by Shaft Output Power and Powertrain Layout

The model is written in an open-source object oriented programming language called Python and uses the following open source modules: Numeric Python, Scientific Python, and Matplotlib [4, 5, 6]. The model does not at this time include details related to engine start-stop (i.e., durability constraints, vibration, emissions considerations).

### 2.2 Duty Cycles Examined

The scope of this study is limited to urban driving. Two cycles, the Urban Dynamometer Driving Schedule (UDDS) and the Los Angeles 1992 (LA92) cycle are used to represent aggressive and passive urban driving. A simplification of the UDDS cycle has been substituted for the real UDDS in the interest of simulation time. The simplified UDDS cycle approximates the full UDDS using fewer time-steps, which aids in speeding up the dynamic programming algorithm. This is a great time saver during dynamic programming runs using higher design space resolution. Graphs of the time-speed traces appear below in Figure 2.

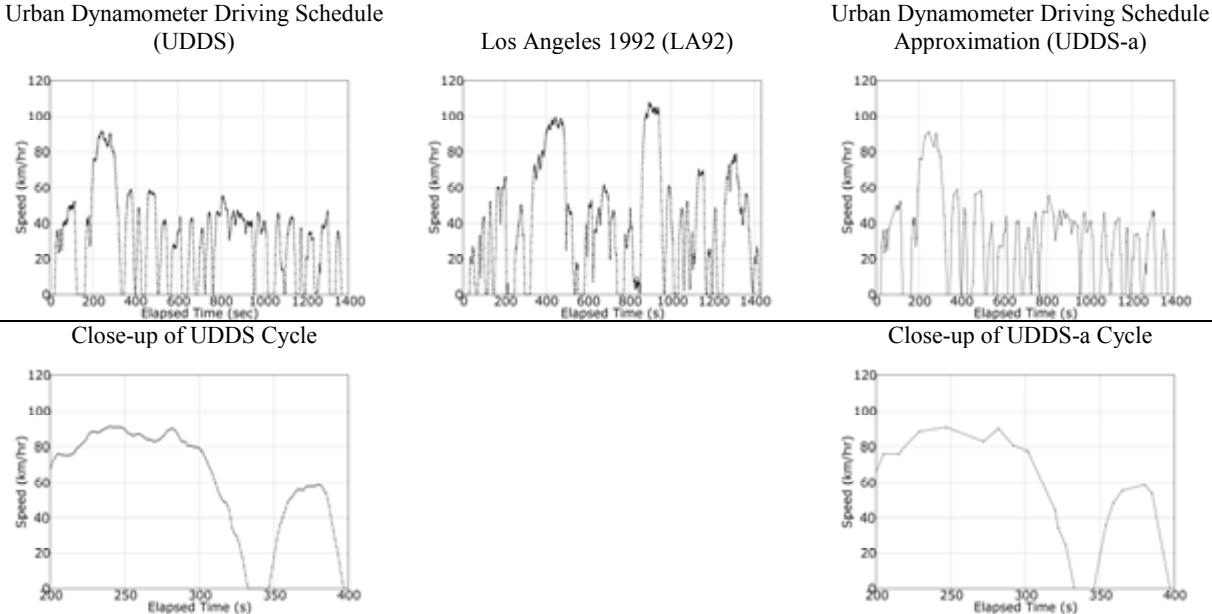

Figure 2: Drive Cycles Used in this Study

### 3 Analysis Results

The gasoline fuel consumption predicted by the models over the LA92 and UDDS-a cycles is given below in Table 3. A lower heating value of 32 MJ/liter of gasoline is assumed. The values given for fuel economy for this mid-size sedan are reasonable for the North American market. The charge sustaining fuel consumption numbers for the PHEVs represent a best case scenario for hybrid fuel savings. Fuel savings from the PHEV relative to the conventional vehicle arise from three main sources: regenerative braking, engine-off operation for the PHEVs, and more efficient operation of the internal combustion engine by supplementing with the traction motor and battery system.

Table 3: Gasoline Fuel Consumption for Conventional Vehicle and Charge Sustaining PHEVs

CYCLE	Conventional Vehicle	Full-Size PHEV charge sustaining	Half-Size PHEV charge sustaining
LA92	3512 J/m 10.98 L/100 km 21.43 mpg	1789 J/m 5.59 L/100 km 42.07 mpg	1862 J/m 5.82 L/100 km 40.42 mpg
UDDS-a	3508 J/m 10.96 L/100 km 21.46 mpg	1535 J/m 4.80 L/100 km 49.03 mpg	1522 J/m 4.76 L/100 km 49.45 mpg

Highway Federal Emissions Test (US EPA)	2199 J/m 6.87 L/100 km 34.23 mpg	NA	NA
---	--	----	----

In Table 3, the values given for the highway federal emissions test (US EPA) are for the conventional vehicle only and are used here to aid the reader in gaining a feel for the range of fuel consumption.

Figure 3 shows two of the output graphs resulting from the dynamic programming algorithm being applied to the PHEV models. Here, the (near-) optimal engine command is shown versus the tractive effort required between the tires and the wheel. This power measured at the tire-road interface is referred to as the “roadload.” Two cycles are run in Figure 3: five UDDS-a cycles to the left (29.4 miles/47.3 km) and four LA92 aggressive urban driving cycles (39.3 miles/63.2 km) to the right.

The engine is not producing power (zero load) for a large portion of the duration of both cycles. When the engine is transmitting power, it appears to be supplementing the traction motor as evidenced by operating commands falling below the line  $y=x/0.85$ , where  $y$  is the engine command and  $x$  is the roadload (i.e., relating roadload to power at the engine shaft via the constant transmission efficiency of Table 1). This engine operation chosen by dynamic programming is a rather complex blending algorithm that minimizes fuel consumption within the constraints given.

We quickly see that duty cycle does make a difference when we contrast the results of the dynamic programming algorithm run over the UDDS-a with those of the LA-92 cycle (Figure 3). Due to the repetition and simplification of the UDDS-a, there is not as much point scatter. We do see similar trends of increased engine usage with roadload. However, we do not see the same amount of point scatter at low engine commands and low roadload as we do for the LA-92.

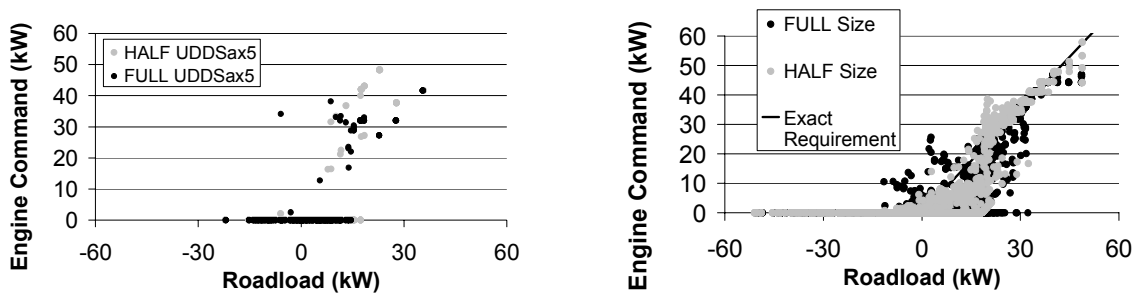

**Figure 3: Engine Command versus Roadload over UDDS-a x5 and LA92 x4**

The engine commands versus time for the full-PHEV over five UDDS-a cycles and five LA92 cycles appear in Figure 4. There are some similarities in the approaches taken by the dynamic programming algorithm in both cases. First we see a strong emphasis on engine commands in the 20-kW to 40-kW region repeating each cycle iteration (i.e., five times over the five cycle sequence). This is a sensible approach. If it is known ahead of time that engine power must be used to supplement the electric capacity of the ESS, it is best to use the engine when the engine is most efficient. As can be seen from Figure 1, the engine is most effective when at higher power loadings (peak efficiency between 30-50 kW).

Another way to help understand more in-depth what the dynamic programming algorithm is doing is to examine the energy storage system state-of-charge or capacity versus distance. These data inform us of how the battery system is being drawn down—aggressively discharged or at a reduced discharge rate (due to a blending of battery energy with engine power).

Figure 5 (left) shows the energy storage system discharge over three dynamic programming runs: a run of one UDDS-a cycle, a run of three UDDS-a cycles, and a run of five UDDS-a cycles. The full-size PHEV is used on all of the runs. Note that before the vehicle reaches the “electric vehicle centric” range of about 40 km (for the UDDS), the drawdown is completely along an “electric dominant”

drawdown path. As distance increases over this “electric vehicle centric” drawdown path, the slope of discharge with distance decreases (i.e., a longer distance is required to discharge the same amount of battery energy). Minimum gasoline consumption is obtained by spreading the battery energy out over the entire distance of the cycle (such that the desired end state-of-charge is reached when the desired range is reached).

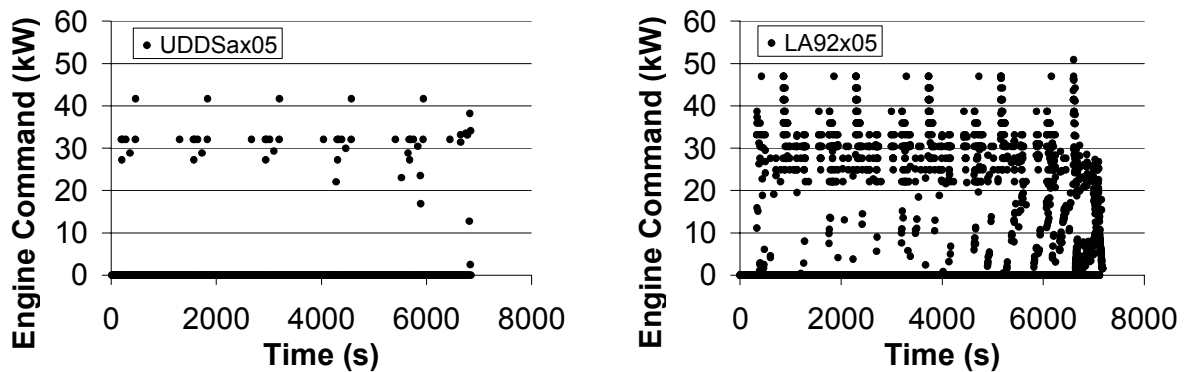

Figure 4: Engine Commands for the UDDS-a and LA92 by Time

The right-hand side of Figure 5 shows the same state-of-charge curve for the LA-92 cycle. This time, the PHEV simulations optimized by dynamic programming over 1 through 5 cycles are shown. In addition, a charge sustaining (CS) run over one LA-92 distance and a run over five LA-92 cycles where the vehicle first has an “electric vehicle centric” discharge followed by charge sustaining operation are shown. In the “electric vehicle centric” case (FULLx05 EV followed by CS operation), the vehicle discharges its electrical energy as fast as possible and then goes into charge sustaining operation. This case provides an interesting contrast to the dynamic programming run over the same distance (FULLx05).

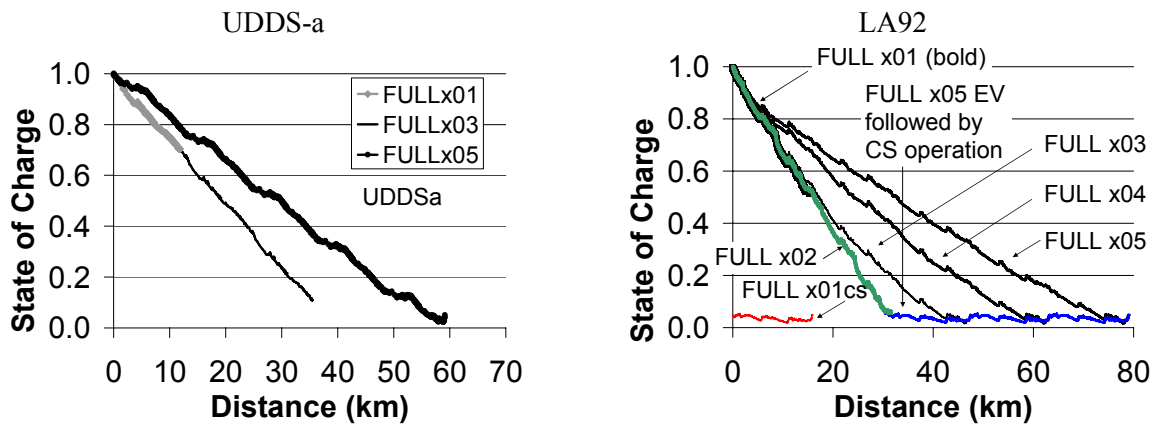

Figure 5: SOC by Distance over UDDS-a and LA92 cycles

In the right-hand-side of Figure 5, for the first couple of LA92 cycles, the vehicle has not yet reached its “all-electric range”. As such, the PHEV can operate in an “electric vehicle centric” mode relying almost exclusively on battery energy. For distances below the “all-electric range”, the dynamic programming algorithm operates the PHEV with an “electric vehicle centric” discharge where possible because this type of operation minimizes gasoline consumption. When the vehicle is asked to operate beyond a range that can be supplied exclusively by battery energy (i.e., beyond the all-electric range), the dynamic programming algorithm blends engine operation with battery discharge to minimize gasoline usage while still driving the requested distance.

In contrast to the dynamic programming strategies for distances above the “all-electric range”, the “electric vehicle centric” strategy draws down as fast as possible and then goes into a charge

sustaining mode. Note that charge sustaining operation is around 5% of full (usable) SOC. The results in Figure 5 were exclusively for the “full-sized” PHEV. Let us examine the effect that component sizing and powertrain architecture can have on consumption rates.

Figure 6 shows the consumption rates of gasoline and electricity for the full-size and half-size PHEVs over repeats of the UDDS-a and LA92 cycles. The values for electricity consumption for both full and half-size architectures are quite similar after all-electric range is exceeded (around 40 km on the UDDS-a). This is because both vehicles discharge all of their capacity (albeit in different ways) over the same distance. Electricity consumption also begins to decrease after all-electric range is exceeded. This is because a fixed electrical capacity is being spread out over longer and longer distances. In contrast, gasoline consumption increases after exceeding all-electric range. Note that the full-size PHEV does not require gasoline at any point below its all-electric range for the UDDS-a cycle. On that same UDDS-a cycle, full-size gasoline consumption rates exceed half-size PHEV gasoline consumption rates at higher distances. This is not the case under more aggressive driving such as what is seen on the LA92. The UDDS-a results are due to the smaller motor in the half-size PHEV being better utilized and thus more efficient. Note that fuel consumption rates are not very different between the full and half-size PHEVs for most distances. Full-size and half-size electricity consumption rates are nearly identical after all-electric range is met. The largest disparity is under aggressive urban driving prior to all-electric range being met. However, in terms of absolute fuel usage, the fuel usage of the half-size PHEV is still only about 1/9<sup>th</sup> the consumption rate of a conventional vehicle over the same cycle.

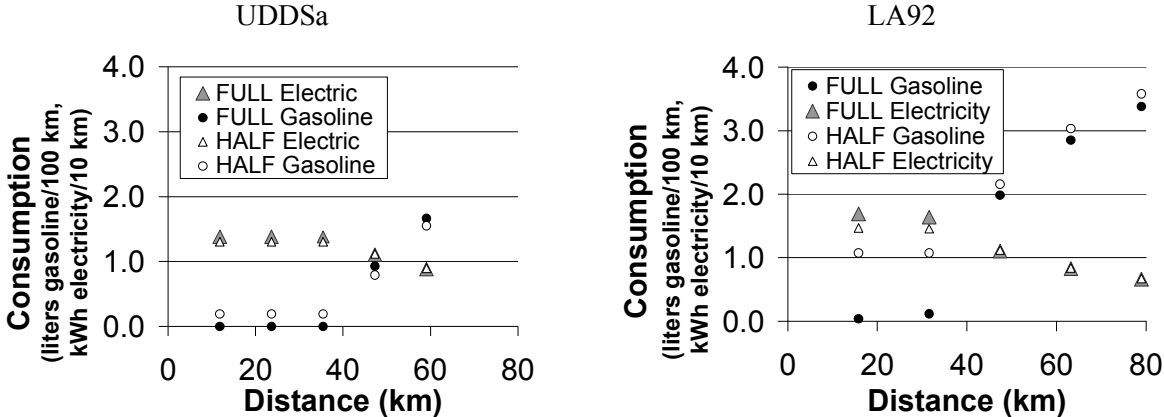

Figure 6: Fuel Consumptions of PHEVs over UDDS-a and LA92 Cycles

Figure 7 shows us one of the key areas of impact for PHEV technology—gasoline fuel usage by distance. The set of graphics in Figure 7 are run for the half and full-size PHEV vehicle over the UDDS-a (mild urban driving) cycle. Each curve on the figure is the result of a dynamic programming run optimized for the given distance. That is, for example, the curve labeled “HALFx3” is the fuel consumption minimized by the dynamic programming algorithm to have the lowest net fuel consumption after 3 UDDSa cycles back-to-back. This distance aspect is key to understanding what is going on with the dynamic programming control of PHEVs. In this case, the dynamic programming algorithm has *a priori* knowledge of the cycle and distance to be run and shows us the optimum control under that circumstance. For distances above the “all-electric range,” the operation is a “blending strategy” that blends engine usage with motor usage so as to minimize fuel consumption while meeting the drive cycle trace. This blending is in addition to that required due to component size limitations such as when an acceleration event requires more power than the traction motor can handle in isolation and thus the engine assists.



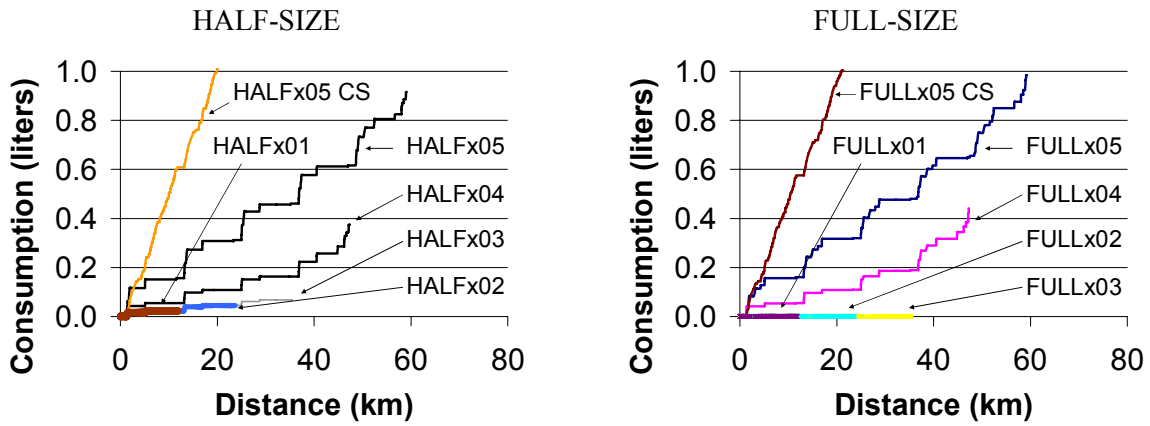

Figure 7: Gasoline Consumption of Half and Full-Size PHEVs over UDDS-a Cycles

What is key to note here is that for both the half and full-size PHEVs, a fuel consumption optimally blended to have minimum fuel consumption at a given target distance does not necessarily have the minimum consumption at other distances. Figure 8 further expands upon this point by displaying gasoline consumption results for the LA92 contrasted with an “electric vehicle centric” control strategy. All runs change to charge sustaining operation after reaching their target distances. The charge sustaining control is optimized by dynamic programming to minimize fuel.

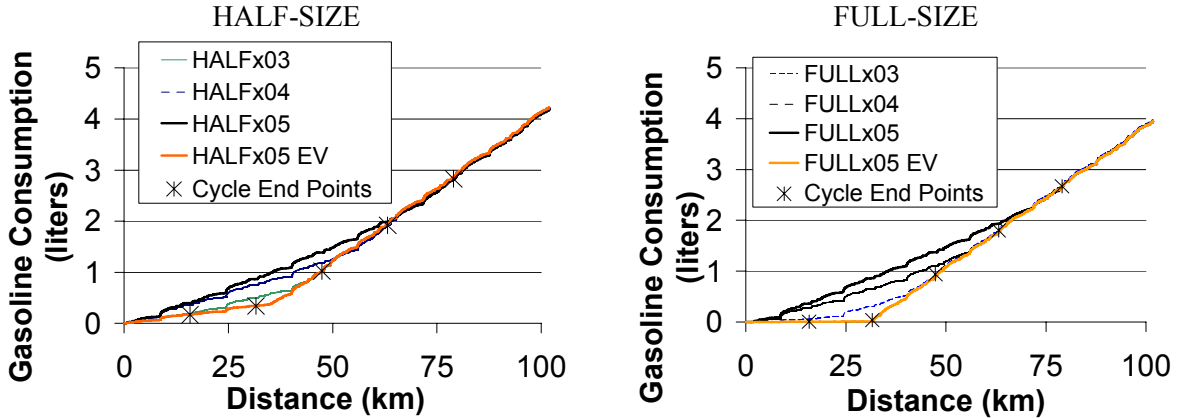

Figure 8: Gasoline Consumption over LA92 for Half- and Full-Size PHEV

Figure 8 shows the results of dynamic programming runs applied to multiple distances of the LA92 driving cycle. The designation “FULLxN” refers to the full-size PHEV optimized by dynamic programming to run for a number of LA92 cycles equal to N. Dynamic programming for N cycles operates the vehicle to have near minimum fuel consumption for the given distance.

Figure 8 also contains the results of the PHEV run in an “electric vehicle centric” mode (labeled “EV” in the figure) where the engine is commanded to be off unless doing so would cause the vehicle to not meet the cycle speed-time trace. Thus, simply put, “use electricity to power the vehicle if at all possible and supplement with the engine if the motor does not have enough power to meet the cycle speed-time trace.” When the vehicle has run its target distance, the PHEV begins to run in charge sustaining mode. That is, the PHEV begins to run similar to a conventional HEV where no significant net discharge of the energy storage system occurs over time or distance. This can be seen clearly for the “FULLx03” case where the vehicle has one of the lowest energy consumptions of the “blended” modes until one LA92 distance and then changes over to charge sustaining mode.

As can be seen from Figure 8, gasoline fuel consumption for the “electric vehicle centric” control is nearly equivalent in all cases to the dynamic programming control set to minimize fuel consumption over a specific distance. This is because we are continually running the same cycle back-to-back and thus it doesn’t matter if one uses the electrical energy all at once at the beginning or spread out

throughout the cycle. The equivalency between strategies would not necessarily be the case for varied driving patterns though the effect of driving pattern variation has not been examined in this study.

Now, let us consider these dynamic programming results in the context of what can be practically implemented in real life. There are two general strategies that have been presented: a “blended” engine/motor strategy and an “electric vehicle centric” strategy. The “blended” mode is what the dynamic programming algorithm optimized to give minimum fuel usage for a given distance most closely resembles. The engine is run at the most opportune times to minimize fuel consumption. In the “electric vehicle centric” strategy, focus is given to supplying transportation energy with electricity and the engine is only used when necessary to meet vehicle performance constraints.

Note that for distances below the PHEV’s electric range, the dynamic programming algorithm chooses an “electric vehicle centric” strategy as this minimizes fuel usage for any range below the electric range. That is, if we know we will be running less than the all-electric range of the vehicle, the “electric vehicle centric” strategy is near optimal. For distances longer than the PHEV’s electric range, a blended strategy is chosen by dynamic programming. However, let us consider the “cost of being wrong” in terms of choosing a control strategy for trip distances above the electric range of the vehicle. Figure 8 shows us that a vehicle with a “blended” strategy optimized for an intended 80 km of intense urban driving would use more fuel than the “electric vehicle centric” strategy all the way up to above 70 km of driving distance. It should be noted that the “electric vehicle centric” control strategy benefits from a charge sustaining control optimized by dynamic programming. However, so does the actual blending mode control. Thus, even if we imagine adjusting the fuel consumption rates upwards during both blended charge depleting operation and charge sustaining operation, the point is still clear: a vehicle operating in blended mode that deviates from the target distance uses more fuel than a vehicle using an “electric vehicle centric” approach. Therefore, the “electric vehicle centric” mode is essentially the optimal fuel consumption case over most of the distance. In contrast, the “blended” mode is optimal for specific distances but non-optimal for others.

## 4 Conclusions

This study shows that a half-size PHEV using a smaller motor and low power-to-energy ratio batteries has nearly the same fuel consumption of a full-size PHEV (and in some cases, can have an even lower fuel consumption), but uses components that can be of lower cost. The biggest disparity in gasoline fuel consumption rates is at low distances (below the all-electric range of the PHEV) over aggressive driving cycles where the engine is often forced to assist when meeting roadloads. Even so, under these conditions, the absolute fuel usage is low ( $\sim 1/9^{\text{th}}$  the fuel consumption of a conventional vehicle for the case of the LA92 cycle).

Furthermore, this study shows that under optimal control, a blended control strategy uses approximately the same amount of fuel as an “electric vehicle centric” approach for known target distances (and constant driving patterns). However, the penalty for “guessing wrong” on the target distance and type of travel can be high for a blended strategy. That is, a control strategy optimally blended to have minimum fuel consumption at a given target distance does not necessarily have the minimum consumption at other distances. Thus, it is typically better to run with an “electric vehicle centric” control strategy that emphasizes using electricity to supply vehicle power demand to the extend possible within the limits of the motor size.

This work was conducted over urban driving cycles for PHEVs with specific energy capacities. Further work should cover other energy capacity sizes and types of driving including the effect of varied driving patterns along a given trip. Additionally, the details of engine on/off including cranking energy and emissions implications should be addressed.

## References

- [1] Bertsekas, Dimitri P., *Dynamic Programming and Optimal Control*, Athens Scientific, 2000
- [2] Lin, Chan-Chiao; Peng, Huei; and Grizzle, Jessy W., *Control System Development for an Advanced-Technology Medium-Duty Hybrid Electric Truck*, Society of Automotive Engineers 2003-01-3369, 2003
- [3] Simpson, Andrew, *Cost-Benefit Analysis of Plug-in Hybrid Electric Vehicle Technology*, EVS-22, 2006
- [4] Python Programming Language, <http://www.python.org>
- [5] Numeric Python and Scientific Python, <http://www.scipy.org>
- [6] Matplotlib Python Extension, <http://matplotlib.sourceforge.net>

## Authors



**Michael Patrick O'Keefe**, Senior Research Engineer, National Renewable Energy Laboratory, 1617 Cole Blvd; Golden, CO 80401 USA; Phone: 303.275.4268; Fax: 303.275.4415; e-mail: michael\_okeefe@nrel.gov. 2000-Present NREL; 1997-2000 MS Mechanical Engineering and MS Inter-engineering: Technical Japanese, University of Washington, USA; 1998 Nippon Steel Corporation, Japan; 1992-1996 BS Mechanical from Northern Arizona University, USA



**Tony Markel**, Senior Research Engineer, National Renewable Energy Laboratory, 1617 Cole Blvd; Golden, CO 80401 USA; Phone: 303.275.4478; Fax: 303.275.4415; e-mail: tony\_markel@nrel.gov. 1996-Present NREL; 2002-2005 MS Mechanical Engineering from University of Colorado, USA; 1995-1996 Argonne National Laboratory; 1991-1995 BSE Mechanical Engineering from Oakland University, USA.

# Summary

## **Summary**

NREL's assessment of PHEV technology has added to the body of knowledge and continues the Vehicle Systems Analysis team's long history of timely, innovative, objective, and quality contributions to advanced vehicle technology development. The President's Advanced Energy Initiative defines the goal of developing a plug-in hybrid vehicle with 40 miles of electric range as a means of changing the way we fuel our vehicles. The PHEV research completed in FY06 explored this and many other potential PHEV design scenarios. PHEV technology has great potential to transition our nation's transportation energy demand away from petroleum. However, finding ways to address the high component costs and narrow the gap between vehicle design and consumer behavior through technology optimization will be critical to achieving the petroleum displacement potential of PHEVs.

NREL will execute a continuation of its PHEV research in FY07. The goal will be to develop and demonstrate potential solutions to technical barriers identified by past research. Emphasis will be placed on fuel economy and emissions test procedures and reporting methods, real-world travel behavior analysis, exploration of alternative economic scenarios, and engine and emissions control system modeling for PHEV duty cycles. These tasks will contribute to the overall FreedomCAR PHEV research plan in the areas of analysis, research and development, and test and validation. Finally, the team plans to continue strengthening its collaborative relationships with industry colleagues. With NREL's contributions and the contributions of others, the auto industry and the U.S. Department of Energy can lead to way toward widespread introduction of PHEV technology.

# REPORT DOCUMENTATION PAGE

Form Approved  
OMB No. 0704-0188

The public reporting burden for this collection of information is estimated to average 1 hour per response, including the time for reviewing instructions, searching existing data sources, gathering and maintaining the data needed, and completing and reviewing the collection of information. Send comments regarding this burden estimate or any other aspect of this collection of information, including suggestions for reducing the burden, to Department of Defense, Executive Services and Communications Directorate (0704-0188). Respondents should be aware that notwithstanding any other provision of law, no person shall be subject to any penalty for failing to comply with a collection of information if it does not display a currently valid OMB control number.

**PLEASE DO NOT RETURN YOUR FORM TO THE ABOVE ORGANIZATION.**

<b>1. REPORT DATE (DD-MM-YYYY)</b> November 2006		<b>2. REPORT TYPE</b> Milestone report		<b>3. DATES COVERED (From - To)</b>	
<b>4. TITLE AND SUBTITLE</b> Plug-In Hybrid Vehicle Analysis				<b>5a. CONTRACT NUMBER</b> DE-AC36-99-GO10337	
				<b>5b. GRANT NUMBER</b>	
				<b>5c. PROGRAM ELEMENT NUMBER</b>	
<b>6. AUTHOR(S)</b> T. Markel, A. Brooker, J. Gonder, M. O'Keefe, A. Simpson, and M. Thornton				<b>5d. PROJECT NUMBER</b> NREL/MP-540-40609	
				<b>5e. TASK NUMBER</b> FC06.2000	
				<b>5f. WORK UNIT NUMBER</b>	
<b>7. PERFORMING ORGANIZATION NAME(S) AND ADDRESS(ES)</b> National Renewable Energy Laboratory 1617 Cole Blvd. Golden, CO 80401-3393				<b>8. PERFORMING ORGANIZATION REPORT NUMBER</b> NREL/MP-540-40609	
<b>9. SPONSORING/MONITORING AGENCY NAME(S) AND ADDRESS(ES)</b>				<b>10. SPONSOR/MONITOR'S ACRONYM(S)</b> NREL	
				<b>11. SPONSORING/MONITORING AGENCY REPORT NUMBER</b>	
<b>12. DISTRIBUTION AVAILABILITY STATEMENT</b> National Technical Information Service U.S. Department of Commerce 5285 Port Royal Road Springfield, VA 22161					
<b>13. SUPPLEMENTARY NOTES</b>					
<b>14. ABSTRACT (Maximum 200 Words)</b> NREL's plug-in hybrid electric vehicle (PHEV) analysis activities made great strides in FY06 to objectively assess PHEV technology, support the larger U.S. Department of Energy PHEV assessment effort, and share technical knowledge with the vehicle research community and vehicle manufacturers. This report provides research papers and presentations developed in FY06 to support these efforts. The report focuses on the areas of fuel economy reporting methods, cost and consumption benefit analysis, real-world performance expectations, and energy management strategies.					
<b>15. SUBJECT TERMS</b> plug-in hybrid electric vehicle; PHEV; transportation; vehicle technologies; hybrids; fuel economy; cost and consumption; real-world performance; energy management; National Renewable Energy Laboratory; NREL					
<b>16. SECURITY CLASSIFICATION OF:</b>			<b>17. LIMITATION OF ABSTRACT</b> UL	<b>18. NUMBER OF PAGES</b>	<b>19a. NAME OF RESPONSIBLE PERSON</b>
<b>a. REPORT</b> Unclassified	<b>b. ABSTRACT</b> Unclassified	<b>c. THIS PAGE</b> Unclassified			<b>19b. TELEPHONE NUMBER (Include area code)</b>

Standard Form 298 (Rev. 8/98)  
Prescribed by ANSI Std. Z39.18